

CAMBRO®

Product Catalog



2020/21



CAMBRO® CATALOG TABLE OF CONTENTS

Equipment



INSULATED TRANSPORT

3

Quick Guide to Delivery and Transport	4
Cambro® GoBags	6
Cam GoBox® Insulated Carriers	11
Pro Cart Ultra®	16
Insulated Food Servers (Electric)	20
Insulated Food Servers (Non-Electric)	26
Transporter Capacity Guide	31
Top-Loading Carriers	34
Camdollies® & Accessories	36
Temperature Maintenance	38
Insulated Beverage Servers	40
Beverage Service Cart	44



WAREWASHING

67

Camrack® 4-in-1 System	68
Camdollies® & Utility Trucks	82
Tray & Dish/Silver Cart	84
S-Series Adjustable	
Dish Caddies	85
Dish Caddies	88
KD Service Cart & KD Utility Cart	89
Service Carts	90
Cambox® Bus Boxes	92



CAMSHELVING® ELEMENTS & BASICS PLUS SERIES

112

Elements Series	
Weight Bearing Chart	113
Elements Series Configurations	114
Elements Series Accessories	118
Basics Plus Series	
Weight Bearing Chart	121
Basics Plus Series Configurations	122
Basics Plus Series Accessories	126
Camshelving Accessories	127



MERCHANDISING

45

Versa Food Service System	46
Food Bar Accessories	49
Table Top Food Bars	50
CamKiosk® System	51
Hand Sink Cart	53
Camcruiser® Vending Carts	54
Camshelving Flex Station	56
Versa Organizers	57
Portable CamBars®	59
Ice Caddies	66



CAMSHELVING® PREMIUM SERIES

93

Key Features	96
Buyers Guide	98
Free Camshelving Design Service	99
Overall Length —	
Quick Reference Guide	100
Camshelving Premium Series	102
Weight Bearing Chart	103
Premium Series Configurations	105
Premium Series Accessories	108
High Density Storage System	109



UTILITY SHELVING

131

Camshelving Ultimate #10 Can Rack System	131
The Ultimate Sheet Pan Rack	134
Premium Series	
Full-Wrap Security Cage	137
Drying and Storage Rack	137
Elements Series 2-Shelf Vented Undercounter Units	139
Premium Series Flex Station	139
Wall Shelves and Shelf Extenders	140
Dunnage Racks	141
Camlink®	141

Supplies



STORAGE

142

Food Storage Containers	143
Food Storage Boxes & Lids	151
StoreSafe® Labels	155
Camwear® Food Pans & Lids	157
H-Pans™	161
High Heat H-Pan™ with Handle(s)	165
Translucent Food Pans	166
ColdFest®	169
Pizza Dough Boxes	170
Ingredient Bins & Scoops	171
Soak and Brine Tank & Camcrisper®	172
High Heat Measuring Cups & Camwear® Measuring Cups	173
Allergen Management	174



DISPLAY

189

Deli Crocks & Platter	190
ShowFest® Display Bowls & Trays	191
Serving Bowls	192
Crocks & Ladles	195
Serving Spoons, Camtensils® & Turners	196
Tongs	197
Shakers/Dredges & Condiment Jars	198
Display Covers & Trays	199

Healthcare



HEALTHCARE

223

Non-Skid Versa Camtrays®	224
Camwear® Trays & Non-Skid Trays	225
Décor Series Epictread™ Camtrays	225
Meal Delivery Ware System	226
Temperature Retention Systems	228
Tumbler, Swirl Bowl & Disposable Camlids®	230
Camduction® Complete Heat System	232
Camtherm® Plate Heater, Reusable CamLids® & Camrack® Wash and Store Rack	233
Air Curtain Ultra™	234
Meal Delivery Carts	235
Airpot & Condiment Station	236
Camshelving® Hygienic Drying Racks	240



TABLE SERVICE

175

Aliso® Barware	176
Cambro Tumblers & Disposable CamLids®	177
Camliter®	181
Pitchers	182
Dinnerware	183
Camcovers®	185
Beverage Dispenser, Pail With Bail & Swirl Bowls®	186
Wine Buckets, Punch Bowls & Bud Vase	187
Personalization	188



TRAYS

200

Trays At A Glance	201
Personalization-Camtrays®	203
Camtrays	204
Camtrays with Handles	206
Décor Series Camtrays	209
Non-Skid Versa Camtrays	210
Camwear® Trays	211
Hotel Room Service Trays	212
Camtread® Trays	213
Treadlite™ & Polytread® Trays	214
Personalization-Camtread	215
Fast Food Trays	216
Market Trays, Pans & Camlite® Trays	217
Compartment Trays	218

GENERAL INFORMATION

Icon Directory	2
Alpha Numeric Listing	242
General Terms	254
Warranty	254
Roto Color Chart	257

PERSONALIZATION

CamKiosks®	52
Camcruisers®	55
Camracks®	80
Table Service / Storage	188
Camtrays®	203
Camtread® Trays	215
Fast Food Trays	216

www.cambro.com

Visit www.cambro.com for a wide variety of information about our products including new product updates, an interactive Camrack Glass to Rack Guide, consultant cut sheets and CAD drawings, care and maintenance product guides and more.

InStock

Cambro's top selling and most frequently used products are InStock. These products are available to ship to Certified Cambro Distributors with their next shipment. Broken cartons are excluded. InStock products are highlighted in gray throughout the Cambro Product Catalog.

The Trademarks of Cambro and product images are the property of Cambro and are subject to the control and ownership of Cambro. Any use thereof is only granted for the promotion and sales of Cambro products and subject to the control of Cambro Manufacturing Company.

the cambro® story

When William and Argyle Campbell first opened the doors at Cambro Manufacturing in 1951, their goal was to make a hospital meal tray of the highest quality possible. Named the Camtray®, it demonstrated that they were as committed to excellence in the food service industry as they were to the quality of their own products. As 2016 marked the company's 65th year of leadership in quality, innovation and customer service, today Cambro serves the world with the industry's most complete selection of products for widely diverse segments of the food service business.

The future is certain to bring great changes to our industry. Yet one thing that will remain a constant is Cambro's tradition of continually developing new products that help food service operators save time and money, increase sales, reduce labor and improve service. In the years ahead, guided by the commitment of its founders to innovation, quality, and value, Cambro Manufacturing will still be the leader in serving the food service industry and you, our valued customer.



ICON DIRECTORY

Throughout the Cambro catalog, please use the following easy-to-identify icons to help explain Cambro product features or services.



Food Safety Matters

For 65+ years, Cambro foodservice equipment and supplies have earned the trust and loyalty of customers and public health professionals alike because our products are designed with Food Safety in mind. At Cambro, every product design is based upon the core principle of food safety.

Look for the Cambro StoreSafe mark throughout the Cambro catalog to identify Cambro storage and transportation products that support safe food handling.

You can learn more about Cambro's Food Safety initiatives at www.cambro.com/storesafe



Many Cambro products may be recycled. For further information, please contact your Cambro representative.



Listed by NSF International, an independent, not-for-profit organization which certifies products that meet their criteria for sanitation and cleanliness.



WARNING: This product can expose you to chemicals including Bisphenol A (BPA), which is known to the State of California to cause birth defects or other reproductive harm. For more information, go to www.P65Warnings.ca.gov.
Warning applies to State of California only.



New Product



Dishwasher Safe



Stackable



Foam Insulation



Pro-rated Warranty.



Not For Use In Heated Carts



Personalization Available
Non-Food Contact Areas Only.



One carton of product is within the weight and cube requirements to be shipped by parcel carrier.

Note: Temperature ranges noted throughout this catalog are based on specific test criteria and provide a general guideline. Individual use may vary due to differences in loading temperatures or ambient temperature.

INSULATED TRANSPORT



QUICK GUIDE TO DELIVERY AND TRANSPORT

Insulated Cambro GoBags®

Thick insulation protects hot or cold foods from kitchen to customer.

Delivery Bags

8 SIZES	2 COLORS
2 PERSONALIZATION TYPES	



Pizza Bags

5 SIZES	2 COLORS
2 PERSONALIZATION TYPES	



Expanded Polypropylene GoBoxes®

Lightweight carriers hold safe hot or cold temperatures for 4+ hours.

Top Loading Cam GoBoxes

8 SIZES	2 SHAPES	1 COLOR
------------	-------------	------------



Front Loading Cam GoBoxes

2 SIZES	1 SHAPE	1 COLOR
------------	------------	------------



Insulated Beverage Servers

Durable, insulated servers keep beverages hot or cold for 4+ hours.

Camtainers®

5 SIZES	2 SHAPES	8 COLORS
------------	-------------	-------------



Top Loading Camcarriers

10 MODELS	12 COLORS
--------------	--------------



Ultra Camtainers

3 SIZES	2 SHAPES	10 COLORS
------------	-------------	--------------



Front Loading Camcarriers for Food Pans

3 MODELS	8 COLORS
-------------	-------------



Camservers®

2 SIZES	3 COLORS
------------	-------------



Front Loading Camcarriers for Sheet Pans and Trays

2 MODELS	7 COLORS
-------------	-------------



QUICK GUIDE TO DELIVERY AND TRANSPORT

Insulated Camcarts®

Durable, insulated carts keep pans, boxes or trays of food hot or cold for 4+ hours.



Camcarts for Food Pans

4 SIZES	11 COLORS
------------	--------------

Camcarts for Sheet Pans, Trays and Food Storage Boxes

5 MODELS	5 COLORS
-------------	-------------



Electric Camcarriers® and Carts for Food Pans

Keep hot foods hot over longer periods of time and with frequent opening.



Ultra Pan Carrier® and Ultra Camcart® H-Series

3 SIZES	5 COLORS	Hot Only CONFIGURATIONS
------------	-------------	----------------------------

Electric Carts for Food Pans and Sheet Pans

These versatile, durable carts can hold hot, cold or both. Energy efficient.



Camtherm®

2 SIZES	5 COLORS	Hot, Cold or Both CONFIGURATIONS
------------	-------------	-------------------------------------



Pro Cart Ultra®

4 MODELS	4 SIZES	Hot, Cold or Both CONFIGURATIONS
-------------	------------	-------------------------------------

CAMBRO® GOBAGS®



Cambro GoBags help protect the signature items your customers crave. Your recipes, your quality, and your brand are delivered to your

customers safe and sound. Thick, sturdy fabric and high-density insulation keep food temperature in the safe zone during both holding

and transport to the customer, whether it's picked up curbside or delivered to their door.



Pizza Bags

Extra long hook and loop fastener for secure closure every time.

Nylon carry handle.

2 Heavy-duty nylon straps.

Reinforced stitching for added durability.

High density insulation.

Superior moisture control and industry leading temperature retention.

Industrial strength nylon exterior is stain resistant and washable.

Large ticket pocket.

Extra large flap for tight seal.



Delivery and Catering Bags

Nylon carry handle.

2 Heavy-duty nylon straps.

Extra long hook and loop fastener on three sides for secure closure every time.

Reinforced stitching for added durability.

Thick, sturdy nylon fabric with heavy-duty insulation.

Large ticket pocket.



CAMBRO® GOBAGS® – PIZZA BAGS



- Thick, sturdy nylon fabric.
- Breathable nylon material protects food quality.
- High-density insulation keeps food hot.
- Heavy-duty, sewn-in straps and ticket pouch.

Premium Pizza Bags



GBPP216

Carries two 16" or three 14" pizza boxes

L 17¼" x W 17½" x H 7½"

LIST PRICE EACH: \$ 170.00

Case Pack: 1

Colors: Black (110), Red (521).

GBPP318

Carries three 18" or four 16" pizza boxes

L 19" x W 20" x H 9"

LIST PRICE EACH: \$ 180.00

Case Pack: 1

Colors: Black (110), Red (521).



Standard Pizza Bags



GBP216

Carries two 16" or three 14" pizza boxes

L 16½" x W 18" x H 6½"

LIST PRICE EACH: \$ 40.00

Case Pack: 4

Colors: Black (110), Red (521).

GBP318

Carries three 18" or four 16" pizza boxes

L 17½" x W 20" x H 7½"

LIST PRICE EACH: \$ 50.00

Case Pack: 4

Colors: Black (110), Red (521).



GBP220

Carries two 20" or three 18" pizza boxes

L 20¾" x W 21¾" x H 6½"

LIST PRICE EACH: \$ 65.00

Case Pack: 4

Colors: Black (110), Red (521).

GBP518

Carries five 18" or six 16" pizza boxes

L 19½" x W 19½" x H 12½"

LIST PRICE EACH: \$ 70.00

Case Pack: 4 Color: Black (110).



GBP1018

Carries ten 18" pizza boxes

L 19" x W 19" x H 23"

LIST PRICE EACH: \$ 125.00

Case Pack: 4 Color: Black (110).



CAMBRO® GOBAGS® – CATERING BAGS



- Thick, sturdy nylon fabric.
- High-density insulation keeps food hot or cold.
- Heavy-duty, sewn-in straps and ticket pouch.



To find the best-fitting delivery bags for your to-go containers, scan here.



GBD101011
Small Folding Delivery Bag
 L 10" x W 10" x H 11"
LIST PRICE EACH: \$ 60.00
Case Pack: 4 Color: Black (110).

GBD121515
Medium Folding Delivery Bag
 L 12" x W 15" x H 15"
LIST PRICE EACH: \$ 85.00
Case Pack: 4 Color: Black (110).

GBD211417
Large Folding Delivery Bag
 L 21" x W 14" x H 17"
LIST PRICE EACH: \$ 110.00
Case Pack: 4 Color: Black (110).



GBD211414
Large Delivery Bag includes vertical, thermal divider
 L 12" x W 14" x H 14"
LIST PRICE EACH: \$ 110.00
Case Pack: 4 Color: Black (110).



GBD13913
Small Top Loading Delivery Bag
 L 13" x W 9" x H 13"
LIST PRICE EACH: \$ 75.00
Case Pack: 4 Color: Black (110), Red (521).

GBD151212
Sandwich Bag
 L 15" x W 12" x H 12"
LIST PRICE EACH: \$ 80.00
Case Pack: 4 Color: Black (110), Red (521).

GBD181412
Jumbo Delivery Bag
 L 18" x W 14" x H 12"
LIST PRICE EACH: \$ 90.00
Case Pack: 4 Color: Black (110), Red (521).

GBD211517
Stadium Delivery Bag
 L 21" x W 15" x H 17"
LIST PRICE EACH: \$ 250.00
Case Pack: 4 Color: Black (110), Red (521).

CAMBRO® GOBAGS® ACCESSORIES AND PERSONALIZATION



Gel Packs

Use for hot or cold temperature retention.



GELHC57
Gel Hot Cold Pack Small
L 5" x W 7"
LIST PRICE EACH: \$ 15.00
Case Pack: 1 Color: (000).

GELHC711
Gel Hot Cold Pack Medium
L 7" x W 11"
LIST PRICE EACH: \$ 20.00
Case Pack: 1 Color: (000).

GELHC1014
Gel Hot Cold Pack Large
L 10" x W 14"
LIST PRICE EACH: \$ 25.00
Case Pack: 1 Color: (000).

Thermal Pads



GBTPSM
Thermal Pad Small
L 10" x W 14½"
LIST PRICE EACH: \$ 98.00
Case Pack: 1 Color: Black (110).

GBTPM D
Thermal Pad Medium
L 14" x W 20½"
LIST PRICE EACH: \$ 101.00
Case Pack: 1 Color: Black (110).

GBTPLG
Thermal Pad Large
L 15½" x W 21½"
LIST PRICE EACH: \$ 109.00
Case Pack: 1 Color: Black (110).

Frames and Liners



GBFSM
GoBag Frame Small
L 13" x W 10" x H 9"
LIST PRICE EACH: \$ 53.00
Case Pack: 1 Color: (000).

GBFMD
GoBag Frame Medium
L 13" x W 9" x H 13"
LIST PRICE EACH: \$ 65.00
Case Pack: 1 Color: (000).

GBFLG
GoBag Frame Large
L 18" x W 14" x H 12"
LIST PRICE EACH: \$ 98.00
Case Pack: 1 Color: (000).

GBLSM
GoBag Liner Small fits GBD13109
L 13½" x W 9½" x H 7½"
LIST PRICE EACH: \$ 98.00
Case Pack: 1 Color: Clear (CLR).

GBLMD
GoBag Liner Medium fits GBD13913
L 14" x W 9½" x H 12½"
LIST PRICE EACH: \$ 101.00
Case Pack: 1 Color: Clear (CLR).

GBLLG
GoBag Liner Large fits GBD181412
L 20½" x W 14" x H 11"
LIST PRICE EACH: \$ 109.00
Case Pack: 1 Color: Clear (CLR).

Personalization

Create a lasting impression of your brand. Cam GoBags can help promote your brand while protecting the safety, temperature and quality of your customers' favorite menu items. Choose from two personalization options. Call 1-800-622-5560 for details.



Heat Transfer Full Color Personalization

Print your logo as large as 12" x 5" on GoBags for Pizza and 12" x 12" on GoBags for Delivery and make a bold, positive impression on your customers.



Embroidery

Add your custom logo, or pick one of our six fonts. Our embroidery lasts longer than iron-on patches and is highly wear-resistant.

CAMBRO® GOBAGS® – BACKPACKS



- High-density insulation maintains safe temperature and food quality.
- Thermal divider separates hot and cold menu items.
- Folds for compact storage.
- Easy to clean.



Side-mounted straps for comfortable hand carrying.

Reflector tape enhances visibility and safety.



2 buckles and hook and loop fastener keep backpack securely closed.

Side pockets hold small items such as condiments and cutlery.

GBBP111417
 Small Cambro GoBag Backpack
 L 11" x W 14" x H 17"
 LIST PRICE EACH: \$ 150.00
 Case Pack: 1 Color: Black (110).

GBBP151417
 Large Cambro GoBag Backpack
 L 15" x W 14" x H 17"
 LIST PRICE EACH: \$ 160.00
 Case Pack: 1 Color: Black (110).

Padded shoulder straps adjust to fit all comfortably.



Removable cellphone pocket.

Adjustable, plastic chest buckle holds backpack in place.



Folds for compact storage.



CAM GOBOX® PROFESSIONAL GRADE INSULATED CARRIERS – TOP LOADERS

Note: Best results will be achieved by loading food pans between 180° to 190°F. Loading metal food pans over 250°F will result in damage to the carrier.



LINE YOUR CAM GOBOX

A Cambro GN Food Pan and Seal Cover or liner are recommended to keep your Cam GoBox clean and sanitary.



EASY LOADING AND UNLOADING

Interior wall recesses make loading and unloading easy for both GN 1/1 as well as 1/2 pans. Straight interior walls allow room for stacking pans inside carrier.

ERGONOMIC HANDLES

Comfortable handles allow easy and safe lifting of the EPP180LHSW GoBox.



OPTIONAL INSERT KIT

For an additional cold boost, use with optional Camchiller Insert Kit. Built-in cut-outs support cold transfer while protecting food from condensation.



STACKABILITY

Cam GoBoxes inter-stack.

Use colored lids for quick content identification or routing.



TEMPERATURE RETENTION

4+ hours

CAM GOBOX® PROFESSIONAL GRADE INSULATED CARRIERS – FRONT LOADERS

4-SIDED HANDLING

Thoughtfully designed built-in handles along the top of front loading models allow them to be easily carried from all four sides.



DRIP-RESISTANT

Built-in condensation barrier helps front loaders to remain drip-resistant.



FULL 270° ACCESS

Durable hinges and latches allow the door to open 270° and remain open securely to the side of the front loader for easy access to products. Latches keep door securely closed during transport.



Note: Best results will be achieved by loading food pans between 180° to 190°F. Loading metal food pans over 250°F will result in damage to the carrier.



GENTLE OPEN AND CLOSE

Beveled door edges ensure door can be easily closed and latched.

STACKABILITY

Cam GoBoxes inter-stack.

LARGE CAPACITY

Cam GoBox front loading carriers are designed with enough room to hold GN 1/1 pans along with Camwarmers® or Camchillers®, if desired.

TEMPERATURE RETENTION

4+ hours

CAM GOBOX® PROFESSIONAL GRADE INSULATED CARRIERS

For Half-Size (GN 1/2) Food Pans



EPP260SW
Holds 1 each 6" deep food pan*
EXTERIOR: L 15.4" x W 13" x H 10"
INTERIOR: L 13" x W 10.6" x H 7.6"
UNIT WEIGHT: 1.37 lbs.
VOLUME: 17.9 qt.
LIST PRICE EACH: \$ 52.00
Case Pack: 1 Color: Black (110).



EPP280SW
Holds 1 each 8" deep food pan*
EXTERIOR: L 15.4" x W 13" x H 12.4"
INTERIOR: L 13" x W 10.6" x H 10"
UNIT WEIGHT: 1.54 lbs.
VOLUME: 23.6 qt.
LIST PRICE EACH: \$ 58.00
Case Pack: 1 Color: Black (110).



EPP280WSTSW
Holds 1 each 8" deep food pan*
EXTERIOR: L 15.4" x W 13" x H 12.4"
INTERIOR: L 13" x W 10.6" x H 10"
UNIT WEIGHT: 1.8 lbs.
VOLUME: 23.6 qt.
LIST PRICE EACH: \$ 66.00
Case Pack: 1 Color: Black (110).



For Full-Size (GN 1/1) or Half-Size (GN 1/2) Food Pans



EPP160SW
Holds 1 each 6" deep food pan*
EXTERIOR: L 23.6" x W 15.7" x H 10"
INTERIOR: L 21.2" x W 13.3" x H 7.7"
UNIT WEIGHT: 2.4 lbs.
VOLUME: 37.5 qt.
LIST PRICE EACH: \$ 78.00
Case Pack: 1 Color: Black (110).



EPP180SW
Holds 1 each 8" deep food pan*
EXTERIOR: L 23.6" x W 15.7" x H 12.4"
INTERIOR: L 21.2" x W 13.3" x H 10"
UNIT WEIGHT: 2.6 lbs.
VOLUME: 48.6 qt.
LIST PRICE EACH: \$ 85.00
Case Pack: 1 Color: Black (110).



EPP180XLTSW
Holds 1 each 8" deep food pan*
EXTERIOR: L 24" x W 17" x H 15.4"
INTERIOR: L 21.6" x W 14.5" x H 12.6"
UNIT WEIGHT: 3.2 lbs.
VOLUME: 68.2 qt.
LIST PRICE EACH: \$ 100.00
Case Pack: 1 Color: Black (110).

Carriers with Colored Lids



EPP180CLSW
Holds 1 each 8" deep food pan*
EXTERIOR: L 23.6" x W 15.7" x H 12.4"
INTERIOR: L 21.2" x W 13.3" x H 10"
UNIT WEIGHT: 2.6 lbs.
VOLUME: 48.6 qt.
LIST PRICE EACH: \$ 94.00
Case Pack: 1 Carrier Color: Black (110). Lid Colors: Red (365), Orange (363), Yellow (361), Green (360), Blue (362).



EPP300
Holds 3 each 4" deep food pans*
EXTERIOR: L 25.2" x W 17.3" x H 18.7"
INTERIOR: L 21" x W 13" x H 14.6"
UNIT WEIGHT: 7 lbs.
VOLUME: 63.4 qt.
LIST PRICE EACH: \$ 296.00
Case Pack: 1 Color: Black (110).



EPP400
Holds 4 each 4" deep food pans*
EXTERIOR: L 25.2" x W 17.3" x H 24.6"
INTERIOR: L 21" x W 13" x H 20.7"
UNIT WEIGHT: 8.6 lbs.
VOLUME: 90.9 qt.
LIST PRICE EACH: \$ 332.00
Case Pack: 1 Color: Black (110).



EPP180LHWS
Holds 1 each 8" deep food pan*
EXTERIOR: L 26.8" x W 15.73" x H 12.6"
INTERIOR: L 21.2" x W 13.9" x H 10"
UNIT WEIGHT: 2.6 lbs.
VOLUME: 48.6 qt.
LIST PRICE EACH: \$ 115.00
Case Pack: 1 Color: Black (110).



*Or equivalent

CAM GOBOX® PROFESSIONAL GRADE INSULATED CARRIERS



For Milk Crates



EPPMBWSTW
 Holds 1 each 13" x 13" x 11" milk crate
EXTERIOR: L 16.1" x W 16.1" x H 16"
INTERIOR: L 13.8" x W 13.8" x H 13"
UNIT WEIGHT: 2.7 lbs.
VOLUME: 42.8 qt
LIST PRICE EACH: \$ 80.00
Case Pack: 1 **Color:** Black (110).



Beverage Holder

Modular beverage holder for transporting hot or cold drinks with ease. Interlocking units connect to hold up to 15 drinks in an EPP180. Holds 8 to 32 oz. hot or cold cups.

CODE	DESCRIPTION	DRINK CAPACITY	LIST PRICE EA.
EPPBEVH1	single holder	3	\$ 6.50
EPPBEVH2	set of 2 holders	6	13.00
EPPBEVH5	set of 5 holders	15	32.50

Exterior Dim.: L 4.5" x W 12.8" x H 4.9"
Case Pack: 1 **Color:** Black (110).

Compartments are tapered to fit multiple cup sizes: 2.8" at bottom graduates to 3.5" at the top.



GOBOX CODE	NUMBER OF DRINKS	NUMBER OF HOLDERS
EPP180	15 (single layer*) 30 (double layer**)	5 (single) 10 (double)
EPP160	15	5
EPP280	6 (single)	2 (single)
EPP260	6	2

*Single layer only recommended for hot cups. Use with Beverage Plugs to prevent spilling during transport.
 **Double layer possible only with 12 oz. or smaller cups.



Camdollies®



CDC300
 Fits EPP400, EPP300, EPP180SW, EPP160SW, UPC300, 1318CC
EXTERIOR: L 24.9" x W 17.3" x H 7.3"
INTERIOR: L 24.5" x W 17"
UNIT WEIGHT: 11.65 lbs.
LOAD CAPACITY: 300 lbs.
LIST PRICE EACH: \$ 185.00
Case Pack: 1 **Color:** Red (358).



CDC400
 Fits EPP180XLTSW, EPP400
EXTERIOR: L 25.3" x W 18.5" x H 6.9"
INTERIOR: L 24.5" x W 18.1"
UNIT WEIGHT: 11.7 lbs.
LOAD CAPACITY: 300 lbs.
LIST PRICE EACH: \$ 210.00
Case Pack: 1 **Color:** Red (358).



CDC400



CDC300

CAM GOBOX® ACCESSORIES

Camchillers®, Camwarmer® and ThermoBarrier®



CP3253

Camchiller GN 1/1 for EPP160SW, EPP180SW, EPP180LHSW, EPP300, EPP400

L 20.9" x **W** 12.8" x **H** 1.2"

UNIT WEIGHT: 8.6 lbs.

LIST PRICE EACH: \$ 83.00

Case Pack: 1 **Color:** Glacier Blue (443).



CP2632

Camchiller GN 1/2 for EPP260SW, EPP280SW, EPP280WSTSW

L 12.8" x **W** 10.4" x **H** 1.2"

UNIT WEIGHT: 3.9 lbs.

LIST PRICE EACH: \$ 63.00

Case Pack: 1 **Color:** Glacier Blue (443).



HP2632

Camwarmer GN 1/2 for EPP260SW, EPP280SW, EPP280WSTSW

L 12.8" x **W** 10.4" x **H** 1.2"

UNIT WEIGHT: 3.8 lbs.

LIST PRICE EACH: \$ 65.00

Case Pack: 1 **Color:** Fire Red (444).



EPP3253DIV

ThermoBarrier for EPP300 & EPP400

L 20.9" x **W** 12.9" x **H** 1.5"

UNIT WEIGHT: 0.8 lbs.

LIST PRICE EACH: \$ 28.00

Case Pack: 1 **Color:** Black (110).

Camchillers Inserts and Kits



EPPCTS

Camchiller Insert for Standard EPP180SW & EPP160SW

EXTERIOR: L 23.6" x **W** 15.7" x **H** 3.4"

INTERIOR: L 21.1" x **W** 13.3" x **H** 1.3"

UNIT WEIGHT: 0.8 lbs.

LIST PRICE EACH: \$ 52.00

Case Pack: 1 **Color:** Black (110).



EPPCTL

Camchiller Insert for EPP180LHSW

EXTERIOR: L 23.8" x **W** 15.7" x **H** 3.4"

INTERIOR: L 21.1" x **W** 13.3" x **H** 1.3"

UNIT WEIGHT: 0.8 lbs.

LIST PRICE EACH: \$ 55.00

Case Pack: 1 **Color:** Black (110).



EPPCTSPKG

Camchiller and Insert all in one package, available for EPP180SW and EPP160SW

L 23.6" x **W** 15.7" x **H** 3.4"

UNIT WEIGHT: 9.4 lbs.

LIST PRICE EACH: \$ 156.00

Case Pack: 1 **Color:** Black (110).



EPPCTLPKG

Camchiller and Large Handle Insert all in one package, available for EPP180LHSW

L 23.6" x **W** 15.7" x **H** 3.4"

UNIT WEIGHT: 9.4 lbs.

LIST PRICE EACH: \$ 159.25

Case Pack: 1 **Color:** Black (110).

Colored Lids

Use lids to color code for quick content identification or routing.



EPP180LID

Colored lid for EPP180SW, EPP160SW

L 23.6" x **W** 15.7" x **H** 1.3"

UNIT WEIGHT: 0.6 lbs.

LIST PRICE EACH: \$ 25.00

Case Pack: 1 **Colors:** Red (365), Orange (363), Yellow (361), Green (360), Blue (362), Black (110).

Plastic ID Labels



EPPID5

Plastic ID labels fits all Cam GoBoxes

LIST PRICE EACH: \$ 9.00

Case Pack: 1 **Color:** (000).



Built-in cutouts support cold transfer while protecting food below from condensation.



PRO CART ULTRA® – ELECTRIC & NON-ELECTRIC INSULATED HOLDING & TRANSPORT CABINETS



The Pro Cart Ultra is the ultimate food transport cart that can hold all your hot and cold menu items in the same cart, at the same time—without a compressor!

- Hold and transport hot and cold foods in a single cart.
- Maintains food quality and moisture.

- Keep food safe while unplugged 4 hours.
- Change hot to cold or cold to hot with a simple hardware change.
- Universal rails fit food pans, sheet pans and more.

Color: Charcoal Gray (615).

Multiple International Certifications available.



ELECTRIC HOT
Hot holding cycles between 150°- 165°F.

NON-ELECTRIC PASSIVE
Holds hot or cold foods for 4+ hours.

ELECTRIC COLD
Cold holding cycles between 32.5°- 40°F without a compressor.

Hot, cold and passive modules are also sold separately to quickly outfit the cart to suit your menu.

Temperature Retention of Passive and Unplugged Electric Models

Hot — temperature loss averaging 3°F/hour.

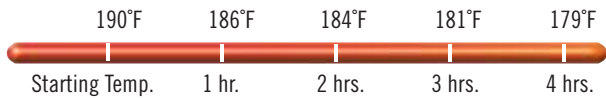

Cold — temperature gain averaging 0.7°F/hour.

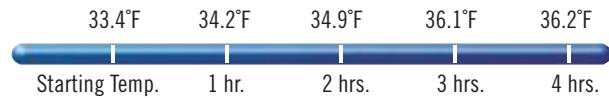

Capacity per Compartment

TYPE OF CONTAINER	STANDARD CAPACITY	STANDARD CAPACITY RAIL SPACING	MAXIMUM CAPACITY	MAXIMUM CAPACITY RAIL SPACING
18" x 26" FULL SIZE SHEET PANS	8	3"	16*	1.5"
13" x 18" HALF SIZE SHEET PANS	16	3"	32*	1.5"
GN 1/1 HOTEL PANS (2½" DEEP)	16	3"	16	3"
GN 1/1 HOTEL PANS (4" DEEP)	10*	4.5"	10	4.5"
60 x 40 cm EURO BAKING SHEETS	8	3"	16*	1.5"
21½" x 13¼" x 2½" BASKETS	16	3"	16	3"
16" x 16" x 2" PIZZA BOXES	8	3"	8	3"

Standard rails: 8 rails / cart *Additional rails required.



Adjustable rails can be set in any position and easily changed when needed.

PRO CART ULTRA® – FEATURES AND TOW HITCH KIT



INSULATION
CFC-free, polyurethane insulation throughout the body and doors maximizes heat or cold retention for 4 hours or more with no electricity needed.



GASKET-FREE DOOR
For easy cleaning and fewer replacement parts. Door opens full 270°.

SOLAR DIGITAL THERMOMETER
Monitor internal cabinet temperature at a glance.

4" NYLON LATCHES AND ADJUSTABLE HINGES
For easy opening and closing and to secure contents during transport. (Door is lockable).



5" x 8" MENU POCKET
Allows for easy product ID with either an index card or by writing directly onto smooth surface with a grease pencil.

STAINLESS STEEL HINGE
For long term durability.

POLYETHYLENE EXTERIOR
Keeps food moist naturally and remains cool to the touch during operation, unlike metal cabinets.

STANDARD 6" x 2" HEAVY DUTY CASTERS
Two non-marking, high-performance, all swivel casters with brakes in the front and two rigid casters in the back for smooth positioning and navigation.

Pro Cart Ultra Tow Hitch Kit

Tow your Pro Cart Ultra to your loading dock, serving location and back to your kitchen with the Cambro Tow Hitch Kit. The tow hitch is designed to securely connect your Pro Cart Ultra to any service vehicle with towing capability.

- Fits all Pro Cart Ultra models, low and tall.
- Kit available with standard or security hardware.
- Maximum tow capacity 2,000 pounds.



CODE	DESCRIPTION	UNIT WEIGHT	LIST PRICE EA.
PCUTOW	Pro Cart Ultra Tow Hitch	35 lbs.	\$ 1,450.00
PCUTOWSP	Pro Cart Ultra Tow Hitch Security Package	35	1,600.00

Case Pack: 1 Color: (000). SP package includes tamper-resistant screws.

PRO CART ULTRA® – ELECTRIC



Powerful Performance, Low Power Consumption

- Energy efficient, active modules draw less than 5 amps each.
- Cold module uses environmentally friendly, thermoelectric technology.
- Plugs into a standard outlet.

COLD

Digital controller allows cold to be set from 32.5° to 40°F.

Thermoelectric Cooling Down to 32.5°F

Cool without a compressor for the ultimate in cold mobility and food safety on the go.

Note: Operate in 90°F or less ambient temperature for best results.

Pre-chill time:

90 minutes to 40°F.

(Tested at 73°F ambient.)

Recovery time:

10 minutes after door open for 30 seconds.



Interior with Cold module



Exterior back with Cold module

HOT

Keeps food safely between 150° to 165°F with convenient, pre-set, gentle, non-radiant heat.

Energy-Saving Heater Less Than 5 Amps

Gentle, non-radiant heat circulates consistently from front to back of the cabinet.

Pre-heat time:

45 minutes.

Recovery time:

3 minutes after door open for 30 seconds.



Interior with Hot module



Exterior back with Hot module

Just 5 Minutes to Change Module

- Seasonal menus
- Menu changes
- Additional budget availability
- Different location or facility
- New trends

Electrical Specifications (Per Compartment)



	HOT 110V	HOT 220V	COLD
REQUIRED VOLTAGE	100-125 VAC	200-230 VAC	100-230 VAC
MAXIMUM AMP	4.6a	2.3a	3.26a, 1.42a
WATTS / HEATER OR COOLER	529w	506w	326.6w
HERTZ	50/60	50/60	50/60
PHASE	Single	Single	Single
ALTERNATE PLUG TYPES FOR INTERNATIONAL*	US, Canada, Mexico, Europe, UK, Ireland, Australia, South Africa, China, Japan		
POWER CORD LENGTH	9 ft.	9 ft.	9 ft.

*If country is not listed, please call Cambro Customer Service for details.



PRO CART ULTRA® – MODEL SPECIFICATIONS



	CODE	DESCRIPTION	UNIT WEIGHT	LIST PRICE EA.
TALL PROFILE  3 = 220V US/CAN/Mexico	Both Compartments Passive (Non-electric)			
	PCUPP	Both compartments non-electric / passive	235.2 lbs.	\$ 6,216.05
	Both Compartments Hot			
	PCUHH	110V standard USA / CAN power cord 5-15P	267.5	8,301.80
	PCUHH3	220V USA / CAN power cord 6-15P	268.4	8,301.80
	Both Compartments Cold			
	PCUCC	110V standard USA / CAN power cord 5-15P	278.4	12,962.55
	PCUCC3	220V USA / CAN power cord 6-15P	283.8	12,962.55
	Combination Hot & Cold			
	PCUHC	Top compartment hot, bottom cold. 110V standard USA / CAN power cord 5-15P	271	11,783.20
	PCUCH	Top compartment cold, bottom hot. 110V standard USA / CAN power cord 5-15P	271	11,783.20
	PCUHC3	Top compartment hot, bottom cold. 220V standard USA / CAN power cord 6-15P	271.4	11,783.20
	PCUCH3	Top compartment cold, bottom hot. 220V standard USA / CAN power cord 6-15P	271.4	11,783.20
	Combination Passive & Hot or Cold			
	PCUPH	Top compartment passive, bottom hot. 110V standard USA / CAN power cord 5-15P	255.3	7,477.80
	PCUPC	Top compartment passive, bottom cold. 110V standard USA / CAN power cord 5-15P	260.8	8,657.15
	PCUPH3	Top compartment passive, bottom hot. 220V standard USA / CAN power cord 6-15P	255.8	7,477.80
	PCUPC3	Top compartment passive, bottom cold. 220V standard USA / CAN power cord 6-15P	263.5	8,657.15
LOW PROFILE 	PCULP	Non-electric / passive	140	3,914.00
	PCULH	Hot Cart, 110V standard USA / CAN power cord 5-15P	151	5,356.00
	PCULC	Cold Cart, 110V standard USA / CAN power cord 5-15P	156	7,416.00
	PCULH3	Hot Cart, 220V standard USA / CAN power cord 6-15P	151	5,356.00
	PCULC3	Cold Cart, 220V standard USA / CAN power cord 6-15P	156	7,416.00

Case Pack: 1 **Color:** Charcoal Gray (615). **Standard Railing Includes:** 8 pairs of stainless steel Universal rails/compartments. Includes Standard Casters: 6" x 2" heavy duty swivel with brake in front, rigid in back.

Unit Dimensions

UNIT	EXTERIOR DIM. W x D x H	COMPARTMENT DIM. W x D x H
Tall Profile		
COLD	28" x 36½" x 66"	21⅞" x 26¼" x 25½"
HOT / PASSIVE	28" x 35¾" x 66"	21⅞" x 27" x 25½"
Low Profile		
COLD	28" x 36½" x 40"	21⅞" x 26¼" x 25½"
HOT / PASSIVE	28" x 35¾" x 40"	21⅞" x 27" x 25½"

Optional Accessories

CODE	DESCRIPTION	LIST PRICE EA.
PCMH / PCMH3	Hot module unit 110V / 220V	\$ 1,670.65
PCMC / PCMC3	Cold module unit 110V / 220V	2,849.00
SSR1	1 Pair of Rails	84.45
SSR8	8 Pairs of Rails	612.85

Case Pack: 1 **Module Unit Color:** Charcoal Gray (615).

Security Package (SP)

Specially designed for operations where safety and security are a top priority. To order add SP after the product code or visit cambro.com for a listing of codes.

- Tamper resistant fasteners secure side column panels to the cart.
- Cross locking rods behind column panels lock 5 rails in place.
- Each compartment holds ten 4" deep hotel pans.
- Passive and electrical modules and cord strap keepers are secured in place with tamper resistant fasteners.
- Non removable doors. Lockable hasp secures both doors at once. (Lock not included).
- Heavy duty casters mounted with tamper resistant fasteners.



All models are also available without rails and side column panels. Please visit cambro.com for details.





Hot Only Models

Go From Hot to Cold in One Versatile Cart!

- Use for bulk food holding in the kitchen or to transport large amounts of food off-site.
- Go from hot to cold with the simple flip of a switch!
- Tough polyethylene exterior will not dent, rust or chip; stays cool to the touch during operation, unlike metal cabinets.
- Thick polyurethane foam insulation maintains safe food holding temperatures for 4 hours or more, even unplugged.
- Available in two sizes and hot only or hot/cold models.

Energy-efficient thermoelectric heating and cooling with:

No Compressor, heating coil or humidifier.

Low voltage, amps, wattage.



48%
More
Energy
Efficient

Than Leading Metal Cabinets



INSULATED FOOD SERVERS (ELECTRIC)

Camtherm® Electric Food Holding Cabinets

KNUCKLE DOOR HINGES

Withstand rigorous door openings, allows door to be lifted up and off for easy cleaning.

DOOR SWINGS OPEN 270°

For easy loading.

MARINE RAILING

Holds 2 full-sized food pans, 1 full-sized sheet pan or cutting board (CB1220).

SOLAR DIGITAL THERMOMETER

Monitor internal temperature at a glance.

SELF-VENTING CAP

Releases steam and equalizes pressure, maintaining food quality.

MENU CLIP

For easy product/event identification.

ADJUSTABLE CHROME-PLATED STEEL SLIDE RAILS

Hold full-size food pans or sheet pans.

POLYETHYLENE EXTERIOR

Stays cool to the touch during operation.

ERGONOMIC MOLDED-IN HANDLES

For easy maneuvering even when fully loaded.

ALUMINUM LOUVERS

Gently circulate hot or cold air evenly.

WIDE NYLON DOOR LATCHES/MAGNETIC DOOR GASKETS

Lock doors securely and create a tight seal to retain safe hot or cold food temperatures.

MOLDED-IN BUMPERS

Protect walls and furniture.

CONTROL PANEL (in back) On/Off switch
Temperature control dial for hot only models.
Hot pre-set between 150° to 165°F.

Hot/Cold switch for Hot/Cold Models only.
Cold pre-set to 37°F.

TRANSITION TIME

Cold to Hot: 1.5 to 2.5 hrs.
Hot to Cold: 3 hrs.

Camtherm® Electrical Specifications



ELECTRICAL SPECIFICATIONS

	LOW PROFILE HOT ONLY	LOW PROFILE HOT/COLD	TALL PROFILE HOT ONLY	TALL PROFILE HOT/COLD
VOLTS	110V	110V	110V	110V
PLUG TYPE	Nema 5-15P	Nema 5-15P	Nema 5-15P	Nema 5-15P
MAXIMUM AMP DRAW	9.1 amps	10.7 amps	14 amps	14.3 amps
AMPS RUN ON	9 amps	10.1 amps	13.8 amps	13.6 amps
WATTS	1035	1162	1587	1570
HERTZ	50/60	50/60	50/60	50/60
POWER INPUT OF HEATING UNIT	110-120 VAC	110-120 VAC	110-120 VAC	110-120 VAC

Assembly is covered by U.S. Patent D 442,756 S & D 6,344,630.

INSULATED FOOD SERVERS (ELECTRIC)

Camtherm® Capacity Specifications

HOLDING CAPACITY	LOW PROFILE	HIGH PROFILE
Sheet Pans		
18" x 26"	11*	22**
Full-Size Food Pans		
2½" Deep	12	24
4" Deep	8	16
6" Deep	6	12
8" Deep	4	8

*Requires five additional rail sets **Requires five additional rail sets.

Security Package







Specially designed for operations where safety and security are a top priority.

- Tamper-resistant fasteners.
- One-piece, welded and secured rail and upright assembly.
- Lockable hasp on each door (padlocks not included).



Product Specifications

CAD drawings, cut sheets and user manual available at www.cambro.com.

	CODE	THERMOMETER	CASTERS	UNIT WEIGHT	LIST PRICE EA.
  	LOW PROFILE				
	EXTERIOR dimensions: W 30½" x D 42" x H 42¾"				
	Hot Only				
	CMBH1826LF	Fahrenheit	2 front 6" swivel w/brake, 2 rear 10" rigid	164 lbs.	\$ 6,452.95
	CMBH1826LC	Celsius	2 front 6" swivel w/brake, 2 rear 10" rigid	164	6,452.95
	Hot/Cold				
	CMBHC1826LF	Fahrenheit	2 front 6" swivel w/brake, 2 rear 10" rigid	222	15,207.95
	CMBHC1826LC	Celsius	2 front 6" swivel w/brake, 2 rear 10" rigid	222	15,207.95
	LOW PROFILE WITH SECURITY PACKAGE (SP)				
	Hot Only				
CMBH1826LSP	Fahrenheit	2 front 6" swivel w/brake, 2 rear 10" rigid	167.4	6,756.80	
Hot/Cold					
CMBHC1826LSP	Fahrenheit	2 front 6" swivel w/brake, 2 rear 10" rigid	225.4	15,558.15	
  	TALL PROFILE				
	EXTERIOR dimensions: W 30½" x D 39" x H 64¾"				
	Hot Only				
	CMBH1826TSF	Fahrenheit	2 front 6" swivel w/brake, 2 rear 6" rigid	250 lbs.	\$ 10,078.55
	CMBH1826TBF	Fahrenheit	2 front 6" swivel w/brake, 2 rear 10" rigid	254	10,078.55
	CMBH1826TSC	Celsius	2 front 6" swivel w/brake, 2 rear 6" rigid	250	10,078.55
	CMBH1826TBC	Celsius	2 front 6" swivel w/brake, 2 rear 10" rigid	254	10,078.55
	Hot/Cold				
	CMBHC1826TSF	Fahrenheit	2 front 6" swivel w/brake, 2 rear 6" rigid	325.5	21,362.20
	CMBHC1826TBF	Fahrenheit	2 front 6" swivel w/brake, 2 rear 10" rigid	330	21,362.20
	CMBHC1826TSC	Celsius	2 front 6" swivel w/brake, 2 rear 6" rigid	325.5	21,362.20
	CMBHC1826TBC	Celsius	2 front 6" swivel w/brake, 2 rear 10" rigid	330	21,362.20
	TALL PROFILE WITH SECURITY PACKAGE (SP)				
Hot Only					
CMBH1826TSP	Fahrenheit	2 front 6" swivel w/brake, 2 rear 10" rigid	260.77	10,634.75	
Hot/Cold					
CMBHC1826TSP	Fahrenheit	2 front 6" swivel w/brake, 2 rear 10" rigid	337	21,954.45	
Cabinet Colors: Granite Gray (191), Granite Green (192), Granite Sand (194).					

ACCESSORIES	CODE	DESCRIPTION	DIMENSIONS L x W x H	CASE PACK	LIST PRICE EA.
	CMBR	Set of slide rails	20" x 4¼"	1 set of 2 Rails	\$ 56.65
	CB1220	Cutting board	21" x 13½" x ½"	1 each	43.25

Cutting Board Color: White (148). Venting plug is covered by US Patent D 553,717 S.

INSULATED FOOD SERVERS (ELECTRIC)

Ultra Pan Carrier® and Ultra Camcart® H-Series

- Designed for both electric hot holding and non-electric transport.
- Gentle, 150° to 165°F non-radiant heat will not cook food and maintains food moisture.
- Holds a wide variety of foods such as pasta, bone-in fried chicken, and double-crusteD pies.

- One hour preheat time from room temperature and three minute recovery.
- Energy consumption is substantially less than comparable metal cabinets.
- Will not rust or dent like metal cabinets, is more economical, and is easy to maneuver.
- All UPCH models have been tested to maintain safe, hot food temperatures, for up to 4 hours when unplugged.
- Models with only the top heated door offer unique versatility with an electric hot holding cabinet on top and passive hot or cold food holding on the bottom.

- Heated door kits also sold separately to retrofit UPC400, UPC800 and UPC1600.

Colors: Granite Gray (191), Granite Green (192), Slate Blue (401), Dark Brown (131), Black (110).

Casters: 6" - 2 fixed, 2 swivel, 1 with brake.



Power On and Heat On Indicators

Communicate the Power and Heating status of the UPCH1600 unit. Know instantly when the compartment has reached target temperature.



Vents

Consistent heating throughout the compartment is generated by vents that constantly circulate heat from front to back.



Tough Exterior

All UPCH units are made of tough polyethylene with polyurethane foam insulation to keep heat in while keeping the exterior cool to the touch. Will not crack, dent, chip, rust or break.



Insulation

CFC-free, foamed-in place polyurethane foam insulation will hold temperature above 148°F for up to 4 hours when used unplugged.

INSULATED FOOD SERVERS (ELECTRIC)

Ultra Pan Carrier® and Ultra Camcart® H-Series

Marine rail is designed for use during service, not transport.



UPCH400 / 4002

UPCH800 / 8002

UPCH1600 / 16002

MODEL	UPCH400/ UPCH800 (110 VAC MODELS)	UPCH4002/ UPCH8002* (220 VAC MODELS)	UPCH1600 (110 VAC MODELS)	UPCH16002* (220 VAC MODELS)
Electrical Specifications				
REQUIRED VOLTAGE	110 – 120 VAC	200 – 230 VAC	110 – 125 VAC	200 – 230 VAC
MAXIMUM AMP.	2.0a	1.2a	4.6a	1.2a
WATTS	230w	265w	529w	265w
HERTZ	50/60	50/60	50/60	50/60
PLUG TYPE	Nema 5-15P	Euro plug, CEE7	5-15P to C15RA	CEE7/7 to C15RA
POWER CORD LENGTH	9 feet	2,7 m	9 feet	2,7 m

*No U.S. 220V model available.

Hot — temperature loss averaging 3°F/hour.

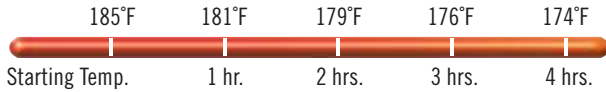

HOT HOLDING	150° — 165°F
WARM UP TIME (from ambient to temperature)	1 hour
RECOVERY TIME* (time to recover to temperature after door is held open for 30 seconds)	3 minutes
TRANSPORT TIME* (after reaching temperature, amount of time unit can be held passively/unplugged until contents reach 148°F.)	4 hours+

*Based on test with 4 full-sized, 4" deep H-Pans™ filled with 190°F hot water.

Capacity Guide

UPCH400
UPCH800 (x2)
UPCH1600 (x4)

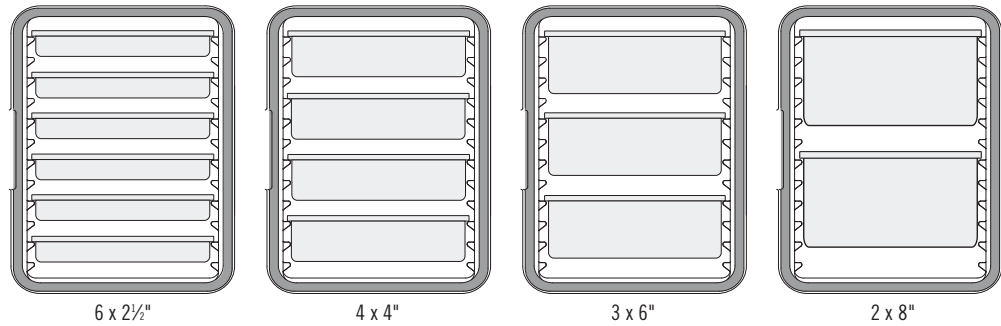

Food Pan Portion Guide

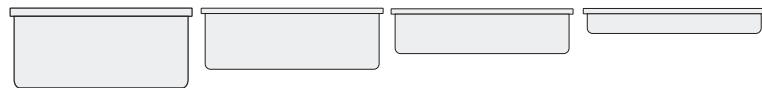

GN 1/1 FOOD PAN	8"	6"	4"	2½"
DEPTH	8"	6"	4"	2½"
SERVING PORTIONS PER PAN (1 CUP)	80	60	40	30

INSULATED FOOD SERVERS (ELECTRIC)

Ultra Pan Carrier® and Ultra Camcart® H-Series

Colors: Granite Gray (191),
Granite Green (192), Slate Blue (401),
Black (110), Dark Brown (131).



- Enables HACCP compliance by maintaining safe, hot food temperatures.
- UPCH400 models stack for storage or transporting on a Camdolly® with securing strap.

Security Package (SP)

Specially designed for operations where safety and security are a top priority.

- Tamper-resistant fasteners.
- Non-removable doors.
- Lockable hasp on each door (padlocks not included).
- Heavy duty (HD) casters with chassis plates mounted with tamper resistant bolts.

CODE	CASTERS	LIST PRICE EA.
UPCH1600SP	6" x 2"	\$ 6,236.65
UPCH16002SP	6" x 2"	6,236.65



CODE	DESCRIPTION	EXTERIOR DIMENSIONS W x D x H	RAIL TO RAIL DIMENSIONS W x D x H	LIST PRICE EA.
1-Compartment Ultra Pan Carriers				
110V				
UPCH400	No casters	18 ³ / ₈ " x 26 ³ / ₈ " x 24 ⁷ / ₈ "	12" x 21" x 19 ¹ / ₈ "	\$ 1,519.25
UPCHW400	With casters	18 ³ / ₈ " x 26 ³ / ₈ " x 31 ¹ / ₄ "	13 ³ / ₈ " x 21" x 19 ¹ / ₈ "	1,725.25
220V*				
UPCH4002	No casters	18 ³ / ₈ " x 26 ³ / ₈ " x 24 ⁷ / ₈ "	13 ³ / ₈ " x 21" x 19 ¹ / ₈ "	1,519.25
UPCHW4002	With casters	18 ³ / ₈ " x 26 ³ / ₈ " x 31 ¹ / ₄ "	13 ³ / ₈ " x 21" x 19 ¹ / ₈ "	1,725.25
2-Compartment Ultra Camcarts				
110V				
UPCH800	Both doors heated	20 ¹ / ₂ " x 27 ¹ / ₈ " x 54"	12" x 21 ¹ / ₂ " x 19 ¹ / ₈ "	3,733.75
UPCHT800	Top door heated only	20 ¹ / ₂ " x 27 ¹ / ₈ " x 54"	13" x 21 ¹ / ₂ " x 19 ¹ / ₈ "	2,842.80
UPCH1600	Both doors heated	28 ³ / ₄ " x 33 ³ / ₈ " x 54 ¹ / ₈ "	19 ³ / ₄ " x 26 ³ / ₈ " x 21"	6,051.25
UPCH1600HD	Both doors heated, HD casters	28 ³ / ₄ " x 33 ³ / ₈ " x 54 ¹ / ₂ "	19 ³ / ₄ " x 26 ³ / ₈ " x 21"	6,221.20
UPCHT1600	Top door heated only	28 ³ / ₄ " x 33 ³ / ₈ " x 54 ¹ / ₈ "	19 ³ / ₄ " x 26 ³ / ₈ " x 21"	4,712.25
UPCHT1600HD	Top door heated only, HD casters	28 ³ / ₄ " x 33 ³ / ₈ " x 54 ¹ / ₂ "	19 ³ / ₄ " x 26 ³ / ₈ " x 21"	4,882.20
220V*				
UPCH8002	Both doors heated	20 ¹ / ₂ " x 27 ¹ / ₈ " x 54"	12" x 21 ¹ / ₂ " x 19 ¹ / ₈ "	3,733.75
UPCHT8002	Top door heated only	20 ¹ / ₂ " x 27 ¹ / ₈ " x 54"	12" x 21 ¹ / ₂ " x 19 ¹ / ₈ "	2,842.80
UPCH16002	Both doors heated	28 ³ / ₄ " x 33 ³ / ₈ " x 54 ¹ / ₈ "	19 ³ / ₄ " x 26 ³ / ₈ " x 21"	6,051.25
UPCH16002HD	Both doors heated, HD casters	28 ³ / ₄ " x 33 ³ / ₈ " x 54 ¹ / ₂ "	19 ³ / ₄ " x 26 ³ / ₈ " x 21"	6,221.20
UPCHT16002	Top door heated only	28 ³ / ₄ " x 33 ³ / ₈ " x 54 ¹ / ₈ "	19 ³ / ₄ " x 26 ³ / ₈ " x 21"	4,712.25
UPCHT16002HD	Top door heated only, HD casters	28 ³ / ₄ " x 33 ³ / ₈ " x 54 ¹ / ₂ "	19 ³ / ₄ " x 26 ³ / ₈ " x 21"	4,882.20
Accessories for 1-Compartment		W x D x H	W x D	
CD400	Camdollies®	21 ¹ / ₁₆ " x 28 ³ / ₈ " x 9"	18 ¹ / ₂ " x 25 ¹ / ₁₆ "	370.80
400STP	150" long strap	—	—	15.45

UPCH Case Pack: 1 *No U.S. 220V model available.

Also Available: Top and Bottom Replacement/Retrofit Doors for 110V and 220V (non-interchangeable).

InStock Colors: Black (110), Dark Brown (131).

Standard Casters: 6" x 1¹/₄" – 2 fixed, 2 swivel, 1 with brake.

Heavy Duty (HD) Casters: 6" x 2" – 2 fixed, 2 swivel with brake.

INSULATED FOOD SERVERS (NON-ELECTRIC)



Multiple GN Food Pan, Front-Loading Carts

- Double-compartment, high-capacity carts hold and transport hot or cold food.
- Tough, polyethylene shell and thick foam insulation throughout cabinet and between compartments maintain safe food temperatures for 4 hours or more.
- Easy to maintain and won't dent, crack, rust, or chip.
- Durable nylon door latches open easily and close securely.
- Full-swing doors open to the side of the cart for easy loading and unloading.
- Airtight removable gaskets
- Molded-in handles ensure easy maneuvering.
- Molded-in bumpers minimize damage to walls, furniture and other equipment.

Colors: Navy Blue (186), Slate Blue (401), Coffee Beige (157), Dark Brown (131), Brick Red (402), Green (519), Black (110), Hot Red (158), Granite Gray (191), Granite Green (192), Granite Sand (194).

Note: Place food pans on rails. Pans should not be placed on the floor of a Camcart cavity. Please use specified food pan sizes.

Note: Best results will be achieved by loading food pans between 180° to 190°F. Loading metal food pans over 250°F may result in damage to the carrier or cart.

Venting plug is covered by US Patent D 553,717 S.



Marine rail is designed for use during service, not transport.



Polyurethane insulation keeps hot food hot and cold food cold.



Shown with optional HD casters.

TOTAL CART HOLDING CAPACITY	UPC600	UPC800	UPC1200	UPC1600
Full Size Food Pans				
2½" deep	8 pans	12 pans	16 pans	24 pans
4" deep	6 pans	8 pans	12 pans	16 pans
6" deep	4 pans	6 pans	8 pans	12 pans
8" deep	2 pans + 2 each 4" pans	4 pans	4 pans	8 pans
Camtray®*				
3253	12 trays	24 trays	24 trays	48 tray
2632	24 trays	48 tray	—	—
2025	—	—	12 trays	24 trays

See Food Pan and Camtray Section for pricing and ordering information.
*Based on 3" spacing between trays.

Hot — temperature loss averaging 3°F/hour.

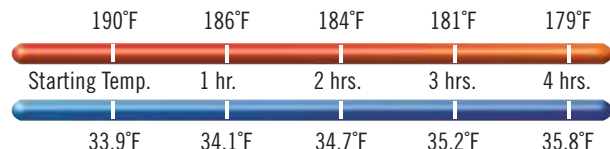

Cold — temperature gain averaging 1.5°F/hour.



INSULATED FOOD SERVERS (NON-ELECTRIC)



Ultra Camcarts®



CODE	UPC600	UPC800 (UPC800SP)	UPC1200
DESCRIPTION	Base model	Base model (Security package)	Base model
EXTERIOR DIM. W x D x H	20½" x 27⅞" x 45"	20½" x 27⅞" x 54"	28½" x 32¼" x 45½"
RAIL TO RAIL DIM. W x D x H	11¾" x 21⅙" x 14"	12" x 21½" x 19⅞"	19¾" x 26⅞" x 13½"
CASTERS	5" x 1¼" casters	6" x 1¼" (6" x 1½" HD casters)	6" x 1¼" casters
TEMPERATURE MAINTENANCE TOOLS	1210PW Camwarmer®, 300DIV ThermoBarrier®, CP1220 and CP1210 Camchiller®	1210PW Camwarmer, 400DIV ThermoBarrier, CP1220 and CP1210 Camchiller	1200DIV Thermo Barrier, CP1220 Camchiller
LIST PRICE EACH	\$ 1,318.40	\$ 1,560.45 (\$ 1,678.90)	\$ 2,029.10

Case Pack: 1 Casters: 5" or 6" x 1¼", 2 fixed, 2 swivel, 1 with brake. **Heavy Duty (HD) Casters:** 6" x 1½", 2 fixed, 2 swivel with brake casters.



Security Package (SP)

Specifically designed for operations where safety and security are a top priority.

- Tamper-resistant fasteners.
- Non-removable doors.
- Lockable hasp on each door (padlocks not included).
- Heavy duty (HD) casters with chassis plates mounted with tamper resistant bolts.



CODE	UPC1600	UPC1600HD	UPC1600SP	UPC6L1600SP
DESCRIPTION	Base model	Base model with HD casters	Security package	Security package, gasketless
EXTERIOR DIM. W x D x H	28¾" x 33⅞" x 54½"	28¾" x 33⅞" x 54½"	28¾" x 33⅞" x 54½"	28¾" x 33⅞" x 54½"
RAIL TO RAIL DIM. W x D x H	19¾" x 26⅞" x 21"	19¾" x 26⅞" x 21"	19¾" x 26⅞" x 21"	19¾" x 26⅞" x 21"
CASTERS	6" x 1¼" casters	6" x 2" HD casters	6" x 2" HD casters	6" x 2" HD casters
TEMPERATURE MAINTENANCE TOOLS	1600DIV ThermoBarrier, CP1220 Camchiller	1600DIV ThermoBarrier, CP1220 Camchiller	1600DIV ThermoBarrier, CP1220 Camchiller	1600DIV ThermoBarrier, CP1220 Camchiller
LIST PRICE EACH	\$ 2,920.05	\$ 3,074.55	\$ 3,187.85	\$ 2,945.80

Case Pack: 1 Casters: 5" or 6" x 1¼", 2 fixed, 2 swivel, 1 with brake. **Heavy Duty (HD) Casters:** 6" x 2", 2 fixed, 2 swivel with brake casters.

INSULATED FOOD SERVERS (NON-ELECTRIC)



Camcarts®

- Use to hold hot or cold bulk food stored on trays/sheet pans or food boxes.
- Durable polyethylene and thick foam insulation retain safe food temperatures.
- Sturdy plastic, rust-proof latches are secured into molded-in mounting plates.
- Molded-in handle on the back for easy maneuvering.



Colors: Slate Blue (401), Coffee Beige (157), Dark Brown (131), Charcoal Gray (615).

6" Casters: 2 fixed, 2 swivel, 1 with brake.

Note: Cool metal sheet pans to 250°F before placing onto tray supports.

Venting plug is covered by US Patent D 553,717 S.

Only 1826DBC and 1826DBCSP are NSF Listed.



1826DTC Double Cavity Cart for Trays and Sheet Pans

Capacity: 24 tray support rails on 1⁵/₁₆" centers (12 per cavity). Holds up to 24 each 18" x 26" trays or sheet pans.

1826DBC Double Cavity Cart for Food Storage Boxes

Capacity: 26 support rails on 1³/₄" centers (13 per cavity). Holds 18" x 26" Food Storage Boxes.

Camcart with Security Package (SP)

Specially designed for high security applications, with tamper-resistant hardware: metal hinges with non-removeable pins, metal latches with welded bails, lockable hasp and chassis plate.



CASTER IMPACT PLATES
Impact plates add metal reinforcement to hold casters in place even when dropped.

CODE	DESCRIPTION	EXTERIOR DIMENSIONS W x D* x H	INTERIOR DIMENSIONS W x D x H	LIST PRICE EA.
1826DTC	For trays & sheet pans	21 ¹ / ₂ " x 33 ³ / ₄ " x 63 ³ / ₄ "	16 ¹ / ₂ x 26 ¹ / ₂ " x 25 ⁷ / ₁₆ "	\$ 2,611.05
1826DBC	For food storage boxes	21 ¹ / ₂ " x 33 ³ / ₄ " x 63 ³ / ₄ "	16 ¹ / ₂ x 26 ¹ / ₂ " x 25 ⁷ / ₁₆ "	2,611.05
Camcarts with Security Package				
1826DTCSP	For trays & sheet pans	21 ¹ / ₂ " x 33 ³ / ₄ " x 63 ³ / ₄ "	16 ¹ / ₂ x 26 ¹ / ₂ " x 25 ⁷ / ₁₆ "	3,321.75
1826DBCSP	For food storage boxes	21 ¹ / ₂ " x 33 ³ / ₄ " x 63 ³ / ₄ "	16 ¹ / ₂ x 26 ¹ / ₂ " x 25 ⁷ / ₁₆ "	3,301.15

Case Pack: 1 *Exterior Depth measurement includes handle.

INSULATED FOOD SERVERS (NON-ELECTRIC)

Camcarriers®

- Holds sheet pans, trays and GN food pans.
- One piece seamless construction with molded-in handles.

Colors: Black (110), Slate Blue (401), Coffee Beige (157), Dark Brown (131), Navy Blue (186), Charcoal Gray (615). 1318CC also available in Hot Red (158).

Refer to Camdollies listing.

Note: Cool metal sheet pans to 250°F before placing onto tray supports.

Venting plug is covered by U.S. Patent D 553,717S.



Combo Carrier

1318CC

Holds half-size sheet pans, trays and a variety of food pan sizes. Safely keeps cold food below 41°F, hot food above 140°F for 4+ hours. Interstacks with UPC300, 300MPC, 1318MTC.

EXTERNAL DIM. W x D x H*: 17" x 25¼" x 22¾"

RAIL TO RAIL DIM. W x D x H: 12" x 21" x 14"

FITS CAMDOLLY: CD300, CD300H, CD300HB, CDC300

LIST PRICE EACH: \$ 540.60

Case Pack: 1 *With Handle.



Camcarrier

1826MTC

Holds up to 6 each 18" x 26" sheet pans. Six tray supports on 2½" centers.

EXTERNAL DIM. W x D x H*: 21½" x 29¼" x 22½"

RAIL TO RAIL DIM. W x D x H: 15" x 26½" x 14½"

FITS CAMDOLLY: CD1826MTC, CD1826MTCHB

LIST PRICE EACH: \$ 810.90

Case Pack: 1 *With Handle.



1826HAR

Lifting harness.

DIMENSION: 142" long

LIST PRICE EACH: \$ 92.70

Color: Beige (000).

Camcarts®

- Holds sheet pans, trays and food boxes.
- Includes removable cutting board on top.
- Security Package (SP)** features tamper-resistant hardware to protect both cart and contents. Includes chassis plates with 6" x 1½" HD Casters.

Colors: Slate Blue (401), Coffee Beige (157), Dark Brown (131), Navy Blue (186), Charcoal Gray (615).

Standard Casters: 6" x 1¼", 2 fixed, 2 swivel, 1 with brake.

Heavy Duty (HD) Casters: 6" x 1½", 2 fixed, 2 swivel, no brake.

Note: Cool metal sheet pans to 250°F before placing onto tray supports.

Venting plug is covered by U.S. Patent D 553,717S.



Camcart for Food Storage Boxes

1826LBC / 1826LBCSP**

Holds 18" x 26" Food Storage Boxes. 13 supports on 1¾" centers.

EXTERNAL DIM. W x D x H: 21½" x 32" x 37½"

RAIL TO RAIL DIM. W x D x H: 16½" x 26½" x 25¼"

LIST PRICE EACH: \$ 1,565.60 / \$ 1,946.70

Case Pack: 1



Camcart for Trays and Sheet Pans

1826LTC / 1826LTCSP**

Holds up to 13 each 18" x 26" trays or sheet pans. 13 tray supports on 1¾" centers.

EXTERNAL DIM. W x D x H: 21½" x 32" x 37½"

RAIL TO RAIL DIM. W x D x H: 14¼" x 26½" x 25¼"

LIST PRICE EACH: \$ 1,581.05 / \$ 1,977.60

Case Pack: 1



Camcart for Trays and Sheet Pans

1826LTC3

Holds up to 7 each 18" x 26" trays or sheet pans. Seven tray supports on 3¾" centers with 3" clearance between trays.

EXTERNAL DIM. W x D x H: 21½" x 32" x 37½"

RAIL TO RAIL DIM. W x D x H: 14¼" x 26½" x 25¼"

LIST PRICE EACH: \$ 1,581.05

Case Pack: 1



INSULATED FOOD SERVERS (NON-ELECTRIC)



Multiple GN Food Pans, Front-loading Carriers

- Holds GN 1/1, GN 1/2 and GN 1/3 pans.
- One-piece seamless construction for great durability.
- Thick polyurethane insulation safely keeps cold food below 41°F, hot food above 140°F for 4+ hours.
- Fully removable door.
- Labeling area on door for adhering ID or routing labels.

Colors: Black (110), Dark Brown (131), Hot Red(158), Navy Blue (186), Slate Blue (401), Charcoal Gray (615).

UPC300 is covered by US Patent D786,607 S.



Recommended labeling with: 23SLINB250 2" x 3" StoreSafe® Labels.



CODE	UPC300
EXTERIOR DIM. W x D x H	17" x 25 $\frac{3}{4}$ " x 22 $\frac{3}{8}$ "
INTERIOR DIM. W* x D x H	13 $\frac{1}{4}$ " x 21" x 14"
UNIT WEIGHT	23.3 lbs.
FITS CAMDOLLY®	CD300, CD300H, CD300HB, CDC300
LIST PRICE EACH	\$ 515.10

Case Pack: 1 InStock Colors: Dark Brown (131), Black (110). *Rail to Rail Temperature Maintenance Tools: 1210PW Camwarmer®, UPC300DIV ThermoBarrier® and CP1220 Camchiller®.

Hot — temperature loss averaging 3°F/hour.

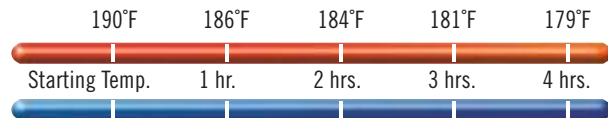

Cold — temperature gain averaging 1.5°F/hour.

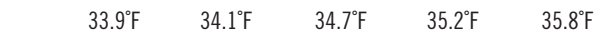

UPC300 Holding Capacity

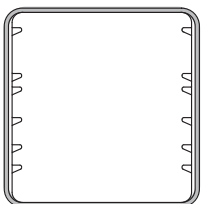

DEPTH	GN 1/1	GN 1/2	GN 1/3
2 $\frac{1}{2}$ "	4	8	12
4"	3	6	9
6"	2	4	6
8"	1	2 + two 4"	3 + three 4"

UPC300 rail configuration

Optional Accessories



CODE	CD300	CD300H
DESCRIPTION	Camdolly	Camdolly with Handles
EXTERIOR DIM.	25 $\frac{1}{2}$ " x 19 $\frac{1}{4}$ " x 10 $\frac{1}{2}$ "	19" x 30 $\frac{1}{2}$ " x 36 $\frac{1}{2}$ "
INTERIOR DIM.	16 $\frac{7}{8}$ " x 23 $\frac{1}{16}$ "	17" x 23 $\frac{1}{2}$ "
LIST PRICE EACH	\$ 334.75	\$ 525.30

Case Pack: 1 Colors: Coffee Beige (157), Dark Brown (131), Black (110), Slate Blue (401).

TRANSPORTER CAPACITY GUIDE

Loading Examples for Cambro® Insulated Transporters

TOP LOADERS

UPC140-UPC180
UPCS140-UPCS180
UPCSS160

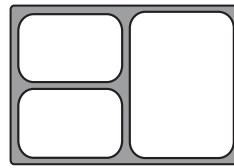
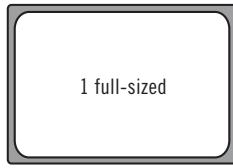

For a 3-course meal:
2 x GN 1/4
1 x GN 1/2
1 DIV12 divider bar
(approx. 14 meals)

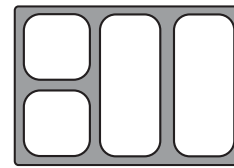

For a 4-course meal:
2 x GN 1/6
2 x GN 1/3
2 DIV12 divider bars
(approx. 14 meals)

TOP LOADERS

100 series
100MPC
UPC100

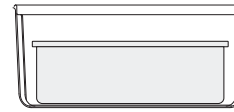
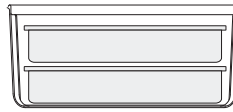
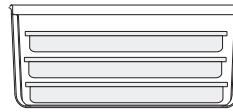

FRONT LOADERS

UPC300
1318CC
UPC600 (x2)
UPC1200 (x4)

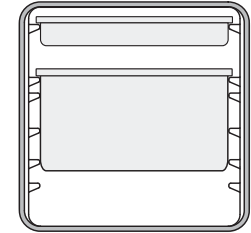
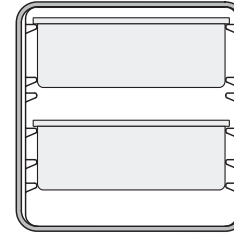
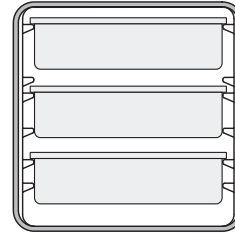
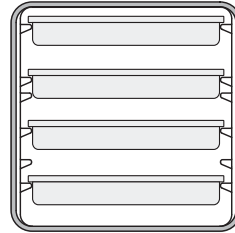

FRONT LOADERS

UPC400
UPCS400
UPCH400(2)
UPC800 (x2)
UPCH800(2) (x2)
UPC1600 (x4)
UPCH1600(2) (x4)

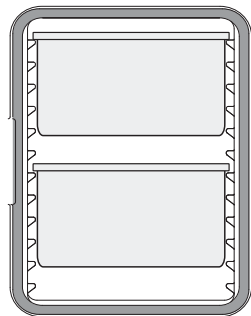
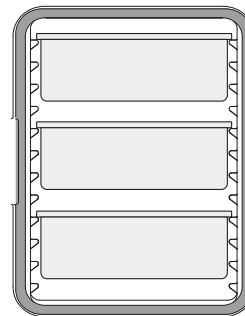
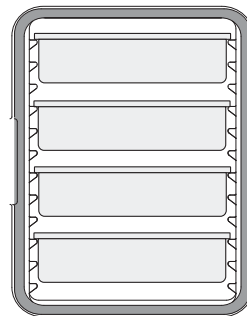
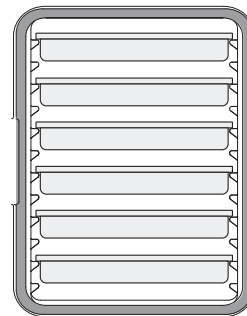

CAMCARRIERS® AND CAMCARTS® FOR SHEET PANS

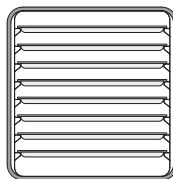

1318CC
1/2 size (x8)
sheet pans



1826MTC
full-size (x6)
sheet pans
1826DTC (x4)

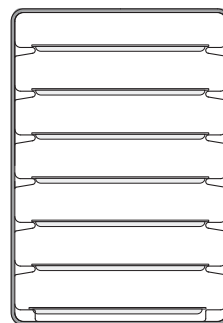

1826LTC3
full-size (x7)
sheet pans

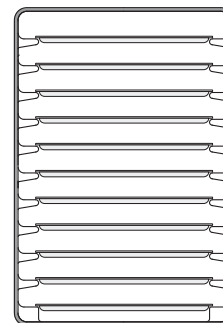

Camtherm Low
full-size (x11)
sheet pans
Camtherm Tall (x2)

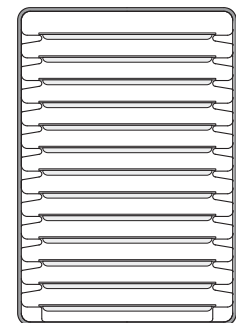

1826LTC
full-size (x13)
sheet pans

SUMMARY OF GN CONTAINER SIZES

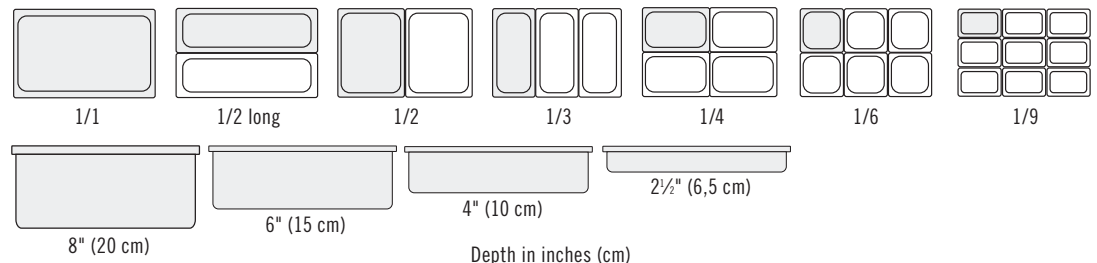

INSULATED FOOD SERVERS (NON-ELECTRIC)



Ultra Pan Carrier® UPC400

- Fit four 4" deep full-size food pans.
- Hold hot or cold food safely for 4 hours or more.

Colors: Navy Blue (186), Slate Blue (401), Coffee Beige (157), Dark Brown (131), Black (110), Granite Gray (191), Granite Green (192), Granite Sand (194).

UPC400 is covered by US Patent D 392,158. Venting plug is covered by US Patent D 553,717 S.

Note: Place food pans on rails. Pans should not be placed on the floor of a Camcarrier® cavity. Please use specified food pan sizes.

Note: Best results will be achieved by loading food pans between 180° to 190°F (82° to 88°C). Loading metal food pans over 250°F (121°C) may result in damage to the carrier or cart.



ERGONOMIC DESIGN

Unbreakable, ergonomic, molded-in handles for comfortable two-person carrying.



PRESSURE AND HUMIDITY CONTROL
Pop-up vent.



TEMPERATURE RETENTION
Polyurethane insulation keeps hot food hot and cold food cold.



QUICK ACCESS
Single, 9" nylon latch for quick and secure opening and closing.

REMOVABLE GASKET

Provides an airtight seal.

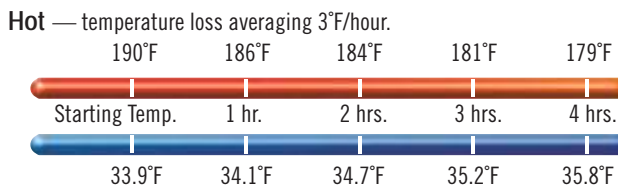

CODE	UPC400 / UPC400SP**
EXTERIOR DIM. W x D x H	18" x 25" x 24 3/8"
INTERIOR DIM. W* x D x H	13 3/8" x 21" x 19 3/8"
UNIT WEIGHT	32 lbs. / 36 lbs.
FITS CAMDOLLY®	CD400, CDC400
LIST PRICE EACH	\$ 606.90 / \$ 673.20

Case Pack: 1 **InStock Colors:** Coffee Beige (157), Black (110). *Rail to Rail
****Security Package (SP) Model:** Tamper-resistant fasteners.
 Non-removable doors. Lockable hasp on each door (padlocks not included).

UPC400 Holding Capacity

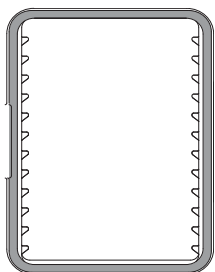

UPC400 rail configuration

HOLDING CAPACITY:

Pan Depth	Number of GN 1/1 pans
2 1/2"	6
4"	4
6"	3
8"	2

Also holds GN 1/2 and 1/3 size pans.

Optional Accessories



CODE	CD400	400STP
DESCRIPTION	Camdolly®	Strap
EXTERIOR DIM.	21 1/16" x 28 3/8" x 9"	150" long
INTERIOR DIM.	18 1/2" x 25 3/16"	—
COLOR	▲	Beige (000)
LIST PRICE EACH	\$ 370.80	\$ 15.45

Case Pack: 1 ▲ **CD400 Colors:** Coffee Beige (157), Dark Brown (131), Black (110), Slate Blue (401).

INSULATED FOOD SERVERS (NON-ELECTRIC)

Ultra Pan Carrier® S-Series UPCS400

- Fit four 4" deep full-size food pans.
- Hold hot or cold food safely for 4 hours or more.

Colors: Slate Blue (401), Speckled Grey (480), Dark Brown (131).

Note: Place food pans on rails. Pans should not be placed on the floor of a Camcarrier® cavity. Please use specified food pan sizes.

Note: Best results will be achieved by loading food pans between 180° to 190°F. Loading metal food pans over 250°F may result in damage to the carrier or cart.



CONVENIENT
Integrated pan-staging area eases service (not for use during transport).

EASY TO CLEAN
Door removes for easy cleaning.



TEMPERATURE RETENTION
Polyurethane insulation keeps hot food hot and cold food cold.



MENU CLIP
Reduces need to open door.

ERGONOMIC DESIGN
Unbreakable, ergonomic, molded-in handles for comfortable two-person carrying.

QUICK ACCESS
Single, 9" nylon latch for quick and secure opening and closing.



BUILT-IN SEAL
Eliminates need for removable gasket.

PRESSURE CONTROL
Built-in vent.

Hot — temperature loss averaging 3°F/hour.

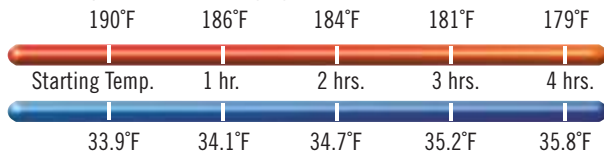

Cold — temperature gain averaging 1.5°F/hour.

CODE

	UPCS400
EXTERIOR DIM. W x D x H	18" x 26¼" x 25"
INTERIOR DIM. W x D x H	13⅞" x 21" x 19⅞"
UNIT WEIGHT	44.3 lbs.
FITS CAMDOLLY	CD400, CDC400
LIST PRICE EACH	\$ 551.05

Case Pack: 1 **InStock Colors:** Speckled Gray (480), Dark Brown (131).

UPCS400 Holding Capacity

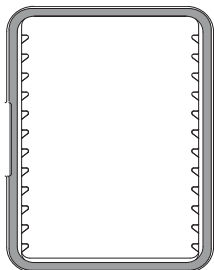

UPCS400 rail configuration

HOLDING CAPACITY:

Pan Depth	Number of GN 1/1 pans
2½"	6
4"	4
6"	3
8"	2

Also holds GN 1/2 and 1/3 size pans.

Optional Accessories



CODE	UPCS400CK	CD400	400STP
DESCRIPTION	Caster Kit*	Camdolly®	Strap
EXTERIOR DIM.	5"	21⅛" x 28⅜" x 9"	150" long
INTERIOR DIM.	—	18½" x 25⅞"	—
COLOR	—	▲	Beige (000)
LIST PRICE EACH	\$ 143.20	\$ 370.80	\$ 15.45

Case Pack: 1 ***Optional Caster Kit for UPCS400:** 2 fixed, 2 swivel, 1 w/ brake.
▲ **CD400 Colors:** Coffee Beige (157), Dark Brown (131), Black (110), Slate Blue (401).

INSULATED FOOD SERVERS (NON-ELECTRIC)



Single GN Food Pan, Top-Loading Carriers

- Top-loading food pan carriers hold, transport and serve a single full-size pan of hot or cold food.
- Sturdy and durable, seamless polyethylene or polypropylene with thick foam insulation.
- Molded-in handles on all four sides for easy carrying and handling.
- 100 Series interstacks within the series and 240MPC stacks only with 240MPCs.
- Use with divider bars to hold multiple fractional pans.
- Pans are easy to remove using finger notches.
- Carriers interlock and stack for transporting and storing.

UPCS Colors: Dark Brown (131), Coffee Beige (157), Speckled Gray (480), Black (110).

MPC and MPCHL Colors: Navy Blue (186), Slate Blue (401), Coffee Beige (157), Dark Brown (131), Brick Red (402), Kentucky Green (519), Black (110), Hot Red (158).

UPC Colors: Slate Blue (401), Dark Brown (131), Black (110), Granite Gray (191), Granite Green (192).

See Food Pan Section and Camdolly Section for pricing and ordering information.

Note: Place food pans on rails. Pans should not be placed on the floor of a Camcarrier® cavity.

Note: Best results will be achieved by loading food pans between 180° to 190°F. Loading metal food pans over 250°F may result in damage to the carrier.



Hot — temperature loss averaging 3°F/hour.

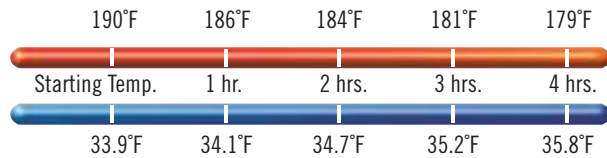

Cold — temperature gain averaging 1.5°F/hour.

UPC140



UPC160
Shown with dividers and fractional sized food pans.

UPC100
No divider bars available for UPC100.

Camcarrier®

One-piece, seamless polyethylene construction, airtight removable gasket and sturdy plastic latches.

CODE	240MPC	100MPCHL
COMPARTMENT CAPACITY	1 half size 2½" deep pan or 1 half size 4" deep pan	1 full size 8" deep pan
EXTERIOR DIM. W x D x H	16½" x 13¾" x 7½"	26¾" x 18" x 15½"
INTERIOR DIM. W x D x H	13¾" x 11⅙" x 4"	21¾" x 13¾" x 8"
BULK CAPACITY*	6.3 qts.	40 qts.
FITS CAMDOLLY®	CD1420	CD100, CD100H, CD100HB
LIST PRICE EACH	\$ 306.00	\$ 550.80

Case Pack: 1 *Without using food pans. 240MPC and 100MPCHL No Divider Bar.

INSULATED FOOD SERVERS (NON-ELECTRIC)

S-Series

Durable polypropylene construction, built in seal and wide, nylon latches.
Contemporary appearance and superior holding performance at an economical price.



CODE	UPCS140	UPCS160*	UPCS180
COMPARTMENT CAPACITY	1 full size 4" deep pan	1 full size 6" deep pan	1 full size 8" deep pan
EXTERIOR DIM. W x D x H	25 $\frac{1}{8}$ " x 17 $\frac{1}{8}$ " x 8 $\frac{1}{2}$ "	25 $\frac{1}{8}$ " x 17 $\frac{1}{8}$ " x 10 $\frac{1}{4}$ "	25 $\frac{1}{8}$ " x 17 $\frac{1}{8}$ " x 12"
FITS CAMDOLLY®	CD160	CD160	CD160
LIST PRICE EACH	\$ 278.10	\$ 288.40	\$ 309.00

Case Pack: 1 *UPCS160 Cannot be used with Camchiller.

Ultra Pan

One-piece, seamless polyethylene construction, airtight removable gasket and wide, nylon latches.



CODE	UPC140	UPC160	UPC180
COMPARTMENT CAPACITY	1 full size 4" deep pan	1 full size 6" deep pan	1 full size 8" deep pan
EXTERIOR DIM. W x D x H	24 $\frac{3}{8}$ " x 17 $\frac{3}{8}$ " x 8 $\frac{1}{2}$ "	24 $\frac{3}{8}$ " x 17 $\frac{3}{8}$ " x 10 $\frac{1}{4}$ "	24 $\frac{3}{8}$ " x 17 $\frac{3}{8}$ " x 12"
FITS CAMDOLLY	CD100H, CD1826HB, CD160	CD100H, CD1826HB, CD160	CD100H, CD1826HB, CD160
LIST PRICE EACH	\$ 417.15	\$ 422.30	\$ 432.60

Case Pack: 1

Multiple Stackable GN Food Pans, Top-Loading Carriers

100 Series

Store and stack food pans or place packaged food directly in compartment.



CODE	100MPC	UPC100
COMPARTMENT CAPACITY	3 full size 2 $\frac{1}{2}$ " deep pans or 2 full size 4" deep pans or 1 full size 6" or 8" deep pan	3 full size 2 $\frac{1}{2}$ " deep pans or 2 full size 4" deep pans or 1 full size 6" or 8" deep pan
EXTERIOR DIM. W x D x H	26 $\frac{3}{8}$ " x 18" x 15"	26 $\frac{5}{8}$ " x 18" x 15 $\frac{3}{4}$ "
INTERIOR DIM. W x D x H	21 $\frac{3}{4}$ " x 13 $\frac{3}{4}$ " x 8"	22 $\frac{1}{4}$ " x 13" x 8"
BULK CAPACITY*	40 qts.	40 qts.
FITS CAMDOLLY	CD100H, CD1826MTC, CD100HB, CD1826MTCHB, CD100, CD2028	CD100H, CD1826MTC, CD100HB, CD1826MTCHB, CD100, CD2028
LIST PRICE EACH	\$ 438.60	\$ 468.65

Case Pack: 1 *Without using food pans. 100MPC and UPC100 No Divider Bar.

Accessories

CODE	OVERALL EXTERIOR	LIST PRICE EA.
Divider Bars for Food Pans		
DIV12	12 $\frac{3}{4}$ " length	\$ 4.35
Case Pack: 3	Colors: White (148), Clear (135).	



CAMDOLLIES® FOR INSULATED BEVERAGE SERVERS AND CARRIERS

With Handles



CD100H
EXTERNAL DIM. W x D x H:
 19½" x 33½" x 36¼"
INTERIOR DIM. W x D:
 17⅝" x 26⅜"
CAPACITY: 350 lbs.
CASTER TYPE: A
FITS: 250LCD, 350LCD,
 500LCD, UC250, UC500,
 100MPCHL, UPC140,
 UPC160, UPC180, 100MPC,
 300MPC, UPC100, UPC300,
 UPCS140, UPCS160,
 UPCS180, UPCSS160
LIST PRICE EACH: \$ 535.60



CD300H
EXTERNAL DIM. W x D x H:
 19" x 30½" x 36½"
INTERIOR DIM. W x D:
 17" x 23½"
CAPACITY: 350 lbs.
CASTER TYPE: A
FITS: 1000LCD, UC1000,
 UPC300, 300MPC, 1318CC,
 1318MTC, 250LCD, 350LCD,
 500LCD, UC250, UC500,
 UPCS140, UPCS160,
 UPCS180, UPCSS160
LIST PRICE EACH: \$ 525.30



CD1826H
EXTERNAL DIM. W x D x H:
 20" x 31½" x 38¼"
INTERIOR DIM. W x D:
 18" x 26"
CAPACITY: 300 lbs.
CASTER TYPE: A
FITS: 250LCD, 350LCD,
 500LCD, 1000LCD, UC250,
 UC500, UC1000, 100MPC,
 300MPC, UPC300, UPCS140,
 UPCS160, UPCS180,
 UPCSS160
LIST PRICE EACH: \$ 566.50



CD1826MTC
EXTERNAL DIM. W x D x H:
 23⅝" x 35⅝" x 36⅜"
INTERIOR DIM. W x D:
 21⅝" x 28⅜"
CAPACITY: 350 lbs.
CASTER TYPE: A
FITS: 100MPC, UPC100,
 UPC400, 1826MTC
LIST PRICE EACH: \$ 618.00



CD2020H
EXTERNAL DIM. W x D x H:
 22⅞" x 25⅝" x 36⅝"
INTERIOR DIM. W x D:
 20⅞" x 20⅞"
CAPACITY: 350 lbs.
CASTER TYPE: B
FITS: 250LCD, 350LCD,
 500LCD, 1000LCD, UC1000
LIST PRICE EACH: \$ 484.10



Big Rear Wheels



CD100HB
EXTERNAL DIM. W x D x H:
 23⅞" x 32⅞" x 36⅞"
INTERIOR DIM. W x D:
 18" x 27"
CAPACITY: 350 lbs.
CASTER TYPE: C
FITS: 250LCD, 350LCD,
 500LCD, 1000LCD, UC250,
 UC500, UC1000, 100MPCHL,
 100MPC, UPC100, UPC300,
 300MPC
LIST PRICE EACH: \$ 648.90



CD300HB
EXTERNAL DIM. W x D x H:
 23½" x 29⅞" x 36½"
INTERIOR DIM. W x D:
 17" x 23⅞"
CAPACITY: 350 lbs.
CASTER TYPE: C
FITS: 250LCD, 350LCD,
 500LCD, 1000LCD, UC250,
 UC500, UC1000, 300MPC,
 1318MTC, UPC300, 1318CC,
 UPCS140, UPCS160,
 UPCS180, UPCSS160
LIST PRICE EACH: \$ 623.15



CD1826HB
EXTERNAL DIM. W x D x H:
 23½" x 32½" x 36½"
INTERIOR DIM. W x D:
 18½" x 26¼"
CAPACITY: 300 lbs.
CASTER TYPE: C
FITS: 250LCD, 350LCD,
 500LCD, UPC140, UPC160,
 UPC180, 300MPC, 1318MTC,
 UPC300, 1318CC, UPCS140,
 UPCS160, UPCS180,
 UPCSS160
LIST PRICE EACH: \$ 700.40



CD1826MTCHB
EXTERNAL DIM. W x D x H:
 27⅝" x 35" x 36¾"
INTERIOR DIM. W x D:
 21⅝" x 28⅝"
CAPACITY: 350 lbs.
CASTER TYPE: C
FITS: 1000LCD, UC1000,
 100MPC, UPC100, UPC400,
 1826MTC
LIST PRICE EACH: \$ 777.65



CD2020HB
EXTERNAL DIM. W x D x H:
 26¼" x 26½" x 36⅝"
INTERIOR DIM. W x D:
 20½" x 20⅞"
CAPACITY: 350 lbs.
CASTER TYPE: C
FITS: 250LCD, 350LCD,
 500LCD
LIST PRICE EACH: \$ 623.15



CAMDOLLIES® FOR INSULATED BEVERAGE SERVERS AND CARRIERS

Without Handles



CD100
EXTERNAL DIM. W x D x H:
 19⁵/₈" x 28⁵/₈" x 10¹/₂"
INTERIOR DIM. W x D:
 17³/₁₆" x 26³/₁₆"
CAPACITY: 300 lbs.
CASTER TYPE: A
FITS: 250LCD, 350LCD, 500LCD,
 UC250, UC500, 100MPCHL, 100MPC,
 300MPC, UPC300, UPC100, UPCS140,
 UPCS160, UPCS180, UPCSS160
LIST PRICE EACH: \$ 334.75



CD160
EXTERNAL DIM. W x D x H:
 16⁷/₁₆" x 24¹/₂" x 10³/₈"
INTERIOR DIM. W x D:
 14¹/₄" x 22¹/₄"
CAPACITY: 300 lbs.
CASTER TYPE: A
FITS: UPCS140, UPCS160, UPCS180,
 UPCSS160, UPC140, UPC160,
 UPC180
LIST PRICE EACH: \$ 334.75



CD300
EXTERNAL DIM. W x D x H:
 25¹/₂" x 19¹/₄" x 10¹/₂"
INTERIOR DIM. W x D:
 16⁷/₈" x 23¹/₁₆"
CAPACITY: 350 lbs.
CASTER TYPE: A
FITS: 1000LCD, UC1000, 300MPC,
 1318MTC, UPC300, 1318CC,
 UPCS140, UPCS160, UPCS180,
 UPCSS160
LIST PRICE EACH: \$ 334.75



CD400
EXTERNAL DIM. W x D x H:
 21¹/₁₆" x 28³/₈" x 9"
INTERIOR DIM. W x D:
 18¹/₂" x 25⁵/₁₆"
CAPACITY: 300 lbs.
CASTER TYPE: A
FITS: UPCS400, UPC400
LIST PRICE EACH: \$ 370.80



CDC300
EXTERNAL DIM. W x D x H:
 17⁵/₁₆" x 24⁷/₈" x 7³/₁₆"
INTERIOR DIM. W x D:
 17¹/₁₆" x 24⁵/₁₆"
CAPACITY: 300 lbs.
CASTER TYPE: D
FITS: EPP400, EPP300, UPC300,
 EPP180SW, EPP160SW
LIST PRICE EACH: \$ 185.00



CDC400
EXTERNAL DIM. W x D x H:
 18¹⁵/₃₂" x 25¹/₄" x 6⁷/₈"
INTERIOR DIM. W x D:
 18¹/₂" x 25"
CAPACITY: 300 lbs.
CASTER TYPE: D
FITS: UPC400, EPP180XLTSW
LIST PRICE EACH: \$ 210.00



CD1420
EXTERNAL DIM. W x D x H:
 16¹/₄" x 21³/₄" x 8⁵/₁₆"
INTERIOR DIM. W x D:
 13³/₈" x 19¹/₁₆"
CAPACITY: 350 lbs.
CASTER TYPE: B
FITS: 100LCD
LIST PRICE EACH: \$ 303.85



CD2020
EXTERNAL DIM. W x D x H:
 22¹/₂" x 22¹/₂" x 8¹/₄"
INTERIOR DIM. W x D:
 20⁷/₈" x 20¹/₈"
CAPACITY: 300 lbs.
CASTER TYPE: B
FITS: 250LCD, 350LCD, 500LCD,
 1000LCD, UC1000
LIST PRICE EACH: \$ 309.00



CD2028
EXTERNAL DIM. W x D x H:
 21¹/₈" x 30¹/₄" x 8¹/₄"
INTERIOR DIM. W x D:
 19¹/₂" x 27¹/₈"
CAPACITY: 350 lbs.
CASTER TYPE: B
FITS: 100MPC, UPC100, 300MPC,
 UPC300, UPC400
LIST PRICE EACH: \$ 319.30



Camdolly® Colors:
 Coffee Beige (157), Dark Brown (131),
 Black (110), Slate Blue (401).
CDC300 and CDC400 Color: Red (358).
CD400 InStock Colors:
 Black (110), Dark Brown (131).
Caster Type:
(A) 5" Casters, 2 fixed, 2 swivel,
 1 with brake.
(B) 3" Casters, 4 swivel, no brakes.
(C) 10" Rear Big Wheels, 2 front 5" swivel
 casters, 1 with brake.
(D) 4" Casters, 4 swivel 2 with brake.

Optional Accessories



400STP (STRAP)
DIMENSION: 150" Long
LIST PRICE EACH: \$ 15.45

UTHSTP (STRAP)
DIMENSION: 200" long
LIST PRICE EACH: \$ 17.50



1826HAR (LIFTING HARNESS)
DIMENSION: 142" long
LIST PRICE EACH: \$ 92.70

TEMPERATURE MAINTENANCE TOOLS



Camchiller®

- An easy-to-use, cold food holding temperature tool.
- Extend cold holding time or enhance safe holding below 41°F when frequent access is required.
- Freeze first then use to pre-chill cabinet before loading.



Cold — temperature gain averaging 1.5°F/hour.

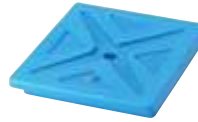
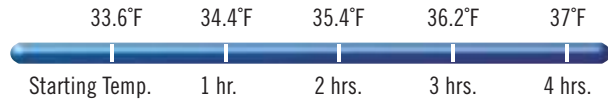

CODE	CP1220 GN Full Size	CP1210 GN Half Size	CP814 Camchiller 8 x 14
FITS INTO	Insulated Transporters: UPC300, 300MPC, 1318CC, 1318MTC, UPC400, UPCS400, UPC100, UPC600, UPC800, UPC1200, UPC1600, UPCSS160 Camcruisers®: CVC72*, CVC724* Combo Carts™: All Models CamKiosk®*: All Models	Insulated Transporters: UPC300, 300MPC, 1318CC, 1318MTC, UPC140, UPC160, UPC180, UPC400, UPCS400, UPC600, UPC800, UPCS140, UPCS160, UPCS180 Camcruisers®: CVC72*, CVC724* CamKiosk®*: All Models	Food Boxes: 12189CW, 12189P, 12186CW, 12186P Camcruisers®: CVC55, CVC72*, CVC724* CamKiosk®*: All Models
DIMENSIONS L x W x H	20 ⁷ / ₈ " x 12 ⁷ / ₈ " x 1 ¹ / ₂ "	10 ⁷ / ₈ " x 12 ³ / ₄ " x 1 ¹ / ₂ "	14" x 8" x 1 ¹ / ₂ "
LIST PRICE EACH	\$ 144.20	\$ 75.20	\$ 73.00

Case Pack: 1 Color/InStock Color: Cold Blue (159). *Top wells only.

ThermoBarrier®

- Use to minimize empty space and food temperature loss within a partially loaded compartment.



CODE	UPC300DIV	300DIV	400DIV	1200DIV	1600DIV
FITS INTO	UPC300, 1318CC	300MPC, 1318MTC, UPC600	UPC400, UPC800, UPC400SP, UPCS400, UPC800SP	UPC1200, CVC72, CVC724	UPC1600, CamKiosk
DIMENSIONS L x W x H	20 ⁷ / ₈ " x 12 ¹⁵ / ₁₆ " x 1"	20 ¹³ / ₁₆ " x 12 ¹⁵ / ₁₆ " x 1"	21 ¹ / ₄ " x 13" x 1 ¹ / ₂ "	20 ⁷ / ₈ " x 12 ⁷ / ₈ " x 1 ³ / ₈ "	20 ⁷ / ₈ " x 13 ³ / ₈ " x 1 ¹ / ₂ "
COLOR	Charcoal Gray (615)	Coffee Beige (157)	Gray (180)	Dark Brown (131)	Slate Blue (401)
CASE PACK	1	1	1	2	2
LIST PRICE EACH	\$ 80.35	\$ 80.35	\$ 80.35	\$ 91.65	\$ 91.65

InStock Models: UPC300DIV and 400DIV.

Camwarmer®

- Added insurance to keep hot foods hot during holding and transporting.

- Keep in cabinet with hot foods to extend holding time or enhance safe holding above 140°F when frequent access is required.



CODE	1210PW	HP2632
FITS INTO	UPC300, 300MPC, 1318CC, 1318MTC, UPC400, UPCS400, UPC600, UPC800	UPC300, 300MPC, 1318CC, 1318MTC, UPC140, UPC160, UPC180, UPC400, UPCS400, UPC600, UPC800, UPCS140, UPCS160, UPCS180
DIMENSIONS L x W x H	13 ³ / ₄ " x 10 ⁷ / ₈ " x 1 ¹ / ₁₆ "	12.8" x 10.4" x 1.2"
COLOR	Granite Gray (191)	Fire Red (444)
LIST PRICE EACH	\$ 200.15	\$ 65.00

Case Pack: 1 InStock Color: Granite Gray (191).

UPC400 with Camwarmer.
Two Camwarmers recommended per cavity. Place on bottom rail and store hot food above.

TEMPERATURE MAINTENANCE – OPTIMIZE FOOD HOLDING PERFORMANCE

Camchiller® – GN Full Size and Half Size

- Use to:
 - Pre-chill cabinet cavity.
 - Hold packaged food in food pan wells (Half Size Only).
 - Maximize cold food holding.
 - Minimize open cavity space.
- Easy to use:
 1. Freeze flat for 8 hours.
 2. Slide one or two on top rails and pre-chill cavity 15-20 minutes.
 3. Load in pans of pre-chilled food below Camchiller. (A)
 4. Move pans and Camchiller down as food is removed. (B)

COLD HOLDING

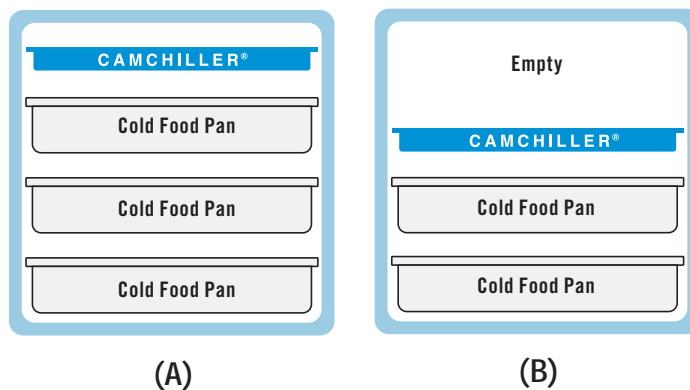

ThermoBarrier® – Full Size

- Use to:
 - Hold hot and cold food in same cabinet cavity.
 - Minimize open cavity space.
- Easy to use:
 1. Slide between hot food on top and cold food on bottom. (A)
 2. Slide under hot food loaded in upper cavity space. (B)
 3. Slide above cold food loaded into lower cavity space. (C)

HOT AND COLD HOLDING

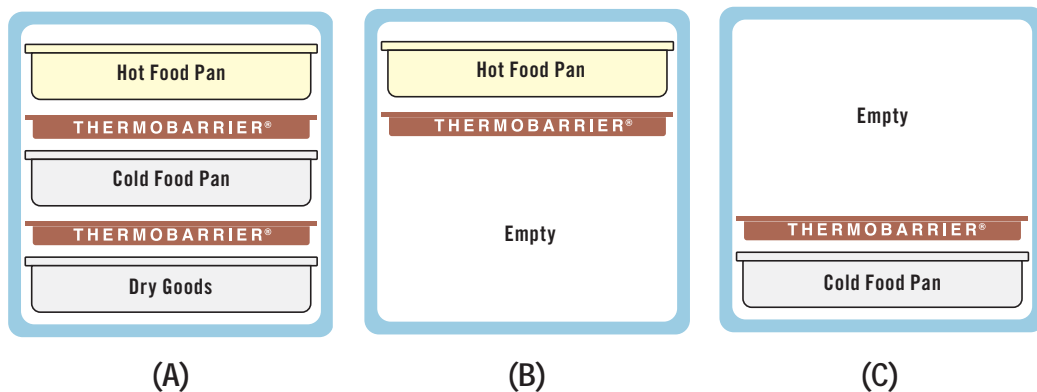

Camwarmer® – Half Size

- Use to:
 - Pre-heat cabinet cavity.
 - Maximize hot food holding.
 - Minimize open cavity space.
- Easy to use:
 1. Heat in 350°F oven for 45 min.
 2. Slide two Camwarmers on bottom rails and pre-heat cavity 15-20 minutes (or place on high heat food pan lid or sheet pan).
 3. Load in pans of pre-heated food above Camwarmers. (A)
 4. Move pans and Camwarmers up as food is removed. (B)

HOT HOLDING

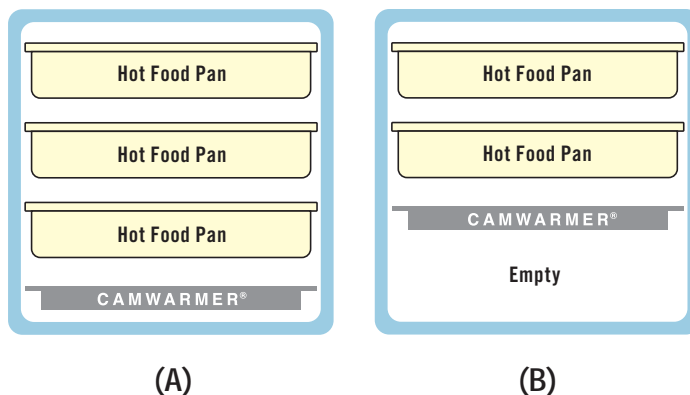



Insulated Beverage Servers

- Use to hold, transport and serve hot or cold beverages for up to 4 hours.
- Pre-heat or pre-chill before use to guarantee maximum operational efficiency.
- Sturdy latches secure lids tightly and will never rust.
- Drip-proof recessed spigot for easy self-serve access.
- Molded-in metal backing plates prevents latches from breaking away from the container.

INSULATED BEVERAGE SERVERS

Insulated Beverage Servers

- Stack units on riser to fill large cups or coffee pots.
- Stack interlocking ensures stable stacking during transport and storage.

UC1000 covered by U.S. Patent D 403,916.



Stacking options:

- 100LCD with 100LCD
- All 250, 350 and 500 units
- UC1000 and 1000LCD

Hot — temperature loss averaging 3°F/hour.

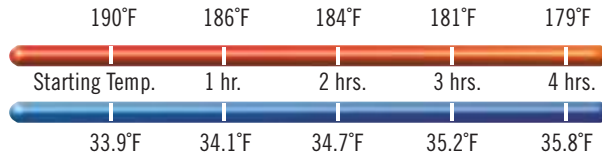

Cold — temperature gain averaging 1.5°F/hour.



Camtainer Cover

Durable and attractive covers dress up and extend the life of your Camtainers.

Personalization available: \$15.00 net per cover, less than 12 covers. 12 or more, FREE! Contact your Cambro representative for more details. (Models for covers on next page.)



Vent Cap

Equalizes pressure. Makes opening the container much easier.



Recessed Faucet

Accommodates larger cups. Allows even dispensing and eliminates drips. Two positions: One for continuous pouring and one for individual dispensing.



Molded-in Metal Backing Plates

Prevents latches from breaking away from the container.



Ultra Camtainers®

Feature wide nylon latches which are easy to open and close with one hand.



Camtainers®

Feature sturdy plastic latches that secure lids tightly and will never rust.

INSULATED BEVERAGE SERVERS



Camtainers®

The standard for many caterers. Four sturdy plastic latches on each unit open and close easily and will never rust.



CODE	100LCD	250LCD	500LCD	1000LCD	350LCD Soup
CAPACITY	1½ gal.	2½ gal.	4¾ gal.	11¾ gal.	3¾ gal.
7 OZ. CUPS	27	45	86	214	61
SPIGOT	YES	YES	YES	YES	—
EXTERIOR DIM. W x D x H	10¾" x 11½" x 17¼"	9" x 16½" x 18¾"	9" x 16½" x 24¼"	16¼" x 20¾" x 24¼"	9" x 16½" x 18¾"
FITS CAMDOLLY®	CD1420	CD100H, CD1826H, CD300H, CD2020H, CD100HB, CD300HB, CD1826HB, CD2020HB, CD100, CD2020	CD100H, CD1826H, CD300H, CD2020H, CD100HB, CD300HB, CD1826HB, CD2020HB, CD100, CD2020	CD300H, CD1826H, CD2020H, CD100HB, CD300HB, CD1826MTCHB, CD300, CD2020	CD100H, CD1826H, CD300H, CD2020H, CD100HB, CD300HB, CD1826HB, CD2020HB, CD100, CD2020
LIST PRICE EACH	\$ 239.70	\$ 249.90	\$ 285.60	\$ 438.60	\$ 244.80
CAMTAINER COVER	—	250LCDCVR: \$ 130.00	500LCDCVR: \$ 130.00	1000LCDCVR: \$ 130.00	—

Case Pack: 1 Colors: Navy Blue (186), Slate Blue (401), Coffee Beige (157), Dark Brown (131), Brick Red (402), Kentucky Green (519), Black (110), Hot Red (158). **InStock Colors:** Dark Brown (131), Black (110). **Cover Color:** Black (110). Venting plug is covered by US Patent D 553,717 S.

Ultra Camtainers®

A contemporary line, featuring two wide nylon latches per unit that are easy to open and close.



CODE	UC250	UC500	UC1000
CAPACITY	2¾ gal.	5¼ gal.	10½ gal.
7 OZ. CUPS	50	96	192
EXTERIOR DIM. W x D x H	11¾" x 16¾" x 19¾"	11¾" x 16¾" x 26¾"	16¼" x 20½" x 25¾"
FITS CAMDOLLY	CD100H, CD1826H, CD300H, CD100HB, CD300HB, CD100	CD100H, CD1826H, CD300H, CD100HB, CD300HB, CD100	CD300H, CD1826H, CD2020H, CD100HB, CD300HB, CD1826MTCHB, CD300, CD2020
LIST PRICE EACH	\$ 298.70	\$ 334.75	\$ 453.20
CAMTAINER COVER	UC250CVR: \$ 130.00	UC500CVR: \$ 130.00	UC1000CVR: \$130.00

Case Pack: 1 Colors: Navy Blue (186), Slate Blue (401), Coffee Beige (157), Dark Brown (131), Brick Red (402), Kentucky Green (519), Black (110), Granite Gray (191), Granite Green (192), Granite Sand (194). **InStock Colors:** Dark Brown (131), Black (110), Granite Gray (191). Venting plug is covered by US Patent D 553,717 S. **Cover Color:** Black (110).

Camserver®

- A front-of-house beverage server for hot or cold beverages that does not require canned heating.
- Double-wall polyethylene shell with thick foam insulation retains temperatures for hours.

Colors: Black (110), Dark Taupe (417), Granite Gray (191).



CSR3
Shown in
Dark Taupe.



CSR5
Shown in Black.
Height is approximately 7"
from counter to spigot.



Convenient top-fill opening for fast replenishment without removing lid.

CODE	OVERALL DIMENSIONS W x D x H	CAPACITY	7 OZ. CUPS	LIST PRICE EA.
CSR3	13¾" x 18¾" x 23½"	3 gal.	54	\$ 520.15
CSR5	13¾" x 18¾" x 28"	5	91	540.75

Case Pack: 1

INSULATED BEVERAGE SERVERS ACCESSORIES

Handwash Accessories

- Convenient and economical way to meet health department hand washing requirements on or off premise.
- Attaches to 2.5-gallon (9.5 L) or 5-gallon (19 L) Camtainers® or Ultra Camtainers®.
- Includes four "Handwash Only" labels and an Easy Serve Dispenser lever.

Handwash Accessory Stacking Colors:
Dark Brown (131), Black (110).

Easy Serve Dispenser Color:
Black (110).

Riser Colors: See optional accessories with Camtainers.

Pail with Bail Color: White (148).

Handwash Accessory is covered by the following U.S. Patents: D 506,634 S, D 506,899 S & D 548,980 S.



Shown with 500LCD Camtainer.



CODE	HWAPR	HWATD
DESCRIPTION	With paper towel roll holder	With multi-fold paper towel dispenser
FITS	250LCD, 500LCD, UC250, UC500	250LCD, 500LCD, UC250, UC500
LIST PRICE EACH	\$ 283.25	\$ 370.80

Optional Handwash Accessories

CODE	DESCRIPTION	LIST PRICE EA.
R500LCD	Riser	\$ 101.95
PWB22	Pail with Bail	28.40
LCDES	Easy serve dispenser	17.55

R500LCD, PWB22, LCDES are NSF listed.

Optional Accessories

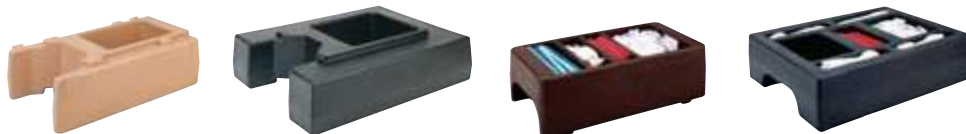

CODE	R500LCD	R1000LCD	LCDCCH	LCDCCH10	LCDES
DESCRIPTION	Riser	Riser	Condiment holder	Condiment holder	Easy serve dispenser
EXTERIOR DIM. W x D x H	9 7/8" x 16 1/4" x 4 9/16"	15 3/8" x 19 1/2" x 4 1/2"	8 3/4" x 16 1/2" x 5"	16" x 20" x 4 13/16"	—
FITS	250LCD, 500LCD, UC250, UC500	1000LCD, UC1000	250LCD, 500LCD, UC250, UC500	1000LCD, UC1000	LCD spigots, UC spigots
LIST PRICE EACH	\$ 101.95	\$ 113.30	\$ 91.65	\$ 133.90	\$ 17.55

Case Pack: 1 Colors: Coffee Beige (157), Dark Brown (131), Black (110). **Easy Serve Dispenser Color:** Black (110).

BEVERAGE SERVICE CARTS



- Ideal for breakfast, coffee or snack service.
- Use top counter to hold Cambro Beverage Servers, Versa Organizer Bins or Display Trays with Covers for food.
- Store drinkware, additional food items or other supplies in open compartment.
- Insulated cabinets hold hot or cold food in 1/1, 1/2 or 1/3 size food pans or on Cambro Metric Camtrays® (3253).

Colors: Slate Blue (401), Granite Gray (191), Granite Green (192).

See Organizer section for more information on Organizer Bins.

See Beverage Server section for more information.

Wire Rack Color: Silver (000).

6" Casters: 2 fixed, 2 swivel, 1 with brake.



MDC24F
Shown in Granite Gray (191).

Beverage Service Cart is designed to hold Beverage Containers at point of service only. A dolly or hand truck with safety strap is recommended for moving Beverage Containers over longer distances or uneven surfaces.

CODE	EXTERIOR DIM. L x W x H	CASE PACK	LIST PRICE EA.
MDC24F	44½" x 30" x 44"	1	\$ 2,652.25
MDC24	44½" x 30" x 44"	1	2,652.25
OPTIONAL ACCESSORIES			
Organizer Bin			
5412CBP	12" x 5" x 4¼"	12	10.25
Camtainer®			
100LCD	10⅞" x 11¾" x 17¼"	1	239.70
Wire Rack			
MDC24R	23" x 17" x 14"	1	194.00
Camchiller®			
CP1220	20 ¹³ / ₁₆ " x 12 ⁷ / ₈ " x 11½"	1	144.20



MDC24, shown in Granite Green (192), has recessed top that holds 3 each 1 gallon Camtainers and stacked Condiment Bins & Wire Rack with 3253 trays.

The use of racks in the MDC24 and MDC24F carts will allow the following configuration of pans or trays, per compartment:

DESCRIPTION	FULL (1/1)	HALF (1/2)	THIRD (1/3)
2½" Pans	(4) 12CW	(8) 22CW	(12) 32CW
4" Pans	(3) 14CW	(6) 24CW	(9) 34CW
6" Pans	(2) 16CW	(4) 26CW	(6) 36CW
8" Pans	(1) 18CW*	(2) 28CW*	(3) 38CW*
Metric Camtrays®	(10) 3253	—	—

*With room for 2½" or 4" pan above 8" pan.

Compartment Dimensions:

Shelf Compartment:	W 37 ¹⁵ / ₁₆ "	D 25 ⁷ / ₈ "	H 10"
Holding Compartments:	W 17 ⁷ / ₁₆ "	D 23 ³ / ₈ "	H 14 ¹ / ₂ "

Venting plug is covered by U.S. Patent D 553,717S.



MDC24R Wire Rack

Wire Rack (sold separately) to organize pans and trays in the cart. Rack holds 1/1, 1/2 and 1/3 size Food Pans and 3253 trays. When placed in cart's holding compartment, the rack allows room on either side for CP1220 Camchillers®.

MERCHANDISING



VERSA FOOD SERVICE SYSTEM



The Versa Food Service System provides custom design without the custom price. This non electric, versatile, portable system keeps food cold for hours with either ColdFest® pans or Buffet Camchillers®. The system is made of durable all-weather material and is easy to clean. The Versa Food Service System offers countless configurations to fit any foodservice need.

- Ergonomic, molded-in handles on both sides ensure easy maneuvering.
- Versa Food Bar and Work Table both include a drain faucet that can be connected to a hose for drainage and easy cleaning.
- Add an end table to a Food Bar or Work Table to hold trays, condiments, or paper goods.

Versa Cart

- Join a Versa Cart with a Food Bar or Work Table for fast check-out and improved traffic flow.
- The Versa Cart includes an adjustable shelf, standard lockable drawer and convenient electrical access through the top of the cart and front design panel.
- Optional tray rails easily adjust to a lower height.
- Optional pull-out keyboard tray fits inside the drawer.



All components are fully compliant with NSF requirements.

Versa Food Service System is covered under U.S. Patent 9,084,498 B2.

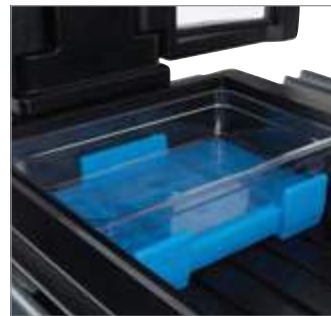

Versa Straight Connector and Versa Corner Connector

Easily and safely attach multiple components together to create a contiguous system and maximize space and merchandising options.

Buffet Camchillers

Extend safe, cold holding time without ice. Dual-sided Buffet Camchillers hold 2½" (6,5 cm) and 4" (10 cm) pans. Fits in the Versa Food Bar, Versa Work Table and Table Top Food Bars.

VERSA FOOD SERVICE SYSTEM

Whether you're looking to maximize space, improve traffic flow, add merchandising space or create an upscale salad bar, the Versa Food Service System has you covered.



All components are fully compliant with NSF requirements.

Versa Food Bar®
As Shown: VBR5 shown with optional 2-VCS32R, 1-VBRTBL.



VBR5



Standard height model.

Versa Work Table

- Perfect for a prep table, display, self-serve station or back bar.
- Attach a Work Table to a Food Bar to merchandise snacks and beverages.
- Matching well covers are included with each Versa Work Table.

VERSA BAR AND VERSA WORK TABLE

- Now available with two secure storage cabinets that can hold up to 50 lbs. (22,7 kg) per compartment of non-perishable items.
- Preferred Salad Bar of Salad Bars to Schools Campaign.



Scan QR code for package product code.



VBRUT5



VBRTBL

VCS32R

VBR6 with optional 2-VBRR6, 2-VBRTBL.

Storage Dimensions:
L 21 1/2" x W 17 1/2" x D 18" per cabinet.
Each cabinet is 3.92 cu. ft. (0,11 M³).



All components are fully compliant with NSF requirements.

VERSA FOOD SERVICE SYSTEM

CODE	DESCRIPTION	OVERALL EXTERIOR DIMENSIONS L x W x H	FULL PAN SIZE CAPACITY	WELL INTERIOR DIMENSIONS L x W x H	LIST PRICE EA.
Versa Food Bars® - Standard Height					
VBR5	5' with standard casters	69" x 42½" x 62¾"	4	52⅝" x 21" x 7⅞"	\$ 3,373.25
VBRU5	5' with standard casters and storage	69" x 42½" x 62¾"	4	52⅝" x 21" x 7⅞"	4,300.25
VBRHD5	5' with heavy duty casters	69" x 42½" x 62¾"	4	52⅝" x 21" x 7⅞"	3,615.30
VBRUHD5	5' with heavy duty casters and storage	69" x 42½" x 62¾"	4	52⅝" x 21" x 7⅞"	4,542.30
VBR6	6' with standard casters	82" x 42½" x 62¾"	5	65⅞" x 21" x 7⅞"	3,512.30
VBRU6	6' with standard casters and storage	82" x 42½" x 62¾"	5	65⅞" x 21" x 7⅞"	4,593.80
VBRHD6	6' with heavy duty casters	82" x 42½" x 62¾"	5	65⅞" x 21" x 7⅞"	3,759.50
VBRUHD6	6' with heavy duty casters and storage	82" x 42½" x 62¾"	5	65⅞" x 21" x 7⅞"	4,841.00
Versa Food Bars - Low Height					
VBRL5	5' with standard casters	69" x 42½" x 55¾"	4	52⅝" x 21" x 7⅞"	3,373.25
VBRLHD5	5' with heavy duty casters	69" x 42½" x 55¾"	4	52⅝" x 21" x 7⅞"	3,615.30
VBRL6	6' with standard casters	82" x 42½" x 55¾"	5	65⅞" x 21" x 7⅞"	3,512.30
VBRLHD6	6' with heavy duty casters	82" x 42½" x 55¾"	5	65⅞" x 21" x 7⅞"	3,759.50
Versa Work Tables - Standard Height					
VBRT5	5' with standard casters	69" x 27" x 36¼"	4	52⅝" x 21" x 7⅞"	2,487.45
VBRUT5	5' with standard casters and storage	69" x 27" x 36¼"	4	52⅝" x 21" x 7⅞"	2,909.75
VBRTHD5	5' with heavy duty casters	69" x 27" x 36¼"	4	52⅝" x 21" x 7⅞"	2,734.65
VBRUTHD5	5' with heavy duty casters and storage	69" x 27" x 36¼"	4	52⅝" x 21" x 7⅞"	3,156.95
VBRT6	6' with standard casters	82" x 27" x 36¼"	5	65⅞" x 21" x 7⅞"	2,631.65
VBRUT6	6' with standard casters and storage	82" x 27" x 36¼"	5	65⅞" x 21" x 7⅞"	3,038.50
VBRTHD6	6' with heavy duty casters	82" x 27" x 36¼"	5	65⅞" x 21" x 7⅞"	2,878.85
VBRUTHD6	6' with heavy duty casters and storage	82" x 27" x 36¼"	5	65⅞" x 21" x 7⅞"	3,285.70
Versa Work Tables - Low Height					
VBRTL5	5' with standard casters	69" x 27" x 29¼"	4	52⅝" x 21" x 7⅞"	2,379.30
VBRTLHD5	5' with heavy duty casters	69" x 27" x 29¼"	4	52⅝" x 21" x 7⅞"	2,626.50
VBRTL6	6' with standard casters	82" x 27" x 29¼"	5	65⅞" x 21" x 7⅞"	2,523.50
VBRTLHD6	6' with heavy duty casters	82" x 27" x 29¼"	5	65⅞" x 21" x 7⅞"	2,770.70

Case Pack: 1

CODE	DESCRIPTION	OVERALL EXTERIOR DIMENSIONS W x D x H	LIST PRICE EA.
Versa Cart			
VCSWR	With dual tray rails and standard casters	52¾" x 32" x 43" (with tray rails up)	\$ 2,611.05
VCSWRHD	With dual tray rails and heavy duty casters	52¾" x 32" x 43¾" (with tray rails up)	3,290.85
VCS	With standard casters and no tray rails	32¼" x 32" x 43"	2,538.95
VCSHD	With heavy duty casters and no tray rails	32¼" x 32" x 43¾"	2,796.45

Connectors

		L x W x H	
VBRC	Straight connector - food bar to food bar	27" x 19" x 4¼"	185.40
VBRC90	Corner connector - food bar to food bar	36" x 36" x 4¼"	319.30
VCS32CNT	Straight connector - cart to standard height food bar / work table	27" x 20⅝" x 3¼"	329.60
VCSCNL	Straight connector - cart to low height food bar / work table	27" x 20⅝" x 8½"	401.70

Case Pack: 1

Versa Food Bar, Versa Work Table, Versa Cart, Connectors, Well Cover Color:

InStock Color



Black

Made to Order Colors for Versa Food Bar, Versa Work Table, Versa Cart, Connectors, Well Cover, Tray Rail and End Table:



Hot Red



Navy Blue



Kentucky Green

Made To Order Items Not Carried In Stock, Non-Returnable.

Tray Rail and End Table Colors Only:

InStock Colors



Granite Gray



**Black

**Made to order color for 1 Tray Rail and 1 End Table. These must be ordered in increments of 2 each. (Minimum of 2 each).

FOOD BAR ACCESSORIES

Every Accessory You Need

- Crock and salad bowl holders highlight and organize salads, condiments and dressings.
- Tray rails offer convenience for your patrons.

See Camwear® Food Pans and Crocks section for more information.

Versa Cart with Dual Tray Rails

(VCSWR & VCSWRHD): All orders receive the tray rails in Granite Gray (191). To choose a different color tray rail you must order the Versa Cart Without Rails (VCS or VCSHD) and the tray rails (VCS32R) separately.

Connector Colors: Black (110), Hot Red (158), Navy Blue (186), Kentucky Green (519).

Vinyl Cover Color: Opaque (000).

Sign Holder Color: Clear (152).

Buffet Camchiller® Color:

Cold Blue (159).

Divider Bar Colors: White (148), Clear (152).

Well Cover Colors: Black (110), Hot Red (158), Navy Blue (186), Kentucky Green (519).

Keyboard Tray Color: Black (110).

Crock, Salad Bowl Holders Colors: White (148), Granite Gray (191).

Versa Food Bar is covered under U.S. Patent D 615,323 S and D 620,730. Versa Food Bar Ultra Series is covered under U.S. Patent D702,066 S. Versa Cart is covered under U.S. Patent D 653,830 S. Buffet Camchiller is covered under U.S. Patent D 618,476 S. All other parts patent pending.

*Items are not NSF Listed.



- 6 ft. models hold 5 full size pans with divider bars.
- 5 ft. models hold 4 full size pans with divider bars.

- Fractional size pans can be used in many variations with divider bars. Mix and match sizes to fit your needs.

Two salad bowl holder models available, SBH18 and SBH15. Crock holder, CPH3, holds 1.5 and 2.7 qt. crocks.

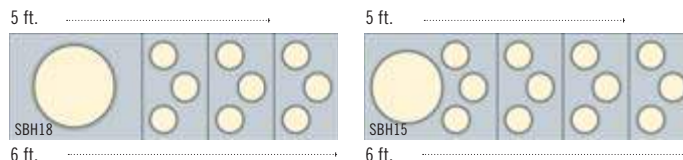

- 6 ft. models hold a salad bowl holder and 3 ea. crock holders.
- 5 ft. models hold a salad bowl holder and 2 ea. crock holders.

CODE	DESCRIPTION	OVERALL EXTERIOR DIMENSIONS	CASE PACK	LIST PRICE EA.
VBRR5	Tray rail for 5' - Versa Food Bar / Work Table	L 53" x W 11½" x H 4⅞"	1	\$ 448.05
VBRR6	Tray rail for 6' - Versa Food Bar / Work Table	L 66" x W 11½" x H 4⅞"	1	478.95
VCS32R	Tray rail for - Versa Cart	L 28" x W 11⅙" x H 5"	1	370.80
VBRTBL	End table for Versa Food Bar and Work Table	L 27" x W 22" x H 4½"	1	484.10
VBRCVR5*	Vinyl cover for 5' Versa Food Bar	L 73" x W 43½" x H 46"	1	310.00
VBRCVR6*	Vinyl cover for 6' Versa Food Bar	L 83" x W 43½" x H 46"	1	340.00
VBRTCVR5*	Vinyl cover for 5' Versa Work Table	L 70" x W 33½" x H 21"	1	165.00
VBRTCVR6*	Vinyl cover for 6' Versa Work Table	L 83" x W 33½" x H 21"	1	180.00
VCSCVR*	Vinyl cover for Versa Cart	L 42" x W 33" x H 36"	1	165.00
VBRSHTS*	Versa Food Bar sign holder	L 36" x W 6" x H 9¼"	1	280.00
DIV12	12" divider bars	L 12¾"	3	4.35
DIV20	20" divider bars	L 20⅞"	3	10.35
CPH3	Crock holder holds 1.5 & 2.7 qt.	L 12⅞" x W 20⅞"	1	75.20
SBH15	Salad bowl holder holds a 15" bowl and 3 crocks	L 25¾" x W 20⅞"	1	75.20
SBH18	Salad bowl holder holds an 18" bowl	L 25¾" x W 20⅞"	1	75.20
CPB1220	Buffet Camchiller for Versa Food Bars, Work Tables and table top food bars	L 18½" x W 12⅝" x H 4"	1	195.70
VBRWC	Versa well cover for Versa Food Bar / Work Table	L 20⅞" x W 13" x H 2"	1	139.05
VCS32KEYT	Versa Cart keyboard tray	L 20⅞" x W 10⅞" x H 2"	1	107.10

Versa Food Bar Well Cover InStock Color: Black (110).

TABLE TOP FOOD BARS, BUFFET BARS & SNEEZE GUARDS



Table Top Food Bars

- Turn a 4'-6' (122-183 cm) table into a double-sided self service buffet or beverage station.

- Thick, foam-insulated well keeps food cold for hours with Buffet Camchillers® or ice.
- Drain plug allows for quick and easy clean-up.



4FBRTT Table Top Food Bar
Buffet Camchiller available.

Buffet Bars

- Ideal for holding snacks and cold beverages.
- The Buffet Bar with Sneeze Guard is perfect for single-sided, self-serve buffets.

BUF48 and BUF72 are NSF listed.

BUF48 and FSG480 can be shipped by parcel carrier.

*NSF listed for non-direct food contact only.



FSG480 Sneeze Guard
The Free Standing Sneeze Guard is the perfect showcase for salad or dessert items.



BUF48 Buffet Bar Base
Merchandises soft drinks on ice to increase beverage sales.



BBR480 Buffet Bar with Sneeze Guard

CODE	OVERALL EXTERIOR DIMENSIONS	FULL SIZE PAN CAPACITY	WELL INTERIOR DIMENSIONS	LIST PRICE EA.
Table Top Food Bars				
	L x W x H		L x W x D	
6FBRTT	71½" x 33¼" x 27"	5	62⅞" x 20⅞" x 6½"	\$ 1,838.55
5FBRTT	63½" x 33¼" x 27"	4	50⅞" x 20⅞" x 6½"	1,704.65
4FBRTT	51" x 33¼" x 27"	3	37¼" x 20⅞" x 6½"	1,545.00
Buffet Bars				
	L x W x H		L x W x D	
BUF72	67½" x 24" x 7"	5	62⅞" x 20⅞" x 5"	525.30
BUF48	41⅓" x 24" x 7"	3	37¼" x 20⅞" x 5"	453.20
Free Standing Sneeze Guards				
	L x W x H		L x W	
FSG720*	73⅞" x 16½" x 24½"	—	67½" x 15¼"	520.15
FSG480*	48" x 16½" x 24½"	—	42" x 15¼"	406.85
Buffet Bars w/Sneeze Guard				
	L x W x H		L x W x D	
BBR720	73⅞" x 24⅞" x 24½"	5	62⅞" x 20⅞" x 5"	1,019.70
BBR480	48" x 24⅞" x 24½"	3	37⅞" x 20⅞" x 5"	860.05

Case Pack: 1 **Made to Order Colors:** Black (110), Navy Blue (186), Kentucky Green (519), Hot Red (158).

CAMKIOSK® SYSTEM – EVERY EVENT OR LOCATION IS AN OPPORTUNITY FOR PROFITS



- Build sales off premise and in non-traditional locations.
- Two insulated food storage cabinets maintain safe hot or cold food and/or beverage temperatures for hours.
- Use optional well covers to cover food pan wells and increase countertop space.
- Durable, all-weather polyethylene exterior with foam insulation will not crack, dent, bubble, chip, rust or break.
- Heavy duty 6" (15,2 cm) casters roll smoothly from kitchen to location then lock in place.

CAMKIOSK® CARTS



Conveniently located, lockable cash box (included) can also be kept in dry storage compartment.



Camchillers® keep packaged foods cold during transport and service. Place directly on top of food pan wells or at the top of the CamKiosk insulated holding cabinet.



4 well top with work space.



6 well top.



Telescoping poles enable canopy to lower 12" for quick and easy storage.



KVC854C Cart with 4 pan wells & canopy.

Cart Colors Canopy Color

186	Navy Blue	157	Beige
158	Hot Red		

Cart Colors Canopy Color

191	Granite Gray	519	Kentucky Green
192	Granite Green		
519	Kentucky Green		
426	Black Base with Granite Gray Top & Doors		

Personalize your CamKiosk Cart to promote your brand.

Canopy Trim and Top Panel

Call 714-230-4125 for a quote.

Front Display Panel

(Cruising Café® panel standard)
Set Up Charge per Panel \$ 135.00
Charge NET per Color 10.00

CODE	FULL SIZE PAN WELLS	OVERALL DIMENSIONS L x W x H	LIST PRICE EA.
CamKiosk Carts			
KVC854	4	85½" x 33½" x 70½"	\$ 7,889.80
KVC854C	4	85½" x 33½" x 94"	10,763.50
KVC856	6	85½" x 33½" x 70½"	7,889.80
KVC856C	6	85½" x 33½" x 94"	10,763.50

C: Canopy

Holding Capacity Per Compartment

Two holding cabinets store hot or cold food in Gastronorm Food Pans with Covers.

12 GN 1/1 full size 2½" deep pans or
8 GN 1/1 full size 4" deep pans or
6 GN 1/1 full size 6" deep pans or
4 GN 1/1 full size 8" deep pans or
4 each 2025 Camtrays® or
8 each 3253 Camtrays.

Well Cover Colors:

Black (110), Hot Red (158), Navy Blue (186), Kentucky Green (519), Granite Gray (191), Granite Green (192).

6" Casters:

2 swivel, 2 swivel with brake.

Cutting Board Color:

White (148).

Camchiller Color:

Cold Blue (159).

ThermoBarrier Color:

Slate Blue (401).



CODE	DESCRIPTION	DIMENSIONS L x W x H	CASE PACK	LIST PRICE EA.
Optional Accessories				
CB1220	Cutting board	21" x 13½" x ½"	1	\$ 43.25
CP814	8" x 14" Camchiller	1½" x 8" x 14"	1	73.00
CP1210	Camchiller GN 1/2	10½" x 12¼" x 1½"	1	75.20
CP1220	Camchiller GN 1/1	20¾" x 12½" x 1½"	1	144.20
WCR1220	Well cover	21" x 13" x 2"	1	108.15
1600DIV	ThermoBarrier® insulated shelf	20½" x 13½" x 1½"	2	91.65

CAMKIOSK® HAND SINK CART, WORK STATION & EQUIPMENT STAND

Hand Sink Cart

- Self-contained, electric hand washing system can be used alone or with CamKiosk Cart.
- Run hot and cold water for up to 70 hand washings.
- Includes: double sink, two 5-gallon (19 L) fresh water tanks, two 7½-gallon (28,5 L) waste-water bins, hand soap dispenser and paper towel roll holder.
- Durable polyethylene will not crack, dent, bubble, chip or break.
- Hand Sink Cart is designed for hand washing. It contains no filter for purifying water for drinking.
- Faucet is compliant with lead-free regulations.

Colors: Granite Gray (191), Granite Green (192), Navy Blue (186), Hot Red (158), Kentucky Green (519), Black Base with Granite Gray Top & Doors (426).

6" Casters: 2 fixed, 2 swivel with brake.

Hand Sink Cart is covered by U.S. Patent 6,173,458 B1.



Water heater and water pump draw a maximum of 11.25 amps and 0.7 amps, respectively. Hand Sink Cart electrical system runs on an average 10 amps.

ADA faucet available. Contact Cambro Customer Service for information.



CODE	VOLTAGE	DIMENSIONS L x W x H	LIST PRICE EA.
KSC402	110	40 ⁹ / ₁₆ " x 33" x 45 ¹ / ₂ "	\$ 5,731.95

Case Pack: 1

Work Station

- Use to merchandise menu items, additional work space or to complete sales transactions.
- Large storage cabinet below is perfect for holding supplies.
- Extremely durable all-weather polyethylene will not crack, dent, bubble, chip, rust or break.

Colors: Granite Gray (191), Granite Green (192), Navy Blue (186), Hot Red (158), Kentucky Green (519), Black Base with Granite Gray Top & Doors (426).

6" Casters: 2 fixed, 2 swivel with brake.

Top work area dimensions: 22½" x 26"



Shown with optional cutting board and paper towel roll dispenser.



CODE	DESCRIPTION	DIMENSIONS L x W x H	LIST PRICE EA.
KWS40	Work station	40 ⁹ / ₁₆ " x 33" x 45 ¹ / ₂ "	\$ 2,750.10
CB1220	Cutting board	21" x 13 ³ / ₈ " x ½"	43.25

Case Pack: 1

Equipment Stand

- Perfect for self-serve stations, prep areas or cash register service.
- Counter and side openings for electrical cords and cables.
- Tray rails fold down for convenient transportation and storage.
- Durable, lightweight polyethylene will not crack, dent, bubble, chip, rust or break.
- No assembly required.

Color: Black (110).

5" Casters: 2 fixed, 2 swivel with brake.

*Special order item not carried in stock, non-returnable.







Cutaway chair area gives ample space for comfortable seating.

CODE	DESCRIPTION	OVERALL DIMENSIONS W (W/TRAY RAILS) x D x H	LIST PRICE EA.
ES28	Stand only	28" x 28" x 39"	\$ 1,395.65
ES28RL*	Stand w/rails on right and left sides of drawer	44" x 28" x 39"	1,859.15

Height includes casters.

CAMCRUISER® VENDING CARTS

- Add revenue opportunities away from the kitchen or cafeteria and reduce wait times.
- Durable polyethylene will not crack, dent, bubble, chip, rust or break.
- Display panel can be personalized with a custom logo or message.
- Larger models CVC724 & CVC72 have insulated food storage compartments and full-size food pan wells.
- Compact model CVC55 has two open storage compartments, a single food pan well, cutting board and umbrella.

Cart Colors	Umbrella Colors
Black (110)	
Hot Red (158)	
Kentucky Green (519)	
Granite Gray (191)	
Granite Green (192)	



CVC724

OPEN COMPARTMENT DIMENSIONS:
W 13³/₈" x D 24¹/₄" x H 13³/₄"
W 33,5 x D 61,5 x H 34 cm

CVC724 & CVC72



CVC724 has four full size food pan wells. Fill with cutting boards or well covers to create additional work space.



CVC72 Has one full size food pan well and two larger merchandising wells.



Open holding compartment conveniently stores cash box and tray.



Place one or two half size Camchillers® directly on top of food pan well to hold cold packaged foods cold.



CVC72

CODE	CVC724	CVC72	CVC55
OVERALL DIMENSION*	L 74¹/₂" x W 31³/₄" x H 94"	L 74¹/₂" x W 31³/₄" x H 94"	L 55⁷/₁₆" x W 31¹/₄" x H 93¹/₂"
WORK COUNTER HEIGHT	36¹/₂"	36¹/₂"	39³/₄"
COUNTER WELLS HOLD	4 full size pans, 6" deep	Center well, 1 full size pan, 6" deep 2 outer wells, L 22¹/₈" x W 15³/₈" x D 6"	1 full size pan, 8" deep
CLOSED COMPARTMENT CAPACITY (EACH)	2 full size 8" + 2 full size 2¹/₂" deep pans or 4 full size 6" deep pans or 6 full size 4" deep pans or 8 full size 2¹/₂" deep pans or 4 each 2025 Camtrays® or 8 each 3253 Camtrays	2 full size 8" + 2 full size 2¹/₂" deep pans or 4 full size 6" deep pans or 6 full size 4" deep pans or 8 full size 2¹/₂" deep pans or 4 each 2025 Camtrays or 8 each 3253 Camtrays	—
OPEN COMPARTMENT CAPACITY	1 cash drawer and 1 full size 6" deep pan or 2 full size 4" deep pans or 3 full size 2¹/₂" deep pans	1 cash drawer and 1 full size 6" deep pan or 2 full size 4" deep pans or 3 full size 2¹/₂" deep pans	—
UMBRELLA DIAMETER	72" (183 cm)	72" (183 cm)	60" (152 cm)
CASTERS	8" – 4 swivel with brake	8" – 4 swivel with brake	6" – 2 fixed, 2 swivel with brake
CASH DRAWER	Yes	Yes	—
MENU BOARD	Yes	Yes	—
DISPLAY PANEL	Yes	Yes	Yes
MOLDED IN HANDLES	2	2	1
LIST PRICE EACH	\$ 6,468.40	\$ 6,468.40	\$ 3,872.80

*Includes Umbrella. Serving counter height is 51".

CAMCRUISER® VENDING CARTS



CVC55

Cutting Board Color: White (148).
Camchiller® Color: Cold Blue (159).
Divider Bar Colors: White (148), Clear (135).
Retainer Strap Color: Black (110).
ThermoBarrier® Color: Dark Brown (131).

ThermoBarrier, Camchillers and Divider Bar are NSF Listed.

Well Cover Color matches cart.

CVC55 is covered by U.S. Patent D 362,102.



LEFT COMPARTMENT DIMENSIONS:
W 24¼" x D 28½" x H 27½"

RIGHT COMPARTMENT DIMENSIONS:
W 21½" x D 28½" x H 27½"

- Compartments are open for storage and easy access to equipment and supplies for your vending operations. Optional retainer strap is sold separately.
- Display panel can be personalized.



Personalize your Camcruiser Cart to promote your brand.

Front Display Panel
"Campus Cuisine" display panel standard on CVC724 & CVC72. Striped panel standard on CVC55.

Set Up Charge per Panel \$ 135.00 (Net)
Charge per Color 10.00 (Net)



Sandwich Camcruiser



Pizza Camcruiser



Hot Dog Camcruiser



Soft Drink Camcruiser

CVC55



Set up with full or fractional size food pans and divider bars to increase product offerings.



Electrical or soda line conveniently drops through 4" x 6¾" opening in counter. Cover is standard with cart.

CODE	DESCRIPTION	FITS	OVERALL DIM. L x W x H	LIST PRICE EA.
Optional Accessories				
CB1220	Cutting board	CVC724, CVC72, CVC55	21" x 13⅞" x ½"	\$ 43.25
1200DIV	ThermoBarrier	CVC724, CVC72	20⅞" x 13⅞" x 1⅞"	91.65
CP1220	1/1 GN Camchiller	CVC724, CVC72	20⅜" x 12⅞" x 1½"	144.20
CP1210	1/2 GN Camchiller	CVC724, CVC72	10⅜" x 12¾" x 1½"	75.20
CP814	Camchiller	CVC72, CVC724	14" x 8" x 1½"	73.00
DIV12	Divider bar	CVC724, CVC72, CVC55	Well only	4.35
WCR1220	Well cover	CVC724, CVC72, CVC55	21" x 13" x 2"	108.15
730STP	Retainer strap	CVC55	—	26.80

DIV12 Case Pack: 3 1200DIV Case Pack: 2 730STP Retainer Strap Case Pack: 2 All Others Case Pack: 1

CAMSHELVING® PREMIUM SERIES FLEX STATION

- Reduce serving time by setting up portable Grab-N-Go stations in convenient locations.
- Ideal for breakfast to go, fresh fruit and vegetable programs, boosting a la carte sales and supper or summer feeding programs.
- Order food pans, boxes and lids separately to hold and display items for quick access.
- Freeze Compact Camchiller® overnight. Place inside full size food pans or food boxes to keep fruits, vegetables and beverages cool and delicious for hours.



Shown with Optional Food Storage Boxes



Flex Station Merchandiser



- Attract more kids and increase participation with colorful graphics.
- Black magnetic frame with matte vinyl finish holds up to 8½" x 11" menu or information at eye level.
- Easy to install and clean.
- Withstands years of use with proper care and handling.



Flex Station

CODE	DESCRIPTION	DIMENSIONS	LIST PRICE EA.
CPMU244867FXPKG	Premium Series Flex Station	D 24" x L 48" x H 67"	\$1,068.90
GSFLEXMERCH	Flex Station Merchandiser	Side Panel: W 23" x H 56" Header Panel: W 48" x H 8"	1,165.00



Units Include: 2 unassembled mobile post kits, 8 traverses, 36 angled divider bars (4 extra) 4 total locking casters and 24 identification tags. Assembly required. Ships in 17 cartons. Height includes casters. **CSFLEXMERCH Case Pack:** 1

Accessories – Combine and Create Custom Flex Station

CODE	DESCRIPTION	DIMENSIONS D x L x H	CASE PACK	LIST PRICE EA.
16CW	Full Size Camwear® Food Pan	12¾" x 20⅞" x 6"	6	\$32.95
24LPCW	Half Size Long Camwear Food Pan	6⅞" x 20⅞" x 4"	6	20.20
12189CW	Half Size Camwear Food Box	12" x 18" x 9"	6	41.00
1218SCCW	Camwear SlidingLid™ for Food Box	12" x 18"	6	31.80
CP814	Compact Camchiller	8" x 14" x 1½"	1	73.00

16CW and 24LPCW Food Pans Colors: Black (110), Clear (135), White (148).
12189CW Food Box and 1218SCCW Sliding Lid Color: Clear (135).
CP814 Color: Cold Blue (159).



Angled Divider Bars

Securely hold food pans and boxes in place allowing easy access.



Camwear Food Storage Box

Shatterproof and durable, clear box allows for content visibility. Ideal for serving bulk fruits and vegetables during the day and keeping them fresh in a cooler or freezer overnight.



Camwear Food Pans

Store, transport, and serve all in one pan. Durable black food pans provide a sleek, modern look and are easy to clean and store when not in use.

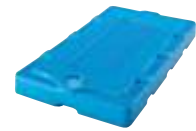

Compact Camchiller

Keep temperature sensitive items cool for hours with Camchillers. Reduce the risk of cross contamination by eliminating the use of ice.

VERSA ORGANIZERS

- Use to store non-perishable condiments, disposable ware and napkins.
- Hold bins in 2 x 3, 2 x 4, 3 x 3, or 3 x 4 arrangements.
- Made of seamless, one-piece polyethylene.
- Set on flat surface or wall mount each bin holds up to 10 lbs. (4,5 kg).
- Easy to assemble and easy to clean.

Bins Only

Colors: Dark Brown (131), Black (110), Slate Blue (401), Speckled Gray (480).

Versa Line Combined Pack Bins & Racks

Colors: Black (110), Speckled Gray (480).



12RS12 Versa Organizer shown mounted on wall.



Bins sold separately (5412CBP) or as combined packs.



12RS12



9RS9



8RS8



6RS6

CODE	DESCRIPTION	PRODUCT DIMENSIONS	CASE PACK	LIST PRICE EA.
Bins				
5412CBP	Bin only	W x D x H 5" x 12" x 4 1/4"	12	\$ 10.25
Versa Line Combined Pack				
12RS12	Rack w/12 bins	L x D x H (complete unit) 25 5/8" x 21 3/8" x 14 1/4"	1	209.10
9RS9	Rack w/9 bins	20 7/8" x 21 3/8" x 14 1/4"	1	184.35
8RS8	Rack w/8 bins	25 5/8" x 17 1/4" x 9 1/4"	1	168.90
6RS6	Rack w/6 bins	20 7/8" x 17 1/4" x 9 1/4"	1	151.40



PORTABLE CAMBARS®

- Stylish, portable beverage bars for hosting in any environment.
- Select from three systems: economy for bottle and can service, partial or complete soda gun set up systems for pre-mix (canisters) or post-mix (bag-in-box).
- Available in three sizes:
 - Large BAR730 is perfect for banquets and cocktail events.
 - Mid-size BAR650 fits into standard elevators and is ideal for small to mid-size functions.
 - Small BAR540 is ultra portable for off-premise use and events with limited space.
- All models include speed rail and 80-pound capacity ice sink with cover. BAR540 sink comes uncovered.
- Impact-resistant, waterproof polyethylene will not crack, dent, bubble, chip, rust or break.
- Lightweight and portable.
- Easy to take apart and clean, easy to set up.





BAR650 Shown in Standard Decor Granite Sand (194).



BAR650DS Shown in Designer Decor Sedona (668).

Three Sizes

Three Systems

	Economy System <ul style="list-style-type: none"> • For Bottle, Can, or Mixer Service • Includes Ice Bin & Speed Rail • Standard or Designer Decor 	Basic System <ul style="list-style-type: none"> • Partially Equipped for Post or Pre-Mix Soda Service • Operator Completes Installation • Standard or Designer Decor 	Complete System <ul style="list-style-type: none"> • Completely Factory Equipped for Post or Pre-Mix Soda Service • Standard or Designer Decor
Large BAR730 Models 	Standard Decor BAR730 Designer Decor BAR730DS	Standard Decor BAR730CP Designer Decor BAR730DSCP	Standard Decor BAR730PM, BAR730PMT, BAR730PMT220, BAR730DX Designer Decor BAR730DSPM, BAR730DSPMT, BAR730DSPMT2, BAR730DSDX
Mid-Size BAR650 Models 	Standard Decor BAR650 Designer Decor BAR650DS	Standard Decor BAR650CP Designer Decor BAR650DSCP	Standard Decor BAR650PM, BAR650PMT, BAR650PMT220, BAR650DX Designer Decor BAR650DSPM, BAR650DSPMT, BAR650DSPMT2, BAR650DSDX
Small BAR540 Models 	Standard Decor BAR540 Designer Decor BAR540DS	N/A	N/A

PORTABLE CAMBAR® PACKAGES & ACCESSORIES

STANDARD EQUIPMENT, SODA GUNS, STANDARD AND DESIGNER DECOR PACKAGES

STANDARD DECOR EQUIPMENT DESIGNER DECOR EQUIPMENT	ECONOMY			BASIC SYSTEM		COMPLETE SYSTEM POST-MIX (Bag in Box)				COMPLETE SYSTEM PRE-MIX (Canisters)	
	BAR540 BAR540DS	BAR650 BAR650DS	BAR730 BAR730DS	BAR650CP BAR650DSCP	BAR730CP BAR730DSCP	BAR650PM BAR650DSPM	BAR650PMT BAR650DSPMT	BAR730PM BAR730DSPM	BAR730PMT BAR730DSPMT	BAR650DX BAR650SDX	BAR730DX BAR730SDX
Bag In Box Syrup Pumps						3	3	6	6		
Bag In Box Rack (Holds 3 Boxes)						1	1	2	2		
Carbonator						YES	YES	YES	YES		
CO ₂ Regulator						YES	YES	YES	YES	YES	YES
CO ₂ Clamp & Chain				YES	YES	YES	YES	YES	YES	YES	YES
8 Circuit Cold Plate in Ice Sink				YES	YES	YES	YES	YES	YES	YES	YES
Ice Sink and Cover	Sink Only	YES	YES	YES	YES	YES	YES	YES	YES	YES	YES
Retainer Strap		1	2	1	2	1	1	2	2	1	2
Soda Gun (6 or 8 buttons)								8	8		6
Speed Rail (5 or 7 bottle)	5	7	7	7	7	7	7	7	7	7	7
Water Pump						YES	YES	YES	YES		
Water Tank							YES		YES		
Water Line Hook Up (city source)						YES	YES	YES	YES		
Waste Water Bin		YES	YES	YES	YES	YES	YES	YES	YES	YES	YES
Vinyl Cover	YES	YES	YES	YES	YES	YES	YES	YES	YES	YES	YES

Casters: All BAR540 Models - Four 5" (12,7 cm) swivel, two with brake. All BAR650 and BAR730 Models - Four 6" (15,24 cm) swivel, two with brake.

Soda Guns by Wunder-Bar®



Post-Mix 8 Button
(BAR730 Complete System)



Pre-Mix 6 Button
(BAR730 Complete System)

- Fast, low foaming delivery.
- Two year warranty from Wunder-Bar®.
- Includes holster with overflow drain.
- Available with complete systems only.

Standard Decor Colors BAR540, BAR650, BAR730



110
Black



191
Granite Gray



194
Granite Sand

BAR650, BAR730 Only

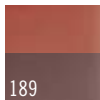

189
Two-Tone Brown
Mahogany



420
Granite Gray w/
Black Base

BAR540 Only



131
Dark Brown

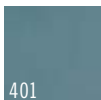

401
Slate Blue

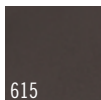

615
Charcoal Gray

Designer Decor BAR650, BAR730 Only



667
Manhattan

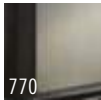

770
Chicago

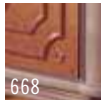

668
Sedona

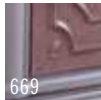

669
Carmel

BAR540 Designer Decor color options are listed with BAR540 details.

Exclusive Cold Plate

- Patented "roof top" design allows for melted ice water to drain into the bottom of the ice sink and into the waste-water bin.
- Circuit exposure through cold plate chills liquids dispensed from the soda gun.



Cold Plate is covered under
U.S. Patent 5,743,602.

Optional Accessories for CamBars

CODE	DESCRIPTION	LIST PRICE EA.
650WS	Wire shelf for BAR650	\$ 68.00
730WS	Wire shelf for BAR730	47.40
730SR	7 bottle speed rail	108.15
BAR54SR	5 bottle speed rail	74.15

Case Pack: 1

730SR Speed Rail Colors: Black (110), Dark Brown (131), Granite Gray (191).

BAR54SR Speed Rail Colors: Black (110), Dark Brown (131), Gray (180), Granite Gray (191), Granite Sand (194), Slate Blue (401).

CAMBAR® POST-MIX SYSTEM FEATURES

Redesigned for Peak Functionality

- Soda gun and GFI-protected 110V outlet are ergonomically positioned for convenient operator access and maximized workspace.
- NSF listed beverage line with Flushable Glas-Flex™ liner for easy flushing and changing of even the strongest flavors.
- Hygienic and easy-to-clean.

Front

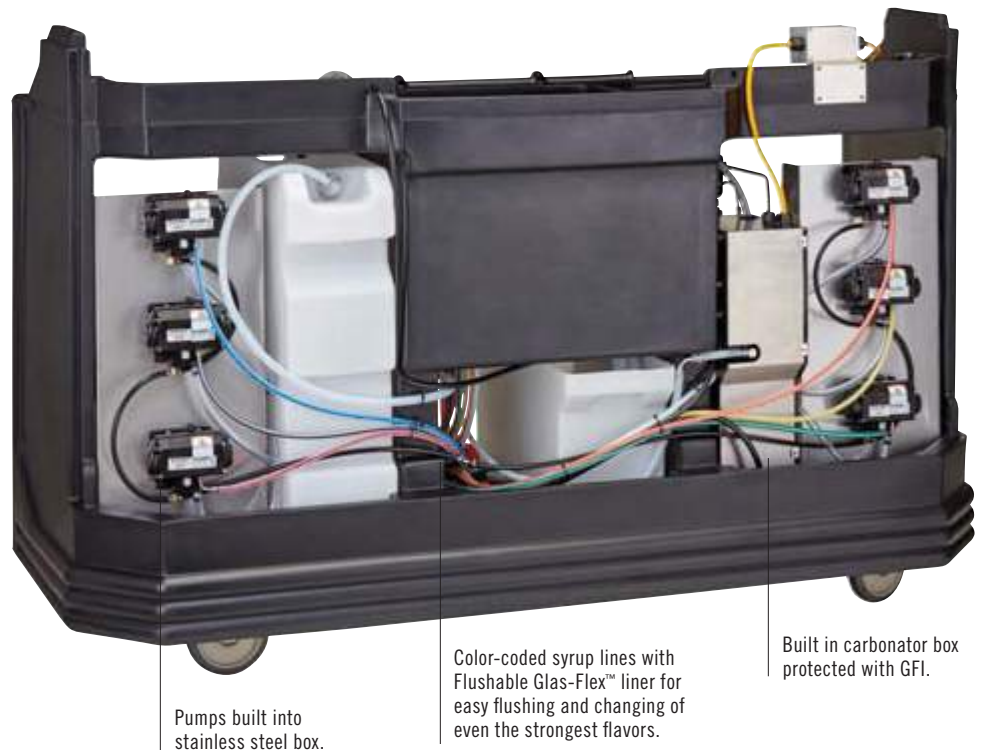

Back

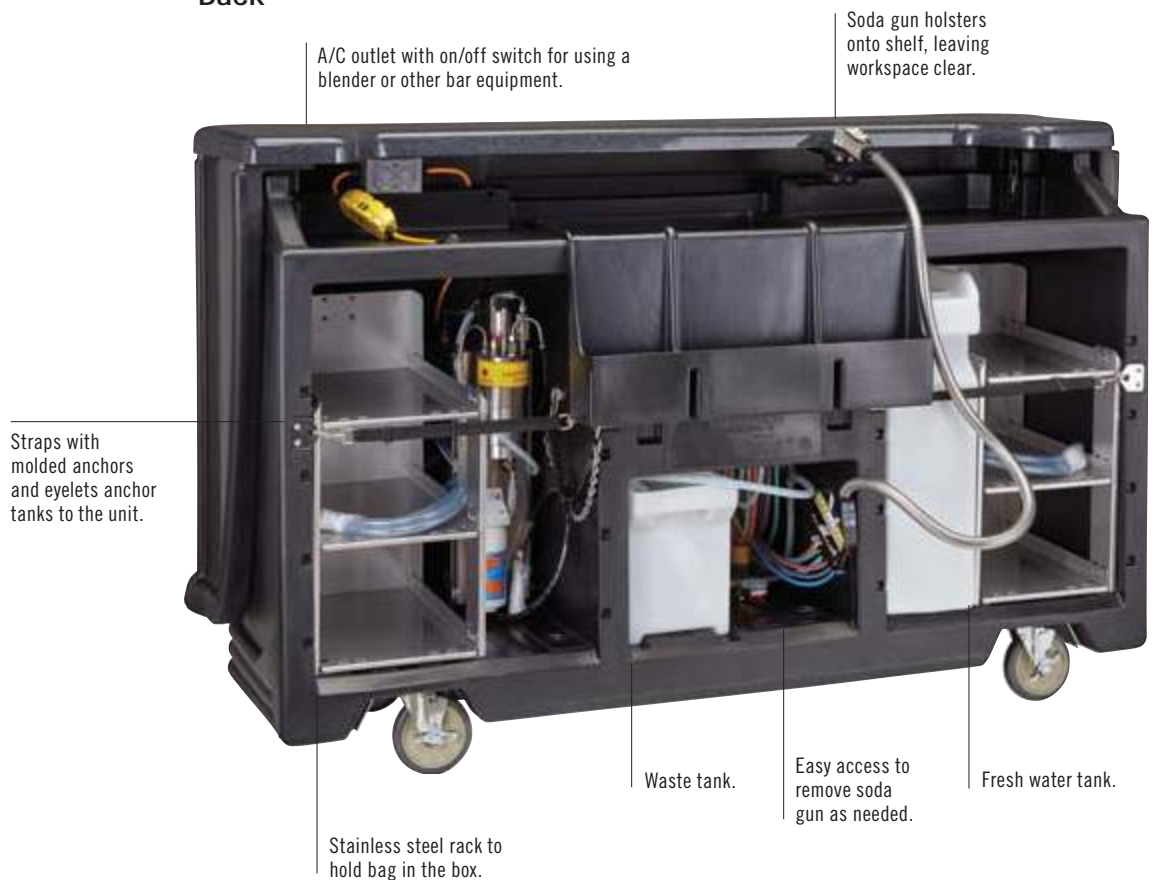

LARGE CAMBARS® – COMPLETE SYSTEMS BAR730

Post-mix System for 5-gallon (18,9 L), Bag-in-box Syrups Holds up to 6 syrup boxes and 1 CO₂ tank.

BAR730PM and BAR730DSPM

Includes the standard equipment from the Basic System plus:

- Post-mix soda gun with 8 buttons
- Carbonator
- 2 stainless steel bag-in-box wire racks
- 6 bag-in-box pumps
- CO₂ regulator gauge & tubing, hose & lines
- Line for city water hook-up

BAR730PMT, BAR730DSPMT, BAR730PMT220 and BAR730DSPMT2

Includes all of the above plus 1, 17-gallon (64,3 L) water tank and 1 water pump. Line for city water hook-up is not included.



BAR730SDSX Shown in Designer Decor Carmel (669).

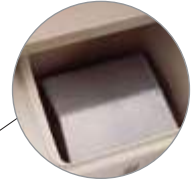

Cold Plate



BAR730DSPMT Shown with water tank and bag-in-box racks.



CODE	VOLTS	WATER TANK	DIMENSIONS L x W x H	UNIT WEIGHT	LIST PRICE EA.
Standard Decor					
BAR730PM	110	No	72¾" x 26" x 48"	335 lbs.	\$ 15,367.60
BAR730PMT	110	Yes	72¾" x 26" x 48"	346	16,799.30
BAR730PMT220	220	Yes	72¾" x 26" x 48"	346	16,922.90
Designer Decor					
BAR730DSPM	110	No	77⅞" x 28½" x 47½"	388	17,345.20
BAR730DSPMT	110	Yes	77⅞" x 28½" x 47½"	398	19,528.80
BAR730DSPMT2	220	Yes	77⅞" x 28½" x 47½"	398	19,652.40



Vinyl cover included with all CamBars. Cover not NSF listed.

Pre-mix System for 5-gallon (18,9 L) Soda Canisters Holds up to 7 canisters and 1 CO₂ tank.

BAR730DX and BAR730SDSX

Includes the standard equipment from the Basic System plus:

- Pre-mix soda gun with 6 buttons

CODE	WATER TANK	DIMENSIONS L x W x H	UNIT WEIGHT	LIST PRICE EA.
Standard Decor				
BAR730DX	No	72¾" x 26" x 48"	293 lbs.	\$ 10,248.50
Designer Decor				
BAR730SDSX	Yes	77⅞" x 28½" x 47½"	332	13,704.15

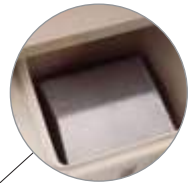

Cold Plate



BAR730DX

LARGE CAMBARS® – ECONOMY AND BASIC SYSTEMS BAR730

Basic System BAR730 Partially Equipped for Soda Service

Requires customer installation of pre-mix or post-mix soda gun system.

Includes:

- Sealed-in cold plate w/8 circuits
- CO₂ chain
- 7-bottle speed rail
- 80-pound (36,3 kg) capacity ice sink
- Ice sink cover
- Waste-water bin
- 2 retainer straps
- 4, 6" (15,2 cm) swivel casters, 2 with brake
- Vinyl cover

CODE	DIMENSIONS L x W x H	UNIT WEIGHT	LIST PRICE EA.
Standard Decor			
BAR730CP	72¾" x 26" x 48"	291 lbs.	\$ 8,852.85
Designer Decor			
BAR730DSCP	77⅝" x 28½" x 47½"	321	12,493.90

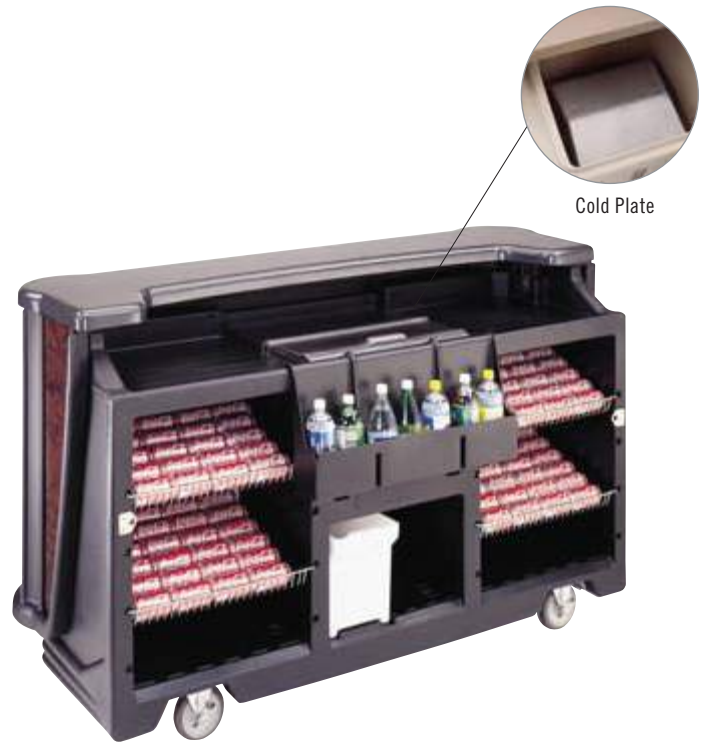

BAR730DSCP
Shown with four optional wire racks; see details under Portable CamBar Packages & Accessories.

Economy System BAR730 For Bottle, Can or Mixer Service

Includes:

- 7-bottle speed rail
- 80-pound (36,3 kg) capacity ice sink
- Ice sink cover
- Waste-water bin
- 2 retainer straps
- 4, 6" (15,2 cm) swivel casters, 2 with brake
- Vinyl cover

CODE	DIMENSIONS L x W x H	UNIT WEIGHT	LIST PRICE EA.
Standard Decor			
BAR730	72¾" x 26" x 48"	198 lbs.	\$ 6,200.60
Designer Decor			
BAR730DS	77⅝" x 28½" x 47½"	245	8,337.85



MID-SIZE CAMBARS® – COMPLETE SYSTEMS BAR650

**Post-mix System for
5-gallon (18,9 L) Bag-in-box Syrups**
Holds up to 3 syrup boxes and 1 CO₂ tank.

BAR650PM and BAR650DSPM

Includes the standard equipment from the Basic System plus:

- Post-mix soda gun
- Carbonator
- Stainless steel bag-in-box wire rack
- 3 bag-in-box pumps
- CO₂ regulator gauge & tubing, hose & lines
- Line for city water hook-up
- Water pump
- Water filter

BAR650PMT, BAR650DSPMT, BAR650PMT220 and BAR650DSPMT2

Includes all of the above plus 1, 17-gallon (64,3 L) water tank and 1 water pump. Line for city water hook-up is not included.

CODE	VOLTS	WATER TANK	DIMENSIONS L x W x H	UNIT WEIGHT	LIST PRICE EA.
Standard Decor					
BAR650PM	110	No	67½" x 28½" x 47½"	301 lbs.	\$ 14,291.25
BAR650PMT	110	Yes	67½" x 28½" x 47½"	312	15,661.15
BAR650PMT220	220	Yes	67½" x 28½" x 47½"	312	16,129.80
Designer Decor					
BAR650DSPM	110	No	67½" x 28½" x 47½"	348	15,764.15
BAR650DSPMT	110	Yes	67½" x 28½" x 47½"	359	17,767.50
BAR650DSPMT2	220	Yes	67½" x 28½" x 47½"	359	17,885.95



Cold Plate



BAR650DSPMT
Shown with water tank and bag-in-box rack.

Pre-mix System for 5-gallon (18,9 L) Soda Canisters
Holds up to 5 canisters and 1 CO₂ tank.

BAR650DX and BAR650SDSX

Includes the standard equipment from the Basic System plus:

- Pre-mix soda gun

CODE	DIMENSIONS L x W x H	UNIT WEIGHT	LIST PRICE EA.
Standard Decor			
BAR650DX	67½" x 28½" x 47½"	265 lbs.	\$ 9,584.15
Designer Decor			
BAR650SDSX	67½" x 28½" x 47½"	312	11,577.20



Cold Plate



BAR650SDSX

MID SIZE AND SMALL CAMBARS® – ECONOMY AND BASIC SYSTEMS

Basic System BAR650 – Mid-Size Model Partially Equipped for Soda Service

Requires customer installation of pre-mix or post-mix soda gun system.

- Includes:**
- Sealed-in cold plate with 8 circuits
 - CO₂ chain
 - 7-bottle speed rail
 - 80-pound (36,3 kg) capacity ice sink
 - Ice sink cover
 - Waste-water bin
 - Retainer strap
 - 4, 6" (15,2 cm) swivel casters, 2 with brake
 - Vinyl cover

CODE	DIMENSIONS L x W x H	UNIT WEIGHT	LIST PRICE EA.
Standard Decor			
BAR650CP	67½" x 28½" x 47½"	285 lbs.	\$ 7,797.10
Designer Decor			
BAR650DSCP	67½" x 28½" x 47½"	303	10,063.10



Cold Plate

BAR650DSCP
Shown with two optional wire racks; see details under Portable CamBar Packages & Accessories.

Economy System BAR650 – Mid-Size Model For Bottle, Can or Mixer Service

- Includes:**
- 7-bottle speed rail
 - 80-pound (36,3 kg) capacity ice sink
 - Ice sink cover
 - Waste-water bin
 - Retainer strap
 - 4, 6" (15,2 cm) swivel casters, 2 with brake
 - Vinyl cover

CODE	DIMENSIONS L x W x H	UNIT WEIGHT	LIST PRICE EA.
Standard Decor			
BAR650	67½" x 28½" x 47½"	173 lbs.	\$ 5,294.20
Designer Decor			
BAR650DS	67½" x 28½" x 47½"	220	7,143.05



BAR650DS
Shown with two optional wire racks; see details under Portable CamBar Packages & Accessories.

Economy System BAR540 – Small Model For Bottle, Can, or Mixer Service

- Includes:**
- 5-bottle speed rail
 - 80-pound (36,3 kg) capacity ice sink
 - 4, 5" (12,7 cm) swivel casters, 2 with brake
 - Vinyl cover

CODE	DIMENSIONS L x W x H	UNIT WEIGHT	LIST PRICE EA.
Standard Decor			
BAR540	54" x 25½" x 46½"	117 lbs.	\$ 2,714.05
Designer Decor			
BAR540DS	54" x 25½" x 46½"	123	3,445.35



BAR540DS

Designer Decor Colors

BAR540 Only

670 Black Base w/ Coal Counter

671 Granite Gray Base w/ Slate Gray Counter

672 Granite Sand Base w/ Cocoa Counter

SLIDINGLID™ ICE CADDIES



- Polyethylene body and thick foam insulation hold ice for days.
- Rugged, all-weather exterior will not crack, dent, bubble, chip, rust or break.
- Unique sliding lid slides back and under during use, reducing risk of cross-contamination.
- Recessed well and drain shelf keep ice out of water, extending holding times.
- Recessed, molded-in handles ease lifting and maneuvering.
- Slant top sliding lid units fit under prep/catering tables and counters.



ICS175LB
(Short) Shown with Rear Easy Wheels.



ICS125L
(Short)



ICS100L
(Short)



ICS175T
(Tall)



ICS175TB
(Tall) Shown with Rear Easy Wheels.



ICS200TB
(Tall) Shown with Rear Wide Easy Wheels.



BAR650DS shown in Designer Decor Sedona (668) with ICS175TB shown in Granite Gray (191).

Colors: Black (110), Slate Blue (401), Dark Brown (131), Coffee Beige (157), Granite Gray (191).

Personalization available. Special quote only. Contact customer service.

SlidingLid Ice Caddies ICS125L and ICS125LB are covered by US Patent D 468,071 S. SlidingLid Ice Caddies ICS100L and S are covered by US Patent D 424,883.



Caster Descriptions

Refers to caster type in chart.
All casters are 5" (12,7 cm).

A: 2 fixed, 2 swivel, 1 with brake

A1: 2 swivel, 2 with brakes

B: 4 swivel, 1 with brake

C: 2 swivel, 1 with brake,
2, 8" Easy Wheels

D: 2 swivel, 1 with brake,
2, 10" Easy Wheels

E: 2 swivel, 1 with brake,
2, 10" Wide Easy Wheels



CODE	HOLDING CAPACITY LBS.	EXTERIOR DIMENSIONS W x D x H	CASTER TYPE	LIST PRICE EA.
Short				
ICS100L	100	22½" x 30¼" x 28¾"	A1	\$ 1,071.20
ICS100L4S	100	22½" x 30¼" x 28¾"	B	1,102.10
ICS125L	125	23" x 31½" x 29¼"	A	1,096.95
ICS125LB	125	23" x 31½" x 29¼"	C	1,174.20
ICS175L	175	24" x 37½" x 29¼"	A	1,302.95
ICS175LB	175	24" x 37½" x 29¼"	D	1,359.60
Tall				
ICS125T	125	23" x 31½" x 34½"	A	1,163.90
ICS175T	175	23" x 34" x 37½"	A	1,369.90
ICS175TB	175	23" x 34" x 37½"	D	1,457.45
ICS200TB	200	23" x 34" x 39½"	E	1,493.50

Case Pack: 1 **InStock Colors:** Black (110), Dark Brown (131).

WAREWASHING



CAMRACK® 4-IN-1 WAREWASHING SYSTEM

The Camrack System will protect glassware and keep it clean until the next event, eliminating the need for rewashing.

Camrack Cover Seals from the Top and Camdolly® Seals from the Bottom.

Efficient Washing

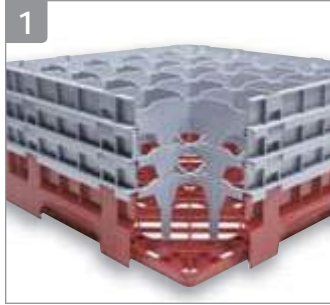

Open inside compartments provide thorough circulation of water and cleaning solutions and promote quick and thorough drying.

Long-lasting polypropylene Camracks are built to withstand chemicals and high temperatures up to 200°F (93°C).

Sanitary Storage



Closed outer walls keep fingers and contaminants out and reduce risk of breakage and injury. The Camrack Cover and Camdolly make this system completely enclosed. Glassware stays clean in storage, eliminating rewashing.

Inventory Control



A variety of base rack colors help identify at a glance both contents and quantity per rack. Available in 10 colors.

Safe, Sanitary Transportation



Camracks can be transported across large campuses or to off-site locations in one single unit.

Easy to grip handles and smooth overlapping sides facilitate safe handling.



Camracks interstack with racks from major manufacturers.



Content labeling options include one-color custom hot stamping or pre-printed clips.



Camracks are covered by one or more of the following patents: Full Base Dish Rack D 412,607. Half Base Dish Rack D 404,176. Half Dish Rack Extender D 400,321. Enlarged Dish Rack Extender D 399,614. Dish Rack with Extender 5,934,486 Utility Patent. Pronged Base Dish Rack D 403,472.

FULL SIZE CAMRACKS® FOR STEMWARE & TUMBLERS

These racks offer complete protection for all your delicate and valuable stemware and tumblers, from washing and handling to stacking, storing and transporting.

Choose the correct dishrack:

1. Measure the maximum diameter of your glass (stemware or tumbler) to determine the number of compartments.
2. Measure the maximum height of your glass (stemware or tumbler) to the top edge of the rim to determine the compartment height.

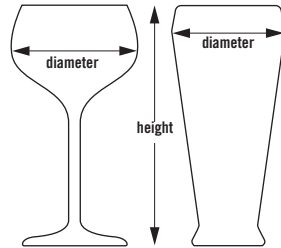

25S534

5 7/8" 5.875" (14,9 cm)
MAXIMUM DIAMETER

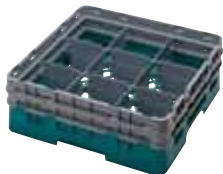

9 COMPARTMENT

	3 5/8" 3.625" (9,2 cm)	5 1/4" 5.25" (13,3 cm)	6 7/8" 6.875" (17,4 cm)	8 1/2" 8.5" (21,5 cm)	10 1/8" 10.125" (25,7 cm)	11 3/4" 11.75" (29,8 cm)
MAXIMUM HEIGHT						
CODE	9S318	9S434	9S638	9S800	9S958	9S1114
CASE PACK	5	4	3	2	2	2
RACK DIMENSION	19 3/4" x 19 3/4" x 5 5/8" 50 x 50 x 14,3 cm	19 3/4" x 19 3/4" x 7 1/4" 50 x 50 x 18,4 cm	19 3/4" x 19 3/4" x 8 3/8" 50 x 50 x 22,5 cm	19 3/4" x 19 3/4" x 10 1/2" 50 x 50 x 26,7 cm	19 3/4" x 19 3/4" x 12 5/8" 50 x 50 x 30,8 cm	19 3/4" x 19 3/4" x 13 3/4" 50 x 50 x 34,9 cm
LIST PRICE EACH	\$ 58.60	\$ 76.45	\$ 91.20	\$ 110.95	\$ 128.60	\$ 149.75

4 3/8" 4.375" (11,11 cm)
MAXIMUM DIAMETER



16 COMPARTMENT

	3 5/8" 3.625" (9,2 cm)	4 1/2" 4.5" (11,4 cm)	5 1/4" 5.25" (13,3 cm)	6 1/8" 6.125" (15,5 cm)	6 7/8" 6.875" (17,4 cm)	7 3/4" 7.75" (19,6 cm)
MAXIMUM HEIGHT						
CODE	16S318	16S418**	16S434	16S534**	16S638	16S738**
CASE PACK	5	5	4	4	3	3
RACK DIMENSION	19 3/4" x 19 3/4" x 5 5/8" 50 x 50 x 14,3 cm	19 3/4" x 19 3/4" x 5 5/8" 50 x 50 x 14,3 cm	19 3/4" x 19 3/4" x 7 1/4" 50 x 50 x 18,4 cm	19 3/4" x 19 3/4" x 7 1/4" 50 x 50 x 18,4 cm	19 3/4" x 19 3/4" x 8 3/8" 50 x 50 x 22,5 cm	19 3/4" x 19 3/4" x 8 3/8" 50 x 50 x 22,5 cm
LIST PRICE EACH	\$ 58.60	\$ 61.40	\$ 76.80	\$ 78.65	\$ 92.20	\$ 94.10
	8 1/2" 8.5" (21,5 cm)	9 3/8" 9.375" (23,8 cm)	10 1/8" 10.125" (25,7 cm)	11" 11" (27,9 cm)	11 3/4" 11.75" (29,8 cm)	12 5/8" 12.625" (32 cm)
MAXIMUM HEIGHT						
CODE	16S800	16S900**	16S958	16S1058**	16S1114	16S1214**
CASE PACK	2	2	2	2	2	2
RACK DIMENSION	19 3/4" x 19 3/4" x 10 1/2" 50 x 50 x 26,7 cm	19 3/4" x 19 3/4" x 10 1/2" 50 x 50 x 26,7 cm	19 3/4" x 19 3/4" x 12 5/8" 50 x 50 x 30,8 cm	19 3/4" x 19 3/4" x 12 5/8" 50 x 50 x 30,8 cm	19 3/4" x 19 3/4" x 13 3/4" 50 x 50 x 34,9 cm	19 3/4" x 19 3/4" x 13 3/4" 50 x 50 x 34,9 cm
LIST PRICE EACH	\$ 111.30	\$ 113.30	\$ 128.60	\$ 130.60	\$ 149.75	\$ 151.55

Base Rack Colors:

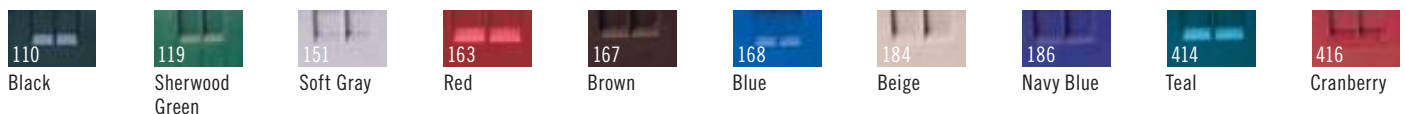

Extender Color: Soft Gray (151). **Compartment Extenders cannot be added. Personalization available. See Camrack personalization and color coding page. Contact Customer Service for all special orders.

FULL SIZE CAMRACKS® FOR STEMWARE & TUMBLERS

3⁷/₈" 3.875" (9,84 cm)
MAXIMUM DIAMETER



20 COMPARTMENT

MAXIMUM HEIGHT	3 ⁵ / ₈ " 3.625" (9,2 cm)	5 ¹ / ₄ " 5.25" (13,3 cm)	6 ⁷ / ₈ " 6.875" (17,4 cm)	8 ¹ / ₂ " 8.5" (21,5 cm)	10 ¹ / ₈ " 10.125" (25,7 cm)	11 ³ / ₄ " 11.75" (29,8 cm)
CODE	20S318	20S434	20S638	20S800	20S958	20S1114
CASE PACK	5	4	3	2	2	2
RACK DIMENSION	19 ³ / ₄ " x 19 ³ / ₄ " x 5 ⁵ / ₈ " 50 x 50 x 14,3 cm	19 ³ / ₄ " x 19 ³ / ₄ " x 7 ¹ / ₄ " 50 x 50 x 18,4 cm	19 ³ / ₄ " x 19 ³ / ₄ " x 8 ⁷ / ₈ " 50 x 50 x 22,5 cm	19 ³ / ₄ " x 19 ³ / ₄ " x 10 ¹ / ₂ " 50 x 50 x 26,7 cm	19 ³ / ₄ " x 19 ³ / ₄ " x 12 ¹ / ₈ " 50 x 50 x 30,8 cm	19 ³ / ₄ " x 19 ³ / ₄ " x 13 ³ / ₄ " 50 x 50 x 34,9 cm
LIST PRICE EACH	\$ 58.60	\$ 77.75	\$ 93.00	\$ 111.30	\$ 128.60	\$ 149.75

3⁷/₁₆" 3.44" (8,7 cm)
MAXIMUM DIAMETER



25 COMPARTMENT

MAXIMUM HEIGHT	3 ⁵ / ₈ " 3.625" (9,2 cm)	4 ¹ / ₂ " 4.5" (11,4 cm)	5 ¹ / ₄ " 5.25" (13,3 cm)	6 ¹ / ₈ " 6.125" (15,5 cm)	6 ⁷ / ₈ " 6.875" (17,4 cm)	7 ³ / ₄ " 7.75" (19,6 cm)
CODE	25S318	25S418**	25S434	25S534**	25S638	25S738**
CASE PACK	5	5	4	4	3	3
RACK DIMENSION	19 ³ / ₄ " x 19 ³ / ₄ " x 5 ⁵ / ₈ " 50 x 50 x 14,3 cm	19 ³ / ₄ " x 19 ³ / ₄ " x 5 ⁵ / ₈ " 50 x 50 x 14,3 cm	19 ³ / ₄ " x 19 ³ / ₄ " x 7 ¹ / ₄ " 50 x 50 x 18,4 cm	19 ³ / ₄ " x 19 ³ / ₄ " x 7 ¹ / ₄ " 50 x 50 x 18,4 cm	19 ³ / ₄ " x 19 ³ / ₄ " x 8 ⁷ / ₈ " 50 x 50 x 22,5 cm	19 ³ / ₄ " x 19 ³ / ₄ " x 8 ⁷ / ₈ " 50 x 50 x 22,5 cm
LIST PRICE EACH	\$ 58.60	\$ 63.40	\$ 77.75	\$ 81.60	\$ 93.00	\$ 100.65
MAXIMUM HEIGHT	8 ¹ / ₂ " 8.5" (21,5 cm)	9 ³ / ₈ " 9.375" (23,8 cm)	10 ¹ / ₈ " 10.125" (25,7 cm)	11" 11" (27,9 cm)	11 ³ / ₄ " 11.75" (29,8 cm)	12 ⁵ / ₈ " 12.625" (32 cm)
CODE	25S800	25S900**	25S958	25S1058**	25S1114	25S1214**
CASE PACK	2	2	2	2	2	2
RACK DIMENSION	19 ³ / ₄ " x 19 ³ / ₄ " x 10 ¹ / ₂ " 50 x 50 x 26,7 cm	19 ³ / ₄ " x 19 ³ / ₄ " x 10 ¹ / ₂ " 50 x 50 x 26,7 cm	19 ³ / ₄ " x 19 ³ / ₄ " x 12 ¹ / ₈ " 50 x 50 x 30,8 cm	19 ³ / ₄ " x 19 ³ / ₄ " x 12 ¹ / ₈ " 50 x 50 x 30,8 cm	19 ³ / ₄ " x 19 ³ / ₄ " x 13 ³ / ₄ " 50 x 50 x 34,9 cm	19 ³ / ₄ " x 19 ³ / ₄ " x 13 ³ / ₄ " 50 x 50 x 34,9 cm
LIST PRICE EACH	\$ 111.30	\$ 120.90	\$ 128.60	\$ 140.10	\$ 149.75	\$ 161.15

**Compartment Extenders cannot be added.

3¹/₈" 3.125" (7,94 cm)
MAXIMUM DIAMETER



30 COMPARTMENT

MAXIMUM HEIGHT	3 ⁵ / ₈ " 3.625" (9,2 cm)	5 ¹ / ₄ " 5.25" (13,3 cm)	6 ⁷ / ₈ " 6.875" (17,4 cm)	8 ¹ / ₂ " 8.5" (21,5 cm)	10 ¹ / ₈ " 10.125" (25,7 cm)	11 ³ / ₄ " 11.75" (29,8 cm)
CODE	30S318	30S434	30S638	30S800	30S958	30S1114
CASE PACK	5	4	3	2	2	2
RACK DIMENSION	19 ³ / ₄ " x 19 ³ / ₄ " x 5 ⁵ / ₈ " 50 x 50 x 14,3 cm	19 ³ / ₄ " x 19 ³ / ₄ " x 7 ¹ / ₄ " 50 x 50 x 18,4 cm	19 ³ / ₄ " x 19 ³ / ₄ " x 8 ⁷ / ₈ " 50 x 50 x 22,5 cm	19 ³ / ₄ " x 19 ³ / ₄ " x 10 ¹ / ₂ " 50 x 50 x 26,7 cm	19 ³ / ₄ " x 19 ³ / ₄ " x 12 ¹ / ₈ " 50 x 50 x 30,8 cm	19 ³ / ₄ " x 19 ³ / ₄ " x 13 ³ / ₄ " 50 x 50 x 34,9 cm
LIST PRICE EACH	\$ 61.40	\$ 78.65	\$ 94.85	\$ 113.30	\$ 132.45	\$ 149.75

FULL SIZE CAMRACKS® FOR STEMWARE & TUMBLERS

36 COMPARTMENT

2⁷/₈" 2.875" (7,3 cm)
MAXIMUM DIAMETER



MAXIMUM HEIGHT	3 ⁵ / ₈ " 3.625" (9,2 cm)	4 ¹ / ₂ " 4.5" (11,4 cm)	5 ¹ / ₄ " 5.25" (13,3 cm)	6 ¹ / ₈ " 6.125" (15,5 cm)	6 ⁷ / ₈ " 6.875" (17,4 cm)	7 ³ / ₄ " 7.75" (19,6 cm)
CODE	36S318	36S418**	36S434	36S534**	36S638	36S738**
CASE PACK	5	5	4	4	3	3
RACK DIMENSION	19 ³ / ₄ " x 19 ³ / ₄ " x 5 ⁵ / ₈ " 50 x 50 x 14,3 cm	19 ³ / ₄ " x 19 ³ / ₄ " x 5 ⁵ / ₈ " 50 x 50 x 14,3 cm	19 ³ / ₄ " x 19 ³ / ₄ " x 7 ¹ / ₄ " 50 x 50 x 18,4 cm	19 ³ / ₄ " x 19 ³ / ₄ " x 7 ¹ / ₄ " 50 x 50 x 18,4 cm	19 ³ / ₄ " x 19 ³ / ₄ " x 8 ⁷ / ₈ " 50 x 50 x 22,5 cm	19 ³ / ₄ " x 19 ³ / ₄ " x 8 ⁷ / ₈ " 50 x 50 x 22,5 cm
LIST PRICE EACH	\$ 61.40	\$ 66.20	\$ 78.65	\$ 85.40	\$ 94.85	\$ 105.45
MAXIMUM HEIGHT	8 ¹ / ₂ " 8.5" (21,5 cm)	9 ³ / ₈ " 9.375" (23,8 cm)	10 ¹ / ₈ " 10.125" (25,7 cm)	11" 11" (27,9 cm)	11 ³ / ₄ " 11.75" (29,8 cm)	12 ⁵ / ₈ " 12.625" (32 cm)
CODE	36S800	36S900**	36S958	36S1058**	36S1114	36S1214**
CASE PACK	2	2	2	2	2	2
RACK DIMENSION	19 ³ / ₄ " x 19 ³ / ₄ " x 10 ¹ / ₂ " 50 x 50 x 26,7 cm	19 ³ / ₄ " x 19 ³ / ₄ " x 10 ¹ / ₂ " 50 x 50 x 26,7 cm	19 ³ / ₄ " x 19 ³ / ₄ " x 12 ⁵ / ₈ " 50 x 50 x 30,8 cm	19 ³ / ₄ " x 19 ³ / ₄ " x 12 ⁵ / ₈ " 50 x 50 x 30,8 cm	19 ³ / ₄ " x 19 ³ / ₄ " x 13 ³ / ₄ " 50 x 50 x 34,9 cm	19 ³ / ₄ " x 19 ³ / ₄ " x 13 ³ / ₄ " 50 x 50 x 34,9 cm
LIST PRICE EACH	\$ 113.30	\$ 125.75	\$ 132.45	\$ 144.90	\$ 149.75	\$ 164.25

**Compartment Extenders cannot be added.

49 COMPARTMENT

2⁷/₁₆" 2.44" (6,2 cm)
MAXIMUM DIAMETER



MAXIMUM HEIGHT	3 ⁵ / ₈ " 3.625" (9,2 cm)	5 ¹ / ₄ " 5.25" (13,3 cm)	6 ⁷ / ₈ " 6.875" (17,4 cm)	8 ¹ / ₂ " 8.5" (21,5 cm)	10 ¹ / ₈ " 10.125" (25,7 cm)	11 ³ / ₄ " 11.75" (29,8 cm)
CODE	49S318	49S434	49S638	49S800	49S958	49S1114
CASE PACK	5	4	3	2	2	2
RACK DIMENSION	19 ³ / ₄ " x 19 ³ / ₄ " x 5 ⁵ / ₈ " 50 x 50 x 14,3 cm	19 ³ / ₄ " x 19 ³ / ₄ " x 7 ¹ / ₄ " 50 x 50 x 18,4 cm	19 ³ / ₄ " x 19 ³ / ₄ " x 8 ⁷ / ₈ " 50 x 50 x 22,5 cm	19 ³ / ₄ " x 19 ³ / ₄ " x 10 ¹ / ₂ " 50 x 50 x 26,7 cm	19 ³ / ₄ " x 19 ³ / ₄ " x 12 ⁵ / ₈ " 50 x 50 x 30,8 cm	19 ³ / ₄ " x 19 ³ / ₄ " x 13 ³ / ₄ " 50 x 50 x 34,9 cm
LIST PRICE EACH	\$ 62.35	\$ 80.55	\$ 96.90	\$ 113.30	\$ 134.35	\$ 155.50



Base Rack Colors:



110
Black



119
Sherwood
Green



151
Soft Gray



163
Red



167
Brown



168
Blue



184
Beige



186
Navy Blue



414
Teal



416
Cranberry

Extender Color: Soft Gray (151). **Compartment Extenders cannot be added.

Personalization available. See Camrack personalization and color coding page. Contact Customer Service for all special orders.



HALF SIZE CAMRACKS® FOR STEMWARE & TUMBLERS

- Very effective for carrying less weight and for storing drinkware in space-restricted locations.
- Ideal for small under-counter glasswashers.

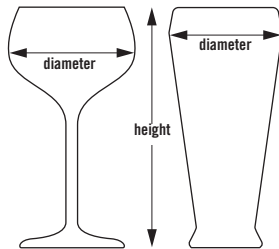

10HS434

8 COMPARTMENT

4¹/₁₆" 4.06" (10,3 cm)
MAXIMUM DIAMETER



	3 ⁵ / ₈ " 3.625" (9,2 cm)	5 ¹ / ₄ " 5.25" (13,3 cm)	6 ⁷ / ₈ " 6.875" (17,4 cm)	8 ¹ / ₂ " 8.5" (21,5 cm)	10 ¹ / ₈ " 10.125" (25,7 cm)	11 ³ / ₄ " 11.75" (29,8 cm)
MAXIMUM HEIGHT						
CODE	8HS318	8HS434	8HS638	8HS800	8HS958	8HS1114
CASE PACK	5	4	3	2	2	2
RACK DIMENSION	19 ³ / ₄ " x 10" x 5 ⁵ / ₈ " 50 x 25 x 14,3 cm	19 ³ / ₄ " x 10" x 7 ¹ / ₄ " 50 x 25 x 18,4 cm	19 ³ / ₄ " x 10" x 8 ⁷ / ₈ " 50 x 25 x 22,5 cm	19 ³ / ₄ " x 10" x 10 ¹ / ₂ " 50 x 25 x 26,7 cm	19 ³ / ₄ " x 10" x 12 ¹ / ₈ " 50 x 25 x 30,8 cm	19 ³ / ₄ " x 10" x 13 ³ / ₄ " 50 x 25 x 34,9 cm
LIST PRICE EACH	\$ 44.20	\$ 60.40	\$ 72.90	\$ 88.20	\$ 103.65	\$ 118.90

10 COMPARTMENT

3⁷/₁₆" 3.44" (8,7 cm)
MAXIMUM DIAMETER



	3 ⁵ / ₈ " 3.625" (9,2 cm)	5 ¹ / ₄ " 5.25" (13,3 cm)	6 ⁷ / ₈ " 6.875" (17,4 cm)	8 ¹ / ₂ " 8.5" (21,5 cm)	10 ¹ / ₈ " 10.125" (25,7 cm)	11 ³ / ₄ " 11.75" (29,8 cm)
MAXIMUM HEIGHT						
CODE	10HS318	10HS434	10HS638	10HS800	10HS958	10HS1114
CASE PACK	5	4	3	2	2	2
RACK DIMENSION	19 ³ / ₄ " x 10" x 5 ⁵ / ₈ " 50 x 25 x 14,3 cm	19 ³ / ₄ " x 10" x 7 ¹ / ₄ " 50 x 25 x 18,4 cm	19 ³ / ₄ " x 10" x 8 ⁷ / ₈ " 50 x 25 x 22,5 cm	19 ³ / ₄ " x 10" x 10 ¹ / ₂ " 50 x 25 x 26,7 cm	19 ³ / ₄ " x 10" x 12 ¹ / ₈ " 50 x 25 x 30,8 cm	19 ³ / ₄ " x 10" x 13 ³ / ₄ " 50 x 25 x 34,9 cm
LIST PRICE EACH	\$ 44.20	\$ 60.40	\$ 72.90	\$ 88.20	\$ 103.65	\$ 118.90

17 COMPARTMENT

2¹/₈" 2.875" (7,3 cm)
MAXIMUM DIAMETER



	3 ⁵ / ₈ " 3.625" (9,2 cm)	5 ¹ / ₄ " 5.25" (13,3 cm)	6 ⁷ / ₈ " 6.875" (17,4 cm)	8 ¹ / ₂ " 8.5" (21,5 cm)	10 ¹ / ₈ " 10.125" (25,7 cm)	11 ³ / ₄ " 11.75" (29,8 cm)
MAXIMUM HEIGHT						
CODE	17HS318	17HS434	17HS638	17HS800	17HS958	17HS1114
CASE PACK	5	4	3	2	2	2
RACK DIMENSION	19 ³ / ₄ " x 10" x 5 ⁵ / ₈ " 50 x 25 x 14,3 cm	19 ³ / ₄ " x 10" x 7 ¹ / ₄ " 50 x 25 x 18,4 cm	19 ³ / ₄ " x 10" x 8 ⁷ / ₈ " 50 x 25 x 22,5 cm	19 ³ / ₄ " x 10" x 10 ¹ / ₂ " 50 x 25 x 26,7 cm	19 ³ / ₄ " x 10" x 12 ¹ / ₈ " 50 x 25 x 30,8 cm	19 ³ / ₄ " x 10" x 13 ³ / ₄ " 50 x 25 x 34,9 cm
LIST PRICE EACH	\$ 46.05	\$ 62.90	\$ 79.30	\$ 96.10	\$ 112.60	\$ 128.60

Base Rack Colors:



119
Sherwood Green



151
Soft Grey

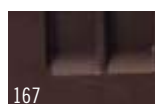

167
Brown



184
Beige

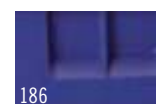

186
Navy Blue



416
Cranberry

Extender Color: Soft Gray (151). Personalization available. See Camrack personalization and color coding page. Contact Customer Service for all special orders.

CAMRACK® FULL & HALF SIZE CUP RACKS

Camrack Cup Racks

Tilt feature drains water from mug or cup bases for quick and sanitary drying.

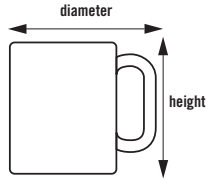

16C414

Full Size

4³/₈" X 4⁵/₁₆"
11,1 x 10,95 cm
COMPARTMENT
DIMENSIONS



16 COMPARTMENT

	2 ⁵ / ₈ " 2.625" (6,6 cm)	4 ¹ / ₄ " 4.25" (10,7 cm)	5 ⁷ / ₈ " 5.875" (14,9 cm)
MAXIMUM HEIGHT			
CODE	16C258	16C414	16C578
CASE PACK	6	5	4
RACK DIMENSION	19 ³ / ₄ " x 19 ³ / ₄ " x 4" 50 x 50 x 10,1 cm	19 ³ / ₄ " x 19 ³ / ₄ " x 5 ⁷ / ₈ " 50 x 50 x 14,3 cm	19 ³ / ₄ " x 19 ³ / ₄ " x 7 ¹ / ₄ " 50 x 50 x 18,4 cm
LIST PRICE EACH	\$ 41.65	\$ 58.05	\$ 86.80

4³/₈" X 3⁷/₁₆"
11,1 x 8,73 cm
COMPARTMENT
DIMENSIONS



20 COMPARTMENT

	2 ⁵ / ₈ " 2.625" (6,6 cm)	4 ¹ / ₄ " 4.25" (10,7 cm)
MAXIMUM HEIGHT		
CODE	20C258	20C414
CASE PACK	6	5
RACK DIMENSION	19 ³ / ₄ " x 19 ³ / ₄ " x 4" 50 x 50 x 10,1 cm	19 ³ / ₄ " x 19 ³ / ₄ " x 5 ⁷ / ₈ " 50 x 50 x 14,3 cm
LIST PRICE EACH	\$ 43.20	\$ 59.45



Half Size

4¹/₈" X 4³/₈"
10,4 x 11,1 cm
COMPARTMENT
DIMENSIONS



8 COMPARTMENT

	2 ⁵ / ₈ " 2.625" (6,6 cm)	4 ¹ / ₄ " 4.25" (10,7 cm)
MAXIMUM HEIGHT		
CODE	8HC258	8HC414
CASE PACK	6	5
RACK DIMENSION	19 ³ / ₄ " x 9 ⁷ / ₈ " x 4" 50 x 25 x 10,1 cm	19 ³ / ₄ " x 9 ⁷ / ₈ " x 5 ⁷ / ₈ " 50 x 25 x 14,3 cm
LIST PRICE EACH	\$ 29.70	\$ 49.35

4¹/₈" X 3⁷/₁₆"
10,4 x 8,73 cm
COMPARTMENT
DIMENSIONS



10 COMPARTMENT

	2 ⁵ / ₈ " 2.625" (6,6 cm)	4 ¹ / ₄ " 4.25" (10,7 cm)
MAXIMUM HEIGHT		
CODE	10HC258	10HC414
CASE PACK	6	5
RACK DIMENSION	19 ³ / ₄ " x 9 ⁷ / ₈ " x 4" 50 x 25 x 10,1 cm	19 ³ / ₄ " x 9 ⁷ / ₈ " x 5 ⁷ / ₈ " 50 x 25 x 14,3 cm
LIST PRICE EACH	\$ 29.70	\$ 49.35

Glass and Cup Keepers

- Raised ribs for easy draining and drying.
- Holds 20 glasses or 12 cups per layer.

Color: Beige (133).



Max. Glass Inside Rim Diameter:
GK2000: 2⁵/₈" (6,6 cm)



Max. Cup Inside Rim Diameter:
KK1200: 2¹⁵/₁₆" (7,4 cm)

Base Cup Rack Color: Soft Gray (151). Extender Color: Soft Gray (151).
Personalization available. See Camrack personalization and color coding page.
Contact Customer Service for all special orders.

CODE	SIZE	LIST PRICE EA.
Glass Keepers		
GK2000	14" x 18"	\$ 17.90
Cup Keepers		
KK1200	13 ¹⁵ / ₁₆ " x 17 ⁷ / ₈ "	16.85
Case Pack: 12		

CAMRACK® ACCESSORIES

Camrack Cover & Camdolly®

- Use to cover and protect full size Camrack dishracks filled with clean dishware.
- When used with a Camdolly, creates a portable sanitary storage system that protects contents between uses.

- Eliminates the use of messy, wasteful plastic wrap or vinyl covers.



FULL RACK COVER	
CODE	DRC2020
EXTERIOR DIMENSIONS	19 ³ / ₈ " x 19 ³ / ₈ " x 1 ⁵ / ₁₆ " (50 x 50 x 2,4 cm)
LIST PRICE EACH	\$ 57.20

Case Pack: 1 Color: Gray (180).

	CAMDOLLY	CAMDOLLY WITH HANDLE
CODE	CDR2020	CDR2020H
INTERIOR DIMENSIONS	20 ⁷ / ₈ " x 20 ⁷ / ₈ " (53 x 53 cm)	20 ⁷ / ₈ " x 20 ⁷ / ₈ " (53 x 53 cm)
EXTERIOR DIMENSIONS	21 ³ / ₈ " x 21 ³ / ₈ " x 8" (54,5 x 54,5 x 20,5 cm)	21 ³ / ₈ " x 23 ³ / ₈ " x 37" (54,5 x 59,5 x 94 cm)
LOAD CAPACITY	350 lbs. (159 kg)	350 lbs. (159 kg)
LIST PRICE EACH	\$ 180.25	\$ 288.40

Case Pack: 1 Casters: 3¹/₂" (10 cm) casters, 4 swivel, no brakes.
Color: Soft Gray (151).

Camrack IceExpress Glass Filler

- Dramatically reduces banquet set-up time.
- Fills 25 glasses with ice all at once.
- Reduces breakage and risk of contamination.
- Ice falls directly into glasses with no spills or drips.

CODE	EXTERIOR DIM. W x D x H	LIST PRICE EA.
25SWGf	20" x 20 ⁷ / ₈ " x 1 ¹ / ₄ " (50,8 x 50,8 x 3,18 cm)	\$ 90.90

Case Pack: 1 Color: Black (110).



Selecting The Right Camrack

Cambro offers multiple ways to help you quickly find the right Camrack:

1. apps.cambro.com/Camracks

Select the item you are sizing, enter the measurements and quantity of the item, and the right Camrack will appear on the page.

2. Cambro Catalog

Flip to the back of the catalog for a convenient stemware, glass and cup sizing reference guide.

3. Cambro Sales Representatives

Contact your local Cambro representative or call Cambro Customer Service at 1 800 833 3003 to assist with specifying Camracks, dollies and covers that will fit your glasses and dishware.

4. Cambro App

Find the right Camrack for your glassware by entering the height and maximum diameter of your glass.

Choose the correct Camrack:

1. Measure the **maximum diameter** of the glass (stemware or tumbler) to determine the number of compartments.
2. Measure the **maximum height** of the glass (stemware or tumbler) to the top edge of the rim to determine the compartment height.

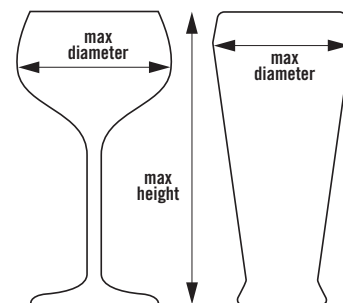

Download the app at
www.cambro.com/app or



CAMRACK® BASE RACKS

- For pots, pans, bowls and large prep, service and display items.
- Half racks work well for storing items at a wait station.



BR578

Full Size Base Racks

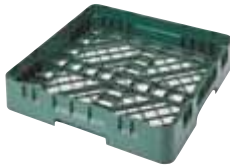

FULL BASE RACK

WITH 1 EXTENDER

WITH 2 EXTENDERS

WITH 3 EXTENDERS

CODE	BR258	BR414	BR578	BR712
INSIDE RACK HEIGHT	3¼" (8,3 cm)	4⅞" (12,4 cm)	6½" (16,5 cm)	8⅞" (20,6 cm)
OUTSIDE RACK HEIGHT	4" (10,1 cm)	5⅞" (14,3 cm)	7¼" (18,4 cm)	8⅞" (22,5 cm)
CASE PACK	6	5	4	3
RACK DIMENSION	19¼" x 19¼" x 4" 50 x 50 x 10,1 cm	19¼" x 19¼" x 5⅞" 50 x 50 x 14,3 cm	19¼" x 19¼" x 7¼" 50 x 50 x 18,4 cm	19¼" x 19¼" x 8⅞" 50 x 50 x 22,5 cm
LIST PRICE EACH	\$ 38.25	\$ 55.70	\$ 71.40	\$ 87.65

Half Size Base Racks



HALF BASE RACK

WITH 1 EXTENDER

WITH 2 EXTENDERS

WITH 3 EXTENDERS

CODE	HBR258	HBR414	HBR578	HBR712
INSIDE RACK HEIGHT	3¼" (8,3 cm)	4⅞" (12,4 cm)	6½" (16,5 cm)	8⅞" (20,6 cm)
OUTSIDE RACK HEIGHT	4" (10,1 cm)	5⅞" (14,3 cm)	7¼" (18,4 cm)	8⅞" (22,5 cm)
CASE PACK	6	5	4	3
RACK DIMENSION	19¼" x 9⅞" x 4" 50 x 25 x 10,1 cm	19¼" x 9⅞" x 5⅞" 50 x 25 x 14,3 cm	19¼" x 9⅞" x 7¼" 50 x 25 x 18,4 cm	19¼" x 9⅞" x 8⅞" 50 x 25 x 22,5 cm
LIST PRICE EACH	\$ 25.90	\$ 41.70	\$ 53.75	\$ 66.20

Full Size Hold Down Grid

Keeps lightweight smallwares in place during wash cycle. Use on full size Camrack Base or Flatware rack.



BR414 with CRPHDG2878

HOLD DOWN GRID

CODE	CRPHDG2878
LIST PRICE EACH	\$ 27.95
Case Pack: 6	Color: Gray (000).

Base Rack Colors:

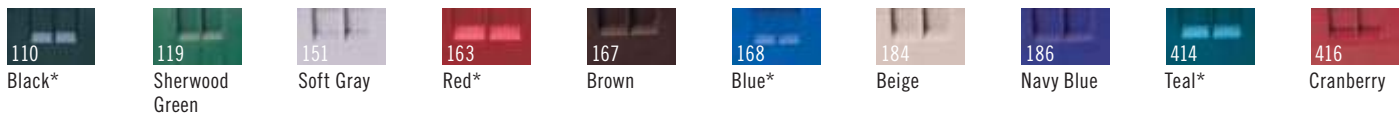

*Full size only. Extender Color: Soft Gray (151). Personalization available. See Camrack personalization and color coding page. Contact Customer Service for all special orders.

CAMRACK® FULL SIZE PEG RACKS & TRAY RACK

Standard 9 x 9 Peg Rack

- Designed to wash varying sized plates, bowls, trays and plate covers.
- Standard peg racks hold:
 - Eighteen 10" (25,4 cm) plates
 - Twelve 12" (30,5 cm) plates
 - Twenty-seven 7½" (19 cm) plates
 or
 - Nine 14" x 18" (36 x 46 cm) trays.

Versatile 5 x 9 Peg Rack

- Holds standard plates in one direction or deep plates, bowls and plate covers in the other direction.
- 5 spacing configuration holds up to ten 10" (25,4 cm) bowls, deep plates, platters or plate covers.

- 9 spacing configuration holds up to:
 - Eighteen 10" (25,4 cm) plates
 - Twelve 12" (30,5 cm) plates
 - Twenty-seven 7½" (19 cm) plates
 or
 - Nine 14" x 18" (36 x 46 cm) trays.

Open End Tray Rack

- Holds cafeteria trays or full-size sheet pans.
- Open-ended on one side for easy placement and removal of trays of all lengths.
- Holds up to nine trays upright.



9 X 9 PEG RACK

9 X 9 PEG RACK WITH 1 EXTENDER

5 X 9 PEG RACK

5 X 9 PEG RACK WITH 1 EXTENDER

OPEN END TRAY RACK

CODE	PR314	PR500	PR59314	PR59500	OETR314*
INSIDE RACK HEIGHT	3¼" (8,3 cm)	4⅞" (12,4 cm)	3¼" (8,3 cm)	4⅞" (12,4 cm)	3¼" (8,3 cm)
OUTSIDE RACK HEIGHT	4" (10,1 cm)	5⅝" (14,3 cm)	4" (10,1 cm)	5⅝" (14,3 cm)	4" (10,1 cm)
CASE PACK	6	5	6	5	6
LIST PRICE EACH	\$ 41.25	\$ 58.60	\$ 41.25	\$ 58.60	\$ 40.40

Color: Soft Gray (151). **Extender Color:** Soft Gray (151). Personalization available. See Camrack personalization and color coding page. Contact Customer Service for all special orders. *Extenders may be added to all Peg Racks except the OETR314.

CAMRACK FULL & HALF SIZE FLATWARE RACKS & CYLINDERS

Camrack Flatware Racks

- 8 Compartment Basket fits into a Full or Half Size Base Rack. Wire handles slide down for easy storage.

- Flatware Cylinder fits into 9-compartment Full Size Camrack and the Cambro Tray and Dish Cart, model TDCR12.



FULL FLATWARE RACK

HALF FLATWARE RACK

8 COMPARTMENT HALF FLATWARE BASKET

8 COMPARTMENT HALF FLATWARE BASKET

FLATWARE CYLINDER

CODE	FR258	HFR258	8FB434* with handles	8FBNH434* no handles	FWC56
INSIDE RACK HEIGHT	2⅝" (6,7 cm)	2⅝" (6,7 cm)	4¾" (12 cm)	4¾" (12 cm)	4½" wide (11,4 cm)
OUTSIDE RACK HEIGHT	4" (10,1 cm)	4" (10,1 cm)	7¼" (18,4 cm)	7¼" (18,4 cm)	5½" high (13,9 cm)
CASE PACK	6	6	6	6	12
LIST PRICE EACH	\$ 41.25	\$ 35.60	\$ 49.00	\$ 28.75	\$ 4.80

Color: Soft Gray (151). **Extender Color:** Soft Gray (151). **Flatware Cylinder Color:** White (148).

Personalization available. See Camrack personalization and color coding page. Contact Customer Service for all special orders. *Extenders cannot be added.

CAMRACK® COMPONENT SYSTEM

The Camrack System offers several choices for ordering the right Camracks. Please consult with your sales representative or Cambro Customer Service for all special ordering and assembly directions.

Choose Between:

1. A complete selection of pre-assembled, ready to use Camracks listed in our catalog; or
2. Custom built special order Camracks for specific needs; or
3. Individual Camrack components for distributors to stock and build racks as needed.

Base Rack Colors:

Sherwood Green (119), Soft Gray (151), Brown (167), Beige (184), Navy Blue (186), Cranberry (416), Black (110)*, Red (163)*, Blue (168)*, Teal (414)*.

Base Cup Rack Color: Soft Gray (151).

Flatware Rack Color: Soft Gray (151).

Extender Color: Soft Gray (151).

.....
*Full size only.
.....

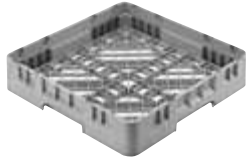

BR = Full Size Base Rack



HBR = Half Size Base Rack



E1 = Full Size Full Drop Compartment Extender



HE1 = Half Size Full Drop Compartment Extender



E2 = Full Size Half Drop Compartment Extender



HE2 = Half Size Half Drop Compartment Extender

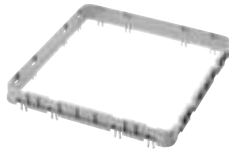

E3 = Full Size Open Extender

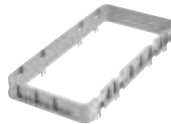

HE3 = Half Size Open Extender

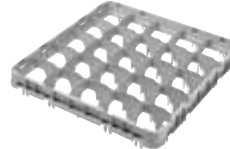

E4 = Full Size Full Drop Compartment Extender

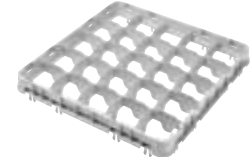

E5 = Full Size Half Drop Compartment Extender

CAMRACK COMPONENTS

Only E3 extenders may be added to E4's and E5's.

CODE	DESCRIPTION	OVERALL DIMENSIONS	COMPARTMENT	INSIDE RACK HEIGHT	CASE PACK	LIST PRICE EA.
Full Size Base Racks						
BR258	Full base rack	19 ³ / ₄ " x 19 ³ / ₄ " x 4" (500 x 500 x 101 mm)	18" x 18" (457 x 457 mm)	2 ⁵ / ₈ " (67 mm)	6	\$ 38.25
Half Size Base Racks						
HBR258	Half base rack	19 ³ / ₄ " x 9 ⁷ / ₈ " x 4" (500 x 250 x 101)	18 ¹ / ₄ " x 8 ³ / ₈ " (464 x 213)	2 ⁵ / ₈ " (67)	6	25.90
Full Size Base Cup Racks						
16C258	16-compartment full cup rack	19 ³ / ₄ " x 19 ³ / ₄ " x 4" (500 x 500 x 101)	4 ³ / ₈ " x 4 ³ / ₈ " (111 x 111)	2 ⁵ / ₈ " (67)	6	41.65
20C258	20-compartment full cup rack	19 ³ / ₄ " x 19 ³ / ₄ " x 4" (500 x 500 x 101)	4 ³ / ₈ " x 3 ¹ / ₂ " (111 x 89)	2 ⁵ / ₈ " (67)	6	43.20
Half Size Base Cup Racks						
8HC258	8-compartment half cup rack	19 ³ / ₄ " x 9 ⁷ / ₈ " x 4" (500 x 250 x 101)	4 ⁷ / ₈ " x 4 ¹ / ₁₆ " (105 x 113)	2 ⁵ / ₈ " (67)	6	29.70
10HC258	10-compartment half cup rack	19 ³ / ₄ " x 9 ⁷ / ₈ " x 4" (500 x 250 x 101)	4 ⁷ / ₈ " x 3 ¹ / ₂ " (105 x 89)	2 ⁵ / ₈ " (67)	6	29.70
Full Size Full Drop Extenders – E1 and GE1						
9E1	9-compartment full drop extender	19 ⁵ / ₈ " x 19 ⁵ / ₈ " x 2" (499 x 499 x 51)	5 ⁷ / ₈ " x 5 ⁷ / ₈ " (150 x 150)	1 ⁵ / ₈ " (41)	12	17.60
16E1	16-compartment full drop extender	19 ⁵ / ₈ " x 19 ⁵ / ₈ " x 2" (499 x 499 x 51)	4 ³ / ₈ " x 4 ³ / ₈ " (111 x 111)	1 ⁵ / ₈ " (41)	12	18.70
20GE1	20-compartment full drop extender	19 ⁵ / ₈ " x 19 ⁵ / ₈ " x 2" (499 x 499 x 51)	3 ⁷ / ₈ " x 3 ⁷ / ₈ " (98 x 98)	1 ⁵ / ₈ " (41)	12	19.70
25E1	25-compartment full drop extender	19 ⁵ / ₈ " x 19 ⁵ / ₈ " x 2" (499 x 499 x 51)	3 ¹ / ₂ " x 3 ¹ / ₂ " (89 x 89)	1 ⁵ / ₈ " (41)	12	19.70
30GE1	30-compartment full drop extender	19 ⁵ / ₈ " x 19 ⁵ / ₈ " x 2" (499 x 499 x 51)	3 ³ / ₈ " x 3 ³ / ₈ " (79 x 79)	1 ⁵ / ₈ " (41)	12	20.05
36E1	36-compartment full drop extender	19 ⁵ / ₈ " x 19 ⁵ / ₈ " x 2" (499 x 499 x 51)	2 ⁷ / ₈ " x 2 ⁷ / ₈ " (73 x 73)	1 ⁵ / ₈ " (41)	12	20.05
49E1	49-compartment full drop extender	19 ⁵ / ₈ " x 19 ⁵ / ₈ " x 2" (499 x 499 x 51)	2 ⁷ / ₁₆ " x 2 ⁷ / ₁₆ " (62 x 62)	1 ⁵ / ₈ " (41)	12	20.05
Full Size Half Drop Extenders – E2 and GE2						
9E2	9-compartment half drop extender	19 ⁵ / ₈ " x 19 ⁵ / ₈ " x 2" (499 x 499 x 51)	5 ⁷ / ₈ " x 5 ⁷ / ₈ " (150 x 150)	1 ⁵ / ₈ " (41)	12	16.60
16E2	16-compartment half drop extender	19 ⁵ / ₈ " x 19 ⁵ / ₈ " x 2" (499 x 499 x 51)	4 ³ / ₈ " x 4 ³ / ₈ " (111 x 111)	1 ⁵ / ₈ " (41)	12	16.60
20E2	20-compartment half drop extender (for cups only)	19 ⁵ / ₈ " x 19 ⁵ / ₈ " x 2" (499 x 499 x 51)	4 ³ / ₈ " x 3 ¹ / ₂ " (111 x 89)	1 ⁵ / ₈ " (41)	12	15.35
20GE2	20-compartment half drop extender	19 ⁵ / ₈ " x 19 ⁵ / ₈ " x 2" (499 x 499 x 51)	3 ⁷ / ₈ " x 3 ⁷ / ₈ " (98 x 98)	1 ⁵ / ₈ " (41)	12	17.10
25E2	25-compartment half drop extender	19 ⁵ / ₈ " x 19 ⁵ / ₈ " x 2" (499 x 499 x 51)	3 ¹ / ₂ " x 3 ¹ / ₂ " (89 x 89)	1 ⁵ / ₈ " (41)	12	17.10
30GE2	30-compartment half drop extender	19 ⁵ / ₈ " x 19 ⁵ / ₈ " x 2" (499 x 499 x 51)	3 ³ / ₈ " x 3 ³ / ₈ " (79 x 79)	1 ⁵ / ₈ " (41)	12	18.05

CAMRACK® COMPONENT SYSTEM

CODE	DESCRIPTION	OVERALL DIMENSIONS	COMPARTMENT	INSIDE RACK HEIGHT	CASE PACK	LIST PRICE EA.
Full Size Half Drop Extenders – E2 and GE2 (continued)						
36E2	36-compartment half drop extender	19 ⁵ / ₈ " x 19 ⁵ / ₈ " x 2" (499 x 499 x 51 mm)	2 ⁷ / ₁₆ " x 2 ⁷ / ₁₆ " (73 x 73 mm)	1 ⁵ / ₈ " (41 mm)	12	\$ 18.05
49E2	49-compartment half drop extender	19 ⁵ / ₈ " x 19 ⁵ / ₈ " x 2" (499 x 499 x 51)	2 ⁷ / ₁₆ " x 2 ⁷ / ₁₆ " (62 x 62)	1 ⁵ / ₈ " (41)	12	18.05
Full Size Open Extender – E3						
E3	Open extender	19 ⁵ / ₈ " x 19 ⁵ / ₈ " x 2" (499 x 499 x 51)	18" x 18" (457 x 457)	1 ⁵ / ₈ " (41)	12	14.15
Full Size Full Drop Extender – E4						
16E4	16-compartment full drop extender	19 ⁵ / ₈ " x 19 ⁵ / ₈ " x 2" (499 x 499 x 51)	4 ³ / ₈ " x 4 ³ / ₈ " (111 x 111)	1 ⁵ / ₈ " (41)	12	20.05
25E4	25-compartment full drop extender	19 ⁵ / ₈ " x 19 ⁵ / ₈ " x 2" (499 x 499 x 51)	3 ¹ / ₂ " x 3 ¹ / ₂ " (89 x 89)	1 ⁵ / ₈ " (41)	12	22.90
36E4	36-compartment full drop extender	19 ⁵ / ₈ " x 19 ⁵ / ₈ " x 2" (499 x 499 x 51)	2 ⁷ / ₁₆ " x 2 ⁷ / ₁₆ " (73 x 73)	1 ⁵ / ₈ " (41)	12	25.90
Full Size Half Drop Extender – E5						
16E5	16-compartment half drop extender	19 ⁵ / ₈ " x 19 ⁵ / ₈ " x 2" (499 x 499 x 51)	4 ³ / ₈ " x 4 ³ / ₈ " (111 x 111)	1 ⁵ / ₈ " (41)	12	17.65
25E5	25-compartment half drop extender	19 ⁵ / ₈ " x 19 ⁵ / ₈ " x 2" (499 x 499 x 51)	3 ¹ / ₂ " x 3 ¹ / ₂ " (89 x 89)	1 ⁵ / ₈ " (41)	12	19.20
36E5	36-compartment half drop extender	19 ⁵ / ₈ " x 19 ⁵ / ₈ " x 2" (499 x 499 x 51)	2 ⁷ / ₁₆ " x 2 ⁷ / ₁₆ " (73 x 73)	1 ⁵ / ₈ " (41)	12	20.05
Half Size Full Drop Extenders – HE1						
8HE1	8-compartment full drop extender	19 ³ / ₄ " x 9 ⁷ / ₈ " x 2" (502 x 252 x 51)	4 ¹ / ₈ " x 4 ¹ / ₁₆ " (105 x 113)	1 ⁵ / ₈ " (41)	12	15.70
10HE1	10-compartment full drop extender	19 ³ / ₄ " x 9 ⁷ / ₈ " x 2" (502 x 252 x 51)	4 ¹ / ₈ " x 3 ¹ / ₂ " (105 x 89)	1 ⁵ / ₈ " (41)	12	15.70
17HE1	17-compartment full drop extender	19 ³ / ₄ " x 9 ⁷ / ₈ " x 2" (502 x 252 x 51)	∅ 2 ¹⁵ / ₁₆ " (∅ 74)	1 ⁵ / ₈ " (41)	12	16.35
Half Size Half Drop Extenders – HE2						
8HE2	8-compartment half drop extender	19 ³ / ₄ " x 9 ⁷ / ₈ " x 2" (502 x 252 x 51)	4 ¹ / ₈ " x 4 ¹ / ₁₆ " (105 x 113)	1 ⁵ / ₈ " (41)	12	14.10
10HE2	10-compartment half drop extender	19 ³ / ₄ " x 9 ⁷ / ₈ " x 2" (502 x 252 x 51)	4 ¹ / ₈ " x 3 ¹ / ₂ " (105 x 89)	1 ⁵ / ₈ " (41)	12	14.75
17HE2	17-compartment half drop extender	19 ³ / ₄ " x 9 ⁷ / ₈ " x 2" (502 x 252 x 51)	∅ 2 ¹⁵ / ₁₆ " (∅ 74)	1 ⁵ / ₈ " (41)	12	15.70
Half Size Open Extenders – HE3						
HE3	Open extender	19 ³ / ₄ " x 9 ⁷ / ₈ " x 2" (502 x 252 x 51)	18 ³ / ₄ " x 8 ³ / ₈ " (464 x 213)	1 ⁵ / ₈ " (41)	12	12.50

∅ = Diameter



PERSONALIZED CAMRACKS®

- Personalize Camracks to identify contents at a glance for accurate inventory control and selection.
- Hot stamp a custom logo, information or standard content symbols, and/or descriptions on two opposite, diagonal sides of any rack.
- Pre-printed clips (up to 4 per rack) can be ordered factory installed for an additional charge.



HOW TO ORDER A SAMPLE

1. Contact your local Cambro rep to complete and submit a sample request form to Cambro. Indicate location of hot stamp and/or clip on rack. Maximum hot stamp imprint size is **W 4" x H 1¼"**. Maximum hot stamp imprinting thickness per solid letter or logo should be no more than 4" wide.
2. If selecting custom hot stamping, provide ready-to-use artwork, in digital format only. Sample request form must be submitted to Cambro **PRIOR** to artwork being sent. If artwork is incomplete, graphic support services are available for \$ 50.00 per hour.
3. E-mail artwork to Cambro Rep or to Cambro at: letsgetpersonal@cambro.com. Title e-mail subject with logo name and provide contact info. **File dimensions:** 100% reproduction size, 300dpi resolution. **File type:** Adobe® Illustrator®, Photoshop®. **File format:** JPEG, TIFF or EPS.
4. Questions? Contact Kristie Patterson at 714-230-4125 direct or 800-854-7631 ext. 4125.
5. Signed approval form must be included with purchase order for processing. This form is included with each sample.

PERSONALIZATION CHARGES (NET)

One Time Plate Charge	\$ 100.00 (for custom hot stamp only)
Set-Up Charge	50.00
Sample Charge	50.00
Imprint Charge	1.00 per side, 2 sides max for hot stamping

STANDARD HOT STAMP SYMBOLS AND/OR DESCRIPTIONS

Step 1. Choose a symbol and corresponding letter that best fits your glassware.

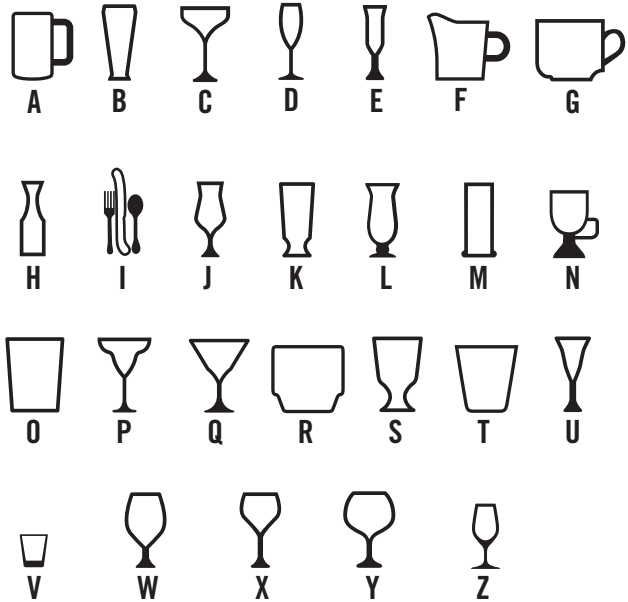

Step 2. Choose the verbiage and corresponding number that best describes your glassware. **Available in English Only.**

- | | | |
|--------------------|--------------------------|---------------------------|
| 1. Beer | 13. Flatware | 25. Rocks (Tumbler Style) |
| 2. Beer Mug | 14. Goblet | 26. Sherry |
| 3. Pilsner | 15. Grande | 27. Shot Glass |
| 4. Brandy | 16. Hi-Ball | 28. Sorbet |
| 5. Champagne | 17. Hurricane | 29. Water (Footed Style) |
| 6. Champagne Flute | 18. Iced Tea | 30. Water (Tumbler Style) |
| 7. Coffee Mug | 19. Irish Coffee | 31. White Wine |
| 8. Collins | 20. Juice | 32. Wine |
| 9. Cordial | 21. Margarita | 33. Red Wine |
| 10. Creamer | 22. Martini | 34. Port |
| 11. Cup | 23. Old Fashion | |
| 12. Decanter | 24. Rocks (Footed Style) | |

Step 3. Select hot stamp color. Choose from white, black, red or blue.

HOT STAMP OPTIONS



CUSTOM LOGO AND/OR TEXT



STANDARD SYMBOL AND DESCRIPTION



STANDARD SYMBOL ONLY



STANDARD DESCRIPTION ONLY

CAMRACK® EXTENDER ID CLIP

- The industry's only 4-in-1 glassware management system makes inventory management quick and easy.
- Made of ABS, these clips are virtually unbreakable, and designed to withstand the high heat of commercial dishwashers.
- An economical and sustainable solution to discarding existing racks or labeling with markers, tape or wall placards.
- Snap ID clips onto existing racks or have factory installed with new Camrack orders, up to 4 per rack, placed on the left only on each side as shown in image. Installation cost is \$.90 net per clip (charged in addition to actual cost per clip).



PRE-PRINTED CLIPS (Available in 6-packs only, no broken bags.) **\$ 1.90 List per clip**
FACTORY INSTALLED CLIPS \$.90 Net per clip

		CODE
	Beer	CECBE6000
	Beer Mug	CECBM6000
	Brandy	CECBR6000
	Champagne	CECCH6000
	Champagne Flute	CECCF6000
	Coffee Mug	CECCM6000
	Collins	CECCL6000
	Cordial	CECCO6000
	Creamer	CECCR6000
	Cup	CECCP6000
	Decanter	CECDC6000
	Flatware	CECFL6000

		CODE
	Goblet	CECGO6000
	Grande	CECGR6000
	Hi-Ball	CECHB6000
	Hurricane	CECHU6000
	Iced Tea	CECIT6000
	Irish Coffee	CECIC6000
	Juice	CECJU6000
	Margarita	CECMG6000
	Martini	CECMT6000
	Old Fashion	CECOF6000
	Pilsner	CECPI6000
	Red Wine	CECRW6000

		CODE
	Rocks (footed style)	CECRF6000
	Rocks (tumbler style)	CECRT6000
	Sherry	CECSH6000
	Shot Glass	CECSG6000
	Sorbet	CECSB6000
	Water (footed style)	CECWF6000
	Water (tumbler style)	CECWT6000
	White Wine	CECWW6000
	Wine	CECWI6000
	Port	CECPO6000
		CECBL6000
		Blank Clip (\$ 1.65 list per clip)

(Available in English only)

CAMDOLLIES®

- Use to easily transport multiple products in house and/or off site.
- Reduce employee lifting and carrying and possible injury.
- Made of extremely durable plastic that will not dent, crack, rust or corrode.
- Heavy-duty casters maneuver easily over all types of terrain.
- For heavy transport needs, select models with handles and Rear Big Wheels.

Colors: Coffee Beige (157), Dark Brown (131), Black (110), Slate Blue (401).
CDR2020, CDR2020H Color: Soft Gray (151).

Caster Type

- A:** 5" casters: 2 fixed, 2 swivel, 1 with brake.
B: 3" casters: 4 swivel, no brakes.
C: 10" rear big wheels, 2 front 5" swivel casters, 1 with brake.
D: 3½" casters: 4 swivel, no brakes.

Case Pack: 1

Camdollies for Camracks®

CODE	CDR2020
EXTERNAL DIM. W x D x H	21½" x 20⅞" x 7⅞"
INTERIOR DIM. W x D	20⅞" x 20⅞"
LIST PRICE EACH	\$ 180.25

350 lbs. CAPACITY	D CASTER TYPE		
----------------------	------------------	---	---



InStock Color:
Soft Gray (151)

CODE	CDR2020H
EXTERNAL DIM. W x D x H	20⅞" x 25¼" x 36½"
INTERIOR DIM. W x D	20⅞" x 20⅞"
LIST PRICE EACH	\$ 288.40

350 lbs. CAPACITY	D CASTER TYPE		
----------------------	------------------	---	---



With powder coated handle.

CODE	CD2020
EXTERNAL DIM. W x D x H	22½" x 22½" x 8¼"
INTERIOR DIM. W x D	20⅞" x 20⅞"
LIST PRICE EACH	\$ 309.00

300 lbs. CAPACITY	B CASTER TYPE			
----------------------	------------------	---	---	---



CODE	CD2020H
EXTERNAL DIM. W x D x H	22⅞" x 25¼" x 36⅞"
INTERIOR DIM. W x D	20⅞" x 20⅞"
LIST PRICE EACH	\$ 484.10

350 lbs. CAPACITY	B CASTER TYPE		
----------------------	------------------	---	---



CODE	CD2020HB
EXTERNAL DIM. W x D x H	26¼" x 26½" x 36⅞"
INTERIOR DIM. W x D	20⅞" x 20⅞"
LIST PRICE EACH	\$ 623.15

350 lbs. CAPACITY	C CASTER TYPE		
----------------------	------------------	---	---



Camdollies for 18" x 26" Trays or Sheet Pans

CODE	CD1826H
EXTERNAL DIM. W x D x H	20" x 31½" x 38¼"
INTERIOR DIM. W x D	18" x 26"
LIST PRICE EACH	\$ 566.50

300 lbs. CAPACITY	A CASTER TYPE		
----------------------	------------------	---	---



CODE	CD1826HB
EXTERNAL DIM. W x D x H	23½" x 32½" x 36½"
INTERIOR DIM. W x D	18½" x 26⅞"
LIST PRICE EACH	\$ 700.40

300 lbs. CAPACITY	C CASTER TYPE		
----------------------	------------------	---	---



CAMDOLLIES®

For Milk Crates and #10 Can Cases

CODE	CD1420
EXTERNAL DIM. W x D x H	16 ¹ / ₄ " x 21 ³ / ₄ " x 8 ⁵ / ₁₆ "
INTERIOR DIM. W x D	13 ⁷ / ₈ " x 19 ⁵ / ₁₆ "
LIST PRICE EACH	\$ 303.85

Holds: 14" x 19" milk crates and #10 can cases.

350 lbs. CAPACITY	B CASTER TYPE	 
-----------------------------	-------------------------	---



CODE	CD2028
EXTERNAL DIM. W x D x H	21 ⁷ / ₈ " x 30 ³ / ₄ " x 8 ¹ / ₄ "
INTERIOR DIM. W x D	19 ¹ / ₂ " x 27 ⁷ / ₈ "
LIST PRICE EACH	\$ 319.30

Holds: 14" x 19" milk crates, #10 can cases and UPC101, UPC400, 100MPC, UPC100, UPC300.

350 lbs. CAPACITY	B CASTER TYPE	 
-----------------------------	-------------------------	---



CODE	CD1313
EXTERNAL DIM. W x D x H	16 ⁷ / ₈ " x 16 ⁷ / ₈ " x 8 ¹ / ₄ "
INTERIOR DIM. W x D	13 ¹ / ₁₆ " x 13 ¹ / ₁₆ "
LIST PRICE EACH	\$ 283.25

Holds: 13" x 13" milk crates.

250 lbs. CAPACITY	B CASTER TYPE	 
-----------------------------	-------------------------	---



CODE	CD1327
EXTERNAL DIM. W x D x H	16" x 29" x 8 ¹ / ₄ "
INTERIOR DIM. W x D	13 ⁵ / ₈ " x 26 ⁵ / ₈ "
LIST PRICE EACH	\$ 303.85

Holds: 13" x 13" milk crates and #10 can cases.

300 lbs. CAPACITY	B CASTER TYPE	 
-----------------------------	-------------------------	---



UTILITY TRUCKS

- Use for transporting loads up to 600 lbs.
- Large platforms for convenient loading and built-in handles for easy maneuvering.
- All models feature 5" (12,7 cm) heavy-duty casters bolted into molded-in metal backing plates.

Colors: Coffee Beige (157), Dark Brown (131), Black (110), Slate Blue (401).

Casters: 5", 2 fixed, 2 swivel, 1 with brake.

Case Pack: 1

CODE	2030UT
EXTERNAL DIM. W x D x H	19 ³ / ₄ " x 32 ⁵ / ₈ " x 38 ¹ / ₂ "
LOAD PLATFORM	19 ³ / ₄ " x 29 ⁵ / ₈ "
LIST PRICE EACH	\$ 772.50

600 lbs. CAPACITY	
-----------------------------	--



With chrome handle.

CODE	2436UTH
EXTERNAL DIM. W x D x H	24 ⁷ / ₈ " x 41 ³ / ₄ " x 36 ³ / ₄ "
LOAD PLATFORM	23 ⁵ / ₈ " x 35 ⁵ / ₈ "
LIST PRICE EACH	\$ 726.15

600 lbs. CAPACITY	
-----------------------------	--



CODE	UTHSTP (STRAP)
DIMENSION	200" long
LIST PRICE EACH	\$ 17.50



CODE	2436UTHS
EXTERNAL DIM. W x D x H	24 ⁷ / ₈ " x 41 ³ / ₄ " x 36 ³ / ₄ "
LOAD PLATFORM	23 ⁵ / ₈ " x 35 ⁵ / ₈ "
LIST PRICE EACH	\$ 772.50

600 lbs. CAPACITY	
-----------------------------	--



Includes two straps. UTHSTP

TRAY & DISH CARTS / TRAY & SILVERWARE CART

Tray & Dish Cart

- Open storage compartment holds a wide variety of plates and trays.
- Use with or without detachable cutlery rack. Cutlery rack includes 12 each flatware cylinders.
- Made of easy-to-clean polyethylene that won't rust, peel or corrode.
- Molded-in handles and heavy-duty swivel casters ease maneuvering.

Colors: Slate Blue (401), Coffee Beige (157), Dark Brown (131), Granite Gray (191), Granite Green (192), Black (110).

6" Casters: All swivel, 2 with brake.

Maximum load capacity: 500 lbs.

Vinyl cover included. Not NSF listed.



TDCR12

CODE	DESCRIPTION	DIMENSIONS L x W x H	LIST PRICE EA.
TDCR12	Cart and rack combination	38 $\frac{3}{8}$ " x 22 $\frac{3}{4}$ " x 41 $\frac{1}{4}$ "	\$ 1,467.75
TDC2029*	Cart only	38 $\frac{3}{8}$ " x 22 $\frac{3}{4}$ " x 34 $\frac{1}{4}$ "	1,117.55
CR12	Cutlery rack only	33" x 22 $\frac{3}{4}$ " x 9"	314.15
FWC56	Flatware cylinder	—	4.80

Case Pack: 1 FWC56 Case Pack: 12 *TDC2029 is not available in Black (110).

Adjustable Tray & Dish Cart

- Use to store a wide variety of plates and trays.
- Move two adjustable dividers into position easily to secure trays and plates.

- Made of durable polyethylene that cushions plates and trays to prevent chipping.
- Easy to clean and won't dent, rust, chip or break.

Colors: Black (110), Slate Blue (401), Coffee Beige (157), Dark Brown (131), Granite Gray (191), Granite Green (192).

6" Casters: All swivel, 2 with brake.

Maximum load capacity: 500 lbs.

Vinyl cover included. Not NSF listed.



TDC30

CODE	DESCRIPTION	EXTERIOR DIMENSIONS L x W x H	NUMBER OF DIVIDERS	PLATES PER COLUMN	TRAYS PER COLUMN	LIST PRICE EA.
TDC30	Adjustable cart	23 $\frac{1}{4}$ " x 38 $\frac{3}{8}$ " x 34 $\frac{1}{2}$ "	2	Approximately 45-60 plates	80 trays: 14" x 18"	\$ 1,462.60

Case Pack: 1

Tray & Silverware Cart

- Use to neatly organize trays and accessories for self-service.
- Includes 4 each 1/3 size and 4 each 1/6 size, 4" deep, clear Camwear® food pans to hold flatware, napkins and non-perishable condiments. 1/3 size, 4" deep holds 100 knives, 100 spoons or 80 forks.

Colors: Slate Blue (401), Coffee Beige (157), Dark Brown (131), Granite Gray (191), Granite Green (192), Black (110).

6" Casters: All swivel, 2 with brake.

Maximum load capacity: 500 lbs.

Vinyl cover included. Not NSF listed.



TC1418

CODE	DESCRIPTION	EXTERIOR DIMENSIONS L x W x H	MAXIMUM TRAY SIZE	TRAY CAPACITY	LIST PRICE EA.
TC1418	Cart with pans	32 $\frac{3}{8}$ " x 21 $\frac{1}{4}$ " x 45 $\frac{1}{2}$ "	14" x 18"	180-200 in two stacks	\$ 1,256.60

Case Pack: 1

STANDARD ADJUSTABLE DISH CADDY S-SERIES

- Store one size dish or a combination of different sizes in a single caddy.
- Features easy-to-adjust column towers.

Colors: Black (110), Slate Blue (401), Speckled Gray (480), Dark Brown (131).

Casters: 5", 2 swivel with brakes and two 10" Easy wheels.

Vinyl cover included. Not NSF listed.

For square and rectangular plates, please contact Cambro for suggested use.



Holds plates and bowls from 4⁵/₈" to 13"

Single Size Plate Storage



Plate sizes: 9³/₄" to 13" diam.
4 columns: (60 each)
Total Capacity: 240



Plate sizes: 7¹/₄" to 9" diam.
6 columns: (60 each)
Total Capacity: 360

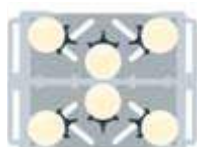

Plate sizes: 5³/₄" to 7" diam.
6 columns: (45 each)
Total Capacity: 270

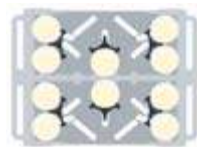
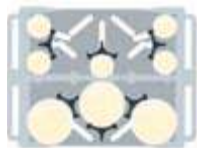

Plate sizes: 4⁵/₈" to 6⁵/₈" diam.
10 columns: (45 each)
Total Capacity: 450

Mixed Size Plate Storage



2 columns: 9³/₄" to 13" diam. (60 each)
5 columns: 4³/₄" (45 each)
Total Capacity: 345



3 columns: 7¹/₄" to 9" diam. (60 each)
5 columns: 4³/₄" (45 each)
Total Capacity: 405



2 columns: 7¹/₄" to 9" diam. (60 each)
2 columns: 5³/₄" to 7" (45 each)
4 columns: 4³/₄" (45 each)
Total Capacity: 390

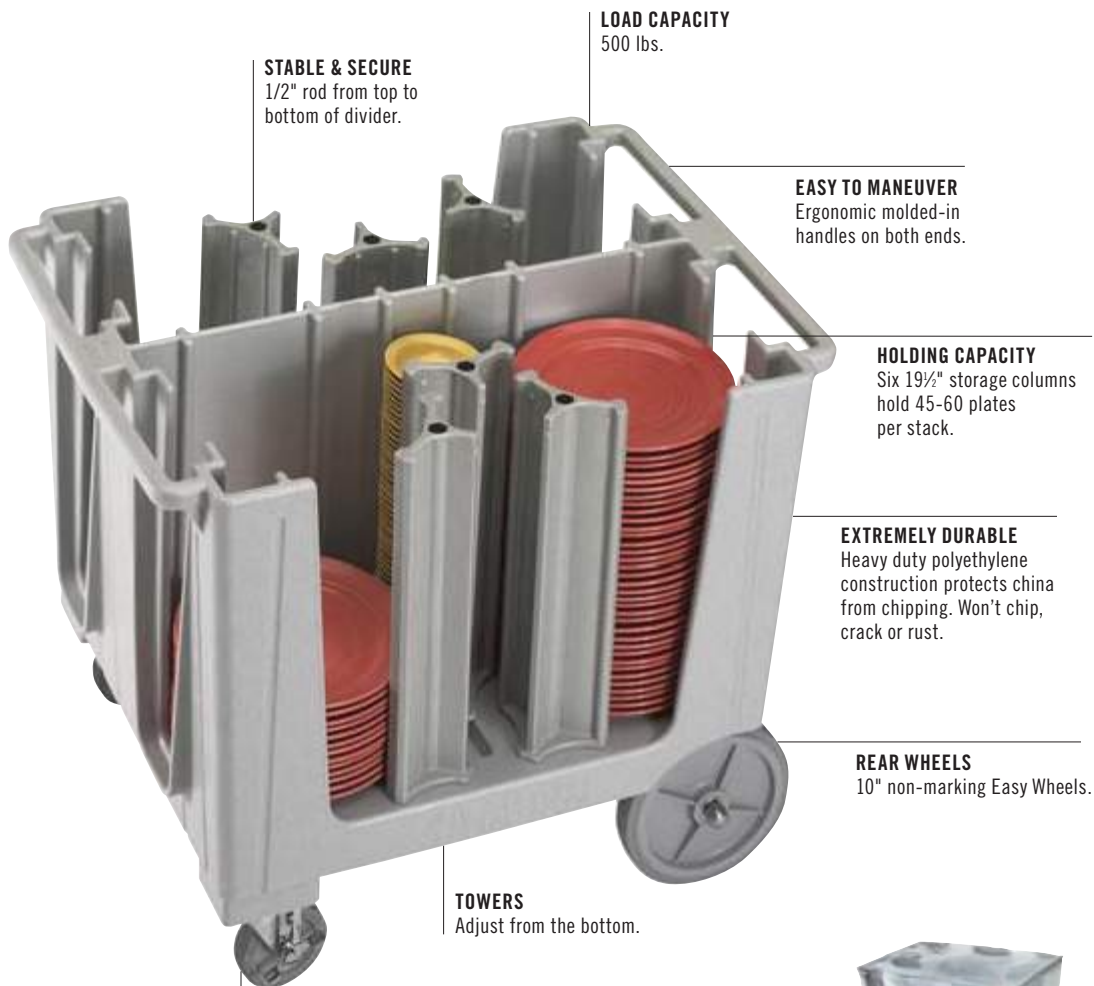

Vinyl cover included with every dolly for sanitary storage.

CODE	ADCS
NUMBER OF TOWERS	6
PLATES PER COLUMN	Approximately 45-60
OVERALL DIMENSIONS W x L x H	28 ⁵ / ₈ " x 37 ⁷ / ₈ " x 31 ¹ / ₈ "
LIST PRICE EACH	\$ 1,369.90

Case Pack: 1
InStock Colors: Black (110), Speckled Gray (480).

COMPACT ADJUSTABLE DISH CADDY S-SERIES

- Space saving design holds dishes of various sizes without compromising capacity.
- Lightweight, easy to maneuver and access from all four sides.

Color: Speckled Gray (480).
5" Casters: All zinc plated, non marking casters, all swivel with brake.
Note: Cannot be used to store square, rectangular or oval plates.
 Compact Adjustable Dish Caddy is covered by U.S. Patent 10,321,778 B2. CamLever Tower is covered by U.S. Patent D844, 928 S and D852,450 S.
 Vinyl cover included. Not NSF Listed.



Holds plates and bowls from 4⁵/₈" to 12"



Column storage height - 20 1/2".

Maximum load capacity: 500 lbs.

Molded-in handles on 4 sides.

Single molded body made of heavy-duty, durable polyethylene won't rust, crack, dent or chip.



Conveniently move and secure CamLever Towers from the top.

Holds 4⁵/₈" - 12" round plates/bowls only, 45 - 70 per stack, based on dish style and number of plates/bowls per stack.

Smooth surface with rounded corners is easy to keep clean.



Includes protective storage cover with 3" x 5" inventory and/or event identification top pocket.

Gain 30% More Floor Space

Compact Adjustable Dish Caddy compared to Standard Adjustable Dish Caddy S-Series.

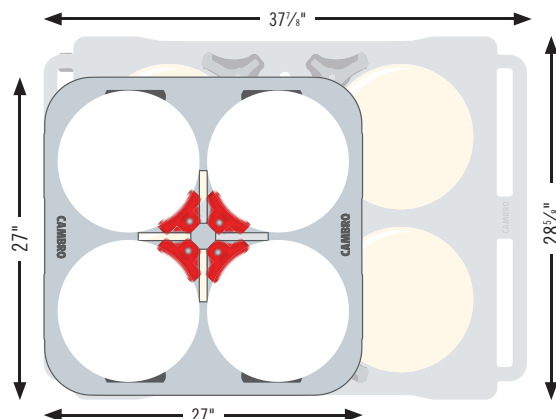

CamLever Tower

ADCSC4
DESCRIPTION:
 CamLever Tower - 4 Each
OVERALL DIMENSIONS W x D x H:
 2⁵/₈" x 4³/₈" x 23¹/₂"
LIST PRICE PER CASE: \$ 295.00
Case Pack: 4



Conveniently install additional CamLever Towers to convert the ADCSC to an ADCSC8PKG (8-tower) or an ADCSC12PKG (12-tower) model, holding new dish sizes.

COMPACT ADJUSTABLE DISH CADDY S-SERIES



ADCSC

DESCRIPTION:
Adjustable Dish Caddy, 4 Towers

PLATE SIZE RANGE (ROUNDS):
9" to 12"

OVERALL DIMENSIONS W x D x H:
27" x 27" x 31¼"

LIST PRICE EACH: \$ 1,150.00

Case Pack: 1 Ships in 1 box.



ADCSC8PKG

DESCRIPTION:
Adjustable Dish Caddy, 8 Towers

PLATE SIZE RANGE (ROUNDS):
5¾" to 8¾"

OVERALL DIMENSIONS W x D x H:
27" x 27" x 31¼"

LIST PRICE EACH: \$ 1,445.00

Case Pack: 1 Ships in 2 boxes.



ADCSC12PKG

DESCRIPTION:
Adjustable Dish Caddy, 12 Towers

PLATE SIZE RANGE (ROUNDS):
4½" to 5½"

OVERALL DIMENSIONS W x D x H:
27" x 27" x 31¼"

LIST PRICE EACH: \$ 1,740.00

Case Pack: 1 Ships in 3 boxes.

Model: ADCSC, 4 Towers

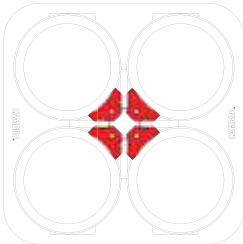

Plate sizes: 9¾" to 12" diam.
Stacks of Plates: 4
Total Capacity: 280

Model: ADCSC8PKG, 8 Towers

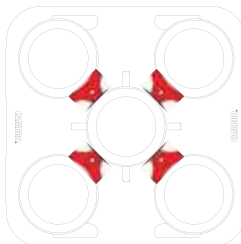

Plate sizes: 9" diam.
Stacks of Plates: 5
Total Capacity: 350

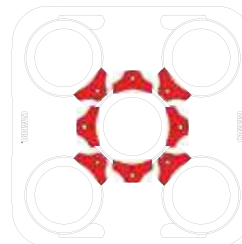

Plate sizes: 7¾" to 8¾" diam.
Stacks of Plates: 5
Total Capacity: 350

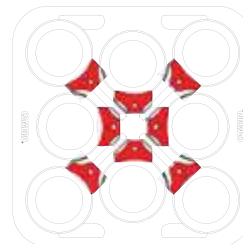

Plate sizes: 5¾" to 7½" diam.
Stacks of Plates: 8
Total Capacity: 560

Model: ADCSC12PKG, 12 Towers

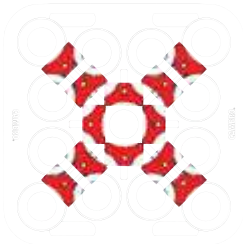

Plate sizes: 4½" diam.
Stacks of Plates: 16
Total Capacity: 1,120

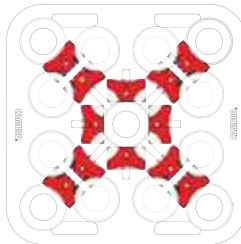

Plate sizes: 4¾" to 5¼" diam.
Stacks of Plates: 13
Total Capacity: 910

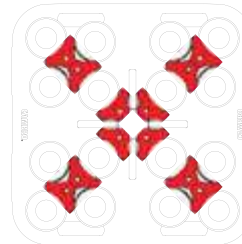

Plate sizes: 5½" diam.
Stacks of Plates: 13
Total Capacity: 910

POKER CHIP "FIXED" NON ADJUSTABLE DISH CADDIES

- Dividers are molded into the body in a standard poker chip design.
- Made of durable polyethylene that protects plates from chipping.
- Rear big wheels and front swivel casters provide smooth maneuvering.
- Open access from two sides for easy loading and unloading.
- Molded-in handles on both ends for easy transporting.

Standard Caddy Colors: Black (110), Slate Blue (401), Dark Brown (131), Granite Gray (191).

Versa Caddy Colors: Black (110), Dark Brown (131), Speckled Gray (480).

Casters: 2, 5" swivel with brakes and two 10" Easy Wheels.

Loading Capacity: 500 lbs.

Vinyl cover included. Not NSF listed.

DCS950 is covered by U.S. Patent D 603,120 S. DCS1125 is covered by U.S. Patent D 625,894.



Standard Dish Caddies



DC575

PLATE SIZE RANGE (ROUNDS):
Up to 5 $\frac{1}{4}$ "

STACKS PER CADDY: 6

PLATES PER STACK: 45-60

OVERALL DIMENSIONS W x L x H:
32 $\frac{3}{8}$ " x 23 $\frac{1}{2}$ " x 31 $\frac{3}{4}$ "

LIST PRICE EACH: \$ 1,117.55

Case Pack: 1



DC700

PLATE SIZE RANGE (ROUNDS):
5 $\frac{1}{8}$ " - 7"

STACKS PER CADDY: 6

PLATES PER STACK: 45-60

OVERALL DIMENSIONS W x L x H:
32 $\frac{3}{8}$ " x 23 $\frac{1}{2}$ " x 31 $\frac{3}{4}$ "

LIST PRICE EACH: \$ 1,117.55

Case Pack: 1



DC825

PLATE SIZE RANGE (ROUNDS):
7 $\frac{1}{8}$ " - 8 $\frac{1}{4}$ "

STACKS PER CADDY: 4

PLATES PER STACK: 45-60

OVERALL DIMENSIONS W x L x H:
28 $\frac{3}{4}$ " x 23 $\frac{3}{4}$ " x 32"

LIST PRICE EACH: \$ 1,117.55

Case Pack: 1



DC1225

PLATE SIZE RANGE (ROUNDS):
11 $\frac{1}{8}$ " - 12 $\frac{1}{4}$ "

STACKS PER CADDY: 4

PLATES PER STACK: 45-60

OVERALL DIMENSIONS W x L x H:
32 $\frac{3}{4}$ " x 27 $\frac{1}{2}$ " x 32"

LIST PRICE EACH: \$ 1,184.50

Case Pack: 1

Versa Dish Caddies



DCS950

PLATE SIZE RANGE (ROUNDS):
8 $\frac{3}{8}$ " - 9 $\frac{1}{2}$ "

PLATE SIZE RANGE (SQUARES):
7 $\frac{1}{4}$ " - 8"

STACKS PER CADDY: 5

PLATES PER STACK: 45-60

OVERALL DIMENSIONS W x L x H:
27" x 30 $\frac{1}{2}$ " x 31 $\frac{3}{4}$ "

LIST PRICE EACH: \$ 1,076.35

Case Pack: 1
InStock Colors: Black (110), Speckled Gray (480).



DCS1125

PLATE SIZE RANGE (ROUNDS):
9 $\frac{3}{8}$ " - 11 $\frac{1}{4}$ "

PLATE SIZE RANGE (SQUARES):
8 $\frac{3}{8}$ " - 9 $\frac{1}{2}$ "

STACKS PER CADDY: 4

PLATES PER STACK: 45-60

OVERALL DIMENSIONS W x L x H:
27" x 30 $\frac{1}{2}$ " x 31 $\frac{3}{4}$ "

LIST PRICE EACH: \$ 1,122.70

Case Pack: 1
InStock Colors: Black (110), Speckled Gray (480).



KD SERVICE CART AND KD UTILITY CART

- Versatile, durable and economically-priced carts.
- Marine rails and lightly-textured polypropylene shelves keep contents in place.
- Aluminum uprights ensure stability.
- Ships “knocked down” to minimize shipping costs.
- Easy to assemble.

Cart and Shelf Panel Set Colors:
Black (110), Speckled Gray (480).

Trash Container and Silverware Holder Color: Black (110).



Each BC340KD shelf holds one full-sized dish rack or two standard bus boxes.

Marine rails keep contents in place.

Optional shelf panels can be added at time of assembly to enclose three sides. (KD Utility Cart only.)

Sturdy aluminum uprights.

Four powder coated steel swivel casters provide quiet transport and steady maneuvering.

BC340KD

Durable, stain-resistant surface is easy to clean.



BC331KD

CODE	BC340KD	BC331KD
DESCRIPTION	Large Utility Cart	Small Service Cart
CASTER DIA./TYPE	5", 4 swivel, no brake	4", 4 swivel, no brake
OVERALL DIM. L x D x H	40" x 21¼" x 37½"	32⅞" x 16¼" x 38"
SHELF DIM. L x D x H	31½" x 20½" x 11¾"	24⅜" x 15⅞" x 11¾"
LOAD CAPACITY	400 lbs.	300 lbs.
LIST PRICE EACH	\$ 321.00	\$ 216.00

Case Pack: 1 InStock Colors: Black (110), Speckled Gray (480).

Optional Accessories



CODE	BC331KDTC	BC331KDSH	BC340KDP
DESCRIPTION	8 gal. Trash container	2.5 gal. Silverware holder	Single Shelf Panel Set for KD Large Utility Cart 1 side, 2 ends
DIM. W x D x H	13" x 9½" x 22"	13" x 9½" x 7¼"	31⅝" x 17¼" x 11¾"
LIST PRICE EACH	\$ 88.00	\$ 50.60	\$ 88.00

Case Pack: 1

SERVICE CART PRO

- Ideal for front or back of house foodservice operations.
- Optional Quick Connect Bins provide extra storage while keeping items sanitary.
- Ergonomic, recessed handles are molded into both ends of the cart for easy maneuvering and a smaller footprint.
- Durable, one-piece polyethylene construction. Easy to clean.
- Shelves feature raised ridges to protect surface against heat.

Colors: Black (110), Dark Brown (131), Charcoal Gray (615).

Total weight capacity: 600 lbs., 200 lbs. per shelf.

Patent Pending.



Top Shelf interior dimensions: 32³/₄" x 19¹/₄".



Middle and Bottom Shelf interior dimensions: 34³/₈" x 21³/₄" x 10³/₁₆".



Heavy-duty, non-marking 6" plate casters.



QCTB

QCSB

CODE	DESCRIPTION	EXTERIOR DIM. L x W x H	LIST PRICE EA.
Service Cart Pro			
SC337	Standard Service Cart Casters: 2 rigid, 2 swivel with brake	41 ¹ / ₂ " x 23 ³ / ₈ " x 37"	\$ 1,015.00
SC337S	Standard Service Cart Casters: 4 swivel with brake	41 ¹ / ₂ " x 23 ³ / ₈ " x 37"	1,040.00
Optional Accessories			
QCSB	Small Quick Connect Bin	16" x 7" x 12 ³ / ₈ "	90.00
QCTB	Large Quick Connect Bin	16" x 7" x 21 ³ / ₈ "	103.00

Case Pack: 1

SERVICE CARTS

- All-purpose versatile, durable and dependable workhorses.
- Ideal for use on the receiving dock or setting up and bussing tables.
- Made of one-piece, polyethylene with molded-in handles and shelves.
- Choose from models with open or enclosed sides.

Colors: Black (110), Slate Blue (401), Dark Brown (131), Coffee Beige (157), Granite Gray (191).

BC225, BC2254S, BC11TC and BC1115SH can be shipped by parcel carrier.



Open Carts



BC225
CASTER DIA./TYPE:
 3", 2 fixed, 2 swivel, 1 w/brake
OVERALL DIMENSIONS L x D x H:
 28" x 16" x 32¼"
SHELF DIMENSIONS L x D x H:
 21¼" x 15½" x 11¼"
LOAD CAPACITY: 350 lbs.
LIST PRICE EACH: \$ 623.15
Case Pack: 1



BC2254S
CASTER DIA./TYPE:
 3", 4 swivel, 1 w/brake
OVERALL DIMENSIONS L x D x H:
 28" x 16" x 32¼"
SHELF DIMENSIONS L x D x H:
 21¼" x 15½" x 11¼"
LOAD CAPACITY: 350 lbs.
LIST PRICE EACH: \$ 643.75
Case Pack: 1



BC230
CASTER DIA./TYPE:
 5", 2 fixed, 2 swivel, 1 w/brake
OVERALL DIMENSIONS L x D x H:
 33¾" x 20" x 34⅝"
SHELF DIMENSIONS L x D x H:
 27" x 19½" x 11¼"
LOAD CAPACITY: 500 lbs.
LIST PRICE EACH: \$ 787.95
Case Pack: 1



BC2304S
CASTER DIA./TYPE:
 5", 4 swivel, 1 w/brake
OVERALL DIMENSIONS L x D x H:
 33¾" x 20" x 34⅝"
SHELF DIMENSIONS L x D x H:
 27" x 19½" x 11¼"
LOAD CAPACITY: 500 lbs.
LIST PRICE EACH: \$ 808.55
Case Pack: 1



BC235
CASTER DIA./TYPE:
 5", 2 fixed, 2 swivel, 1 w/brake
OVERALL DIMENSIONS L x D x H:
 37¼" x 21½" x 34⅝"
SHELF DIMENSIONS L x D x H:
 31½" x 20⅝" x 11⅝"
LOAD CAPACITY: 500 lbs.
LIST PRICE EACH: \$ 854.90
Case Pack: 1



BC2354S
CASTER DIA./TYPE:
 5", 4 swivel, 1 w/brake
OVERALL DIMENSIONS L x D x H:
 37¼" x 21½" x 34⅝"
SHELF DIMENSIONS L x D x H:
 31½" x 20⅝" x 11⅝"
LOAD CAPACITY: 500 lbs.
LIST PRICE EACH: \$ 875.50
Case Pack: 1



BC330
CASTER DIA./TYPE:
 5", 2 fixed, 2 swivel, 1 w/brake
OVERALL DIMENSIONS L x D x H:
 33⅝" x 20" x 34⅝"
SHELF DIMENSIONS L x D x H:
 27" x 18½" x 11¼"
LOAD CAPACITY: 500 lbs.
LIST PRICE EACH: \$ 849.75
Case Pack: 1



BC3304S
CASTER DIA./TYPE:
 5", 4 swivel, 1 w/brake
OVERALL DIMENSIONS L x D x H:
 33⅝" x 20" x 34⅝"
SHELF DIMENSIONS L x D x H:
 27" x 18½" x 11¼"
LOAD CAPACITY: 500 lbs.
LIST PRICE EACH: \$ 870.35
Case Pack: 1

Optional Accessories

CODE	BC11TC*	BC1115SH*
DESCRIPTION	11 gal. trash container	1.75 gal. silverware holder
DIMENSIONS W x D x H	13¾" x 8⅞" x 21⅞"	14½" x 6" x 5⅝"
LIST PRICE EACH	\$ 92.70	\$ 82.40

Case Pack: 1 *BC11TC & BC1115SH will not fit KD Service or Utility Carts. BC11TC & BC1115SH are available in Black (110) and Dark Brown (131).



BC11TC



BC1115SH

CAMBOX® BUS BOXES

Regal



CODE	1120CBR	1520CBR
DESCRIPTION	Four compartment cutlery box	15" x 20" Cambox
DIM. W x L x H	11 ³ / ₈ " x 20 ⁷ / ₁₆ " x 3 ³ / ₄ "	15 ⁵ / ₁₆ " x 19 ¹⁵ / ₁₆ " x 4 ¹⁵ / ₁₆ "
LIST PRICE EACH	\$ 24.75	\$ 25.35

Case Pack: 12 Colors: Black (110), Dark Brown (131).



CODE	21155CBR	21157CBR	1722CBR
DESCRIPTION	15" x 21" x 5" Cambox	15" x 21" x 7" Cambox	17" x 22" Cambox
DIM. W x L x H	15 ¹ / ₄ " x 20 ¹ / ₄ " x 4 ¹⁵ / ₁₆ " (includes handle)	15 ⁵ / ₁₆ " x 20 ³ / ₁₆ " x 6 ¹⁵ / ₁₆ "	16 ⁷ / ₈ " x 21 ⁷ / ₈ " x 4 ³ / ₄ "
COVER	2115CBCR	2115CBCR	1722CBCP
LIST PRICE EACH	\$ 29.70	\$ 34.25	\$ 32.90

Case Pack: 12 Colors: Black (110), Dark Brown (131).

Poly



CODE	415CBP	912CBP	1120CBP	1520CBP	1520CBPF*
DESCRIPTION	Cutlery box	Utility box	11" x 20" Cambox	15" x 20" Cambox	15" x 20" Cambox
DIM. W x L x H	4 ¹ / ₁₆ " x 14 ³ / ₁₆ " x 4 ¹ / ₈ "	9 ¹ / ₁₆ " x 12 ¹ / ₁₆ " x 5 ¹ / ₈ "	11 ³ / ₈ " x 20 ⁷ / ₁₆ " x 3 ³ / ₄ "	15 ⁵ / ₁₆ " x 19 ¹⁵ / ₁₆ " x 4 ¹⁵ / ₁₆ "	15 ⁵ / ₁₆ " x 19 ¹⁵ / ₁₆ " x 4 ¹⁵ / ₁₆ "
COVER	—	—	—	1520CBCP	1520CBCP
LIST PRICE EACH	\$ 8.55	\$ 11.65	\$ 18.60	\$ 19.15	\$ 19.15

Case Pack: 12 Colors: Black (110), Dark Brown (131), Light Gray (180).
InStock Color: Light Gray (180). *1520CBPF is identical to 1520CBP except the internal surface is flat.



CODE	1621CBP	21155CBP	21157CBP	1722CBP
DESCRIPTION	15" x 20" Cambox	15" x 21" x 5" Cambox	15" x 21" x 7" Cambox	17" x 22" Cambox
DIM. W x L x H	15 ⁵ / ₈ " x 20 ¹ / ₂ " x 4 ⁷ / ₈ "	15 ¹ / ₄ " x 20 ¹ / ₄ " x 4 ¹⁵ / ₁₆ " (includes handle)	15 ⁵ / ₁₆ " x 20 ³ / ₁₆ " x 6 ¹⁵ / ₁₆ "	16 ⁷ / ₈ " x 21 ⁷ / ₈ " x 4 ³ / ₄ "
COVER	—	2115CBCP	2115CBCP	1722CBCP
LIST PRICE EACH	\$ 29.00	\$ 21.60	\$ 23.30	\$ 23.30

Case Pack: 12 Colors: Black (110), Dark Brown (131), Light Gray (180). InStock Color: Light Gray (180).

Covers



CODE	1520CBP	1722CBP	2115CBP	2115CBP
DIM. W x L	16" x 20 ¹ / ₂ "	17 ¹ / ₁₆ " x 22 ³ / ₈ "	15 ¹ / ₂ " x 20 ¹ / ₂ "	15 ¹ / ₂ " x 20 ¹ / ₂ "
LIST PRICE EACH	\$ 15.55	\$ 28.00	\$ 15.50	\$ 15.45

Case Pack: 12 Color: White (148).



SHELVING





When we say Shelving for Life, we mean it. All Camshelving® storage systems are designed to withstand the toughest conditions and the harshest environments. With our lifetime warranty against rust and corrosion, only Cambro offers SHELIVING for LIFE™.



Cambro storage and transportation products that support safe food handling.



COMPONENT

Products that meet the NSF International criteria for sanitation and cleanability.



Products that help meet HACCP guidelines.



Fit for food products



Dishwasher Safe



Cadmium-free products



Recyclable polypropylene



Antimicrobial protection permanently molded into shelf plates to inhibit the growth of mold, fungus and bacteria.

Camshelving® is covered under the following US Patents:

D498,664 S, D508,646 S, D512,867 S, D623,929 S, D624,764 S, D648,582 S, D630,935 S, D648,159 S, D651,433 S, D648,160 S, D697,391 S, D727,715 S, D728,347 S, D728,348 S, D707,994 S, D739,989 S, D663,912 S, D736,488 S, D739,989 S, D760,519 S, D841, 273 S, D828, 145 S, D827, 421 S US 6,981,454B2

CAMSHELVING®

SHELVING for LIFE™

KEY FEATURES OF ALL CAMSHELVING SERIES



Rust and Corrosion Free

Backed by a lifetime warranty against rust and corrosion. All Camshelving is impervious to harsh chemicals and salt water.

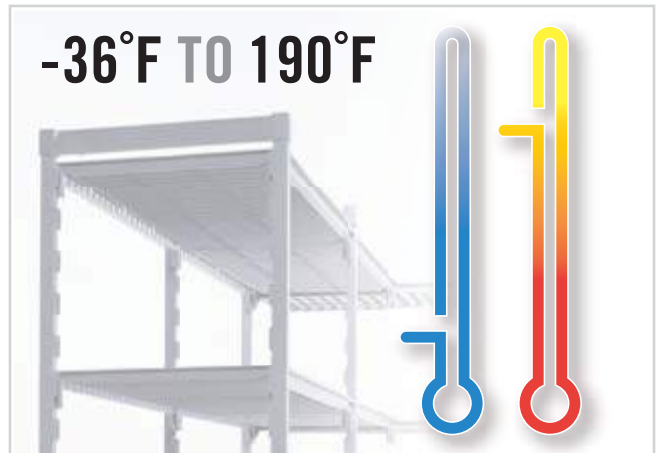

All Environments

Camshelving is designed to withstand all extreme storage applications and temperatures.

- Coolers
- Freezers
- Dry Storage
- Utility

Maximized Space Utilization

Shelving units are designed to be interconnected, without compromising weight-bearing capacity, all while maximizing usable storage space.

Starter Unit

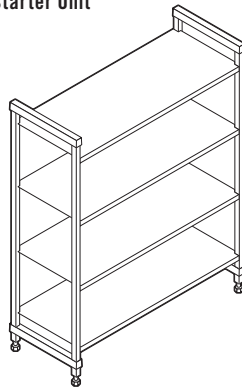

Starter + Add-On Unit

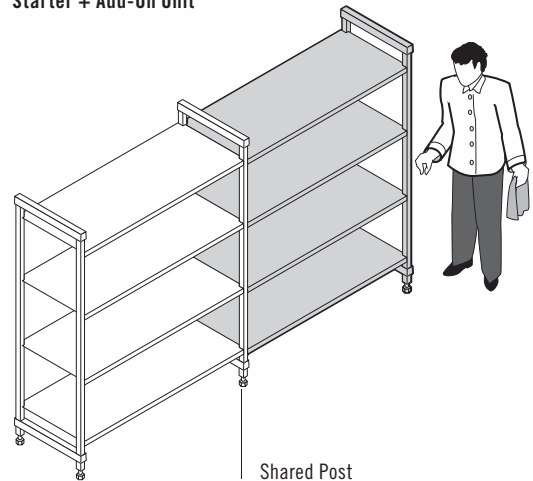

PREMIUM series

ELEMENTS series

BASICS PLUS series



Easy to Clean

Camshelving easily wipes clean or shelf plates can go through the dishwasher. Camguard® antimicrobial shelf plates inhibit the growth of harmful bacteria and microbes.



Easy to Assemble & Adjust

Units ship with preassembled frames to speed up installation. Each shelf can be easily and independently adjusted.

Corner Unit
Starter + Add-On Unit

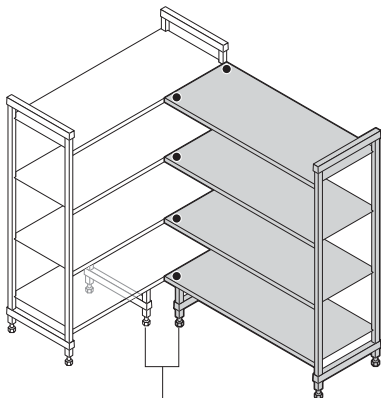

Bottom Shelf
Dunnage Stands

U-Shape Unit
Two Starter Units +
Intermediate Shelves

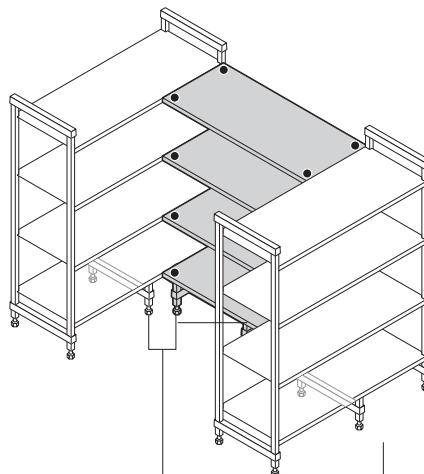

T-Shape Unit
Starter unit + Add-on Unit

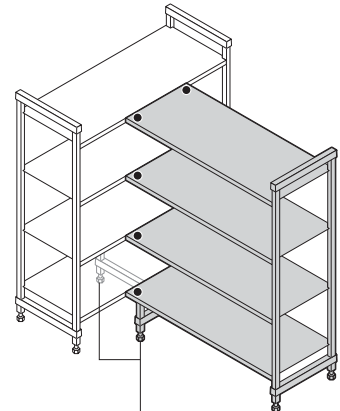

Convert unusable space into continuous, easy-access storage areas with corner connectors. ● Corner connectors are for use only with shelves 24" - 48" long.

CAMSHELVING® SERIES BUYERS GUIDE

All Camshelving lines offer a lifetime warranty against rust and corrosion for shelf plates, posts and traverses.



	PREMIUM series	ELEMENTS series	BASICS PLUS series
Shelf Depths	14", 18", 21", 24"	14", 18", 21", 24"	18", 21", 24"
Shelf Lengths	24", 30", 36", 42", 48", 54", 60", 72"	24", 30", 36", 42", 48", 54", 60", 72"	30", 36", 42", 48", 54", 60"
Post Heights	Stationary: 32", 56", 64", 72", 84" Mobile: 35", 59", 67", 75" (includes casters)	Stationary: 30", 64", 72", 84" Mobile: 27", 70", 78" (includes casters)	Stationary: 64", 72", 84"
Weight-Bearing Capacity (based on 24"- 48" length)	Stationary Unit: 800 lbs. per shelf, 2000 lbs. per unit. Mobile Unit: 750 lbs. per unit. Corner Unit: 400 lbs. per shelf, 1800 lbs. per unit.	Stationary Unit: 800 lbs. per shelf, 2000 lbs. per unit. Mobile Unit: 750 lbs. per unit. Corner Unit: 400 lbs. per shelf, 1800 lbs. per unit.	Stationary Unit: 600 lbs. per shelf, 1800 lbs. per unit. Corner Unit: 300 lbs. per shelf, 1350 lbs. per unit.
Shelf Plates	Interchangeable with Elements Series. Features Camguard® antimicrobial.	Interchangeable with Premium Series. Features Camguard antimicrobial.	Not interchangeable with Premium or Elements Series.
Mobility	Available in Mobile and High Density Storage System.	Available in Mobile.	Not available.
Assembly	Quickest and easiest to assemble due to molded-in dovetails.	Simple to assemble. Contains separate dovetails that must be attached to the post.	Simple to assemble. Contains separate dovetails that must be attached to the post.
ACCESSORIES			
Bottom Shelf Dunnage Stand	✓	✓	✓
Shelf Rails	✓	✓	✓
Vertical Drying and Storage Cradle (Trays / Cutting Boards / Lids)	✓	✓	✓
Dome Drying and Storage Cradle	✓	✓	✓
Angled Drying and Storage Cradle	✓	✓	✓
Ultimate #10 Can Rack	✓	✓	
Shelf Divider Panel	✓	✓	✓
Shelf Divider Bar (for Food Pans or Food Boxes)	✓	✓	
Single Shelf Sheet Pan/Tray Rack	✓	✓	✓
Single Shelf Security Cage	✓	✓	✓
Full Wrap Security Cage	✓		



FREE CAMSHELVING® DESIGN SERVICE



Take the guesswork out of creating your perfect shelving layout. Let our expert shelving consultants prepare a free layout that optimizes your space to create the most storage options.

Here's what you'll get:

- 2D Floor Plan
- 3D Floor Plan
- Itemized product list by room/area
- All within 48 business-day hours

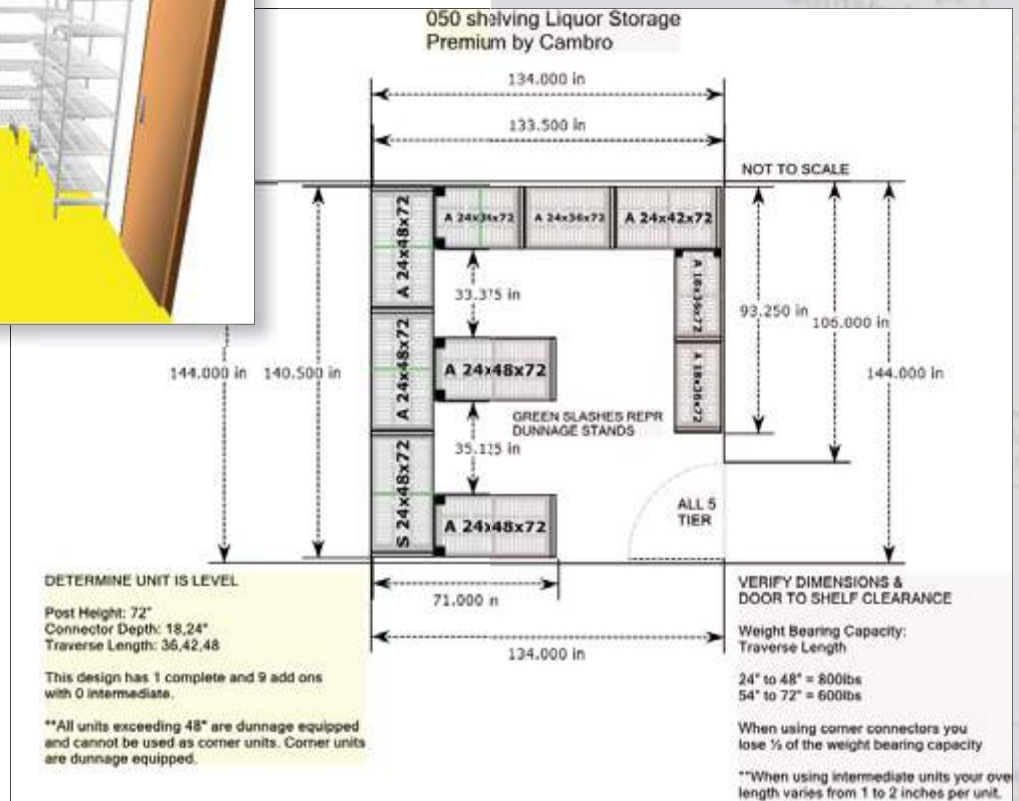

It's Simple! To Get Started, Please Provide:

- Project Name
- Storage Room Type (freezer / cooler)
- Room(s) Dimensions (L x W x H)
- Doorway / Entryway Location & Dimension
- Obstructions (condenser / pipes)
- Additional Preferences / Requirements

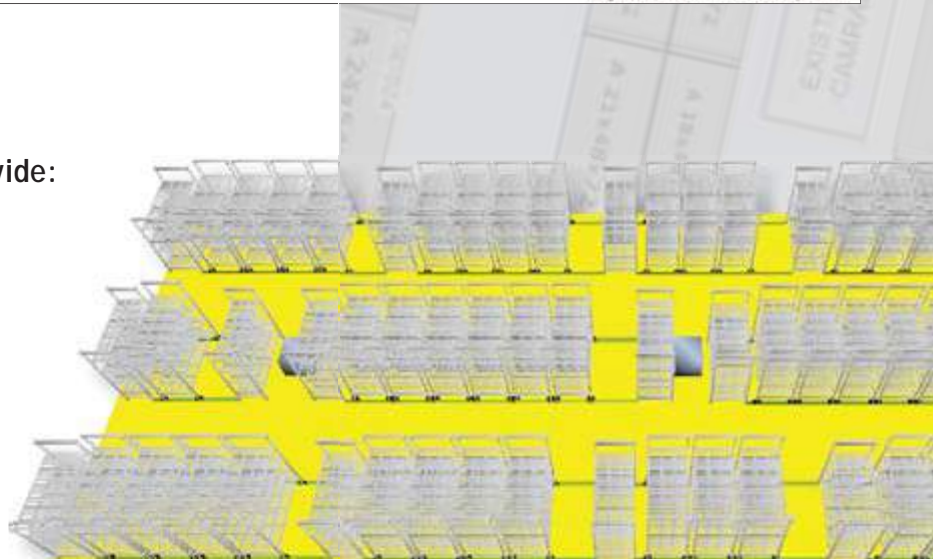

Request a Free
3D Shelving Layout

CAMSHELVING® SERIES OVERALL LENGTH – QUICK REFERENCE GUIDE

Straight Unit: Starter Unit + Add-On Unit with Shared Posts

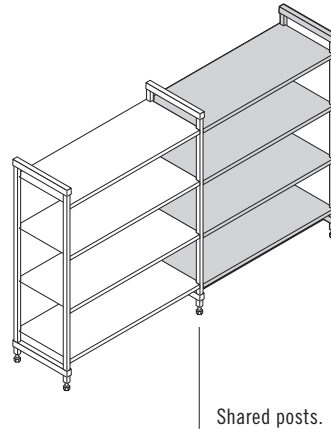
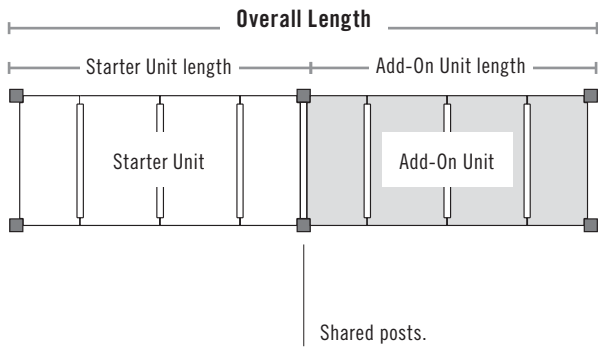

Corner Unit: Starter Unit + Add-On Unit with Corner Connectors

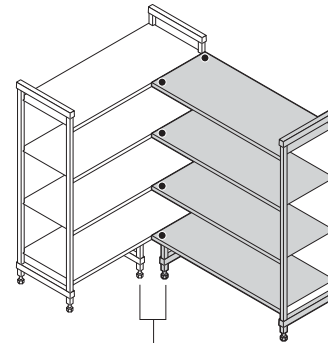
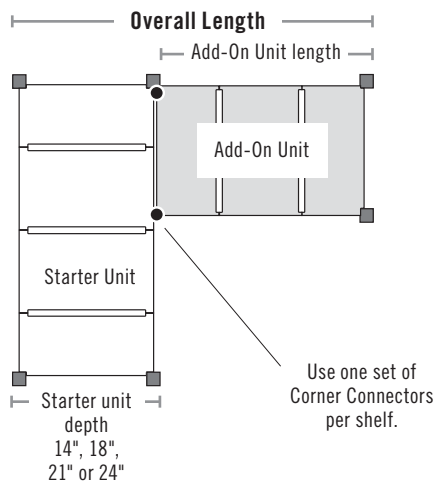

U-Shape Unit: Two Starter Units + Intermediate Shelves with Corner Connectors

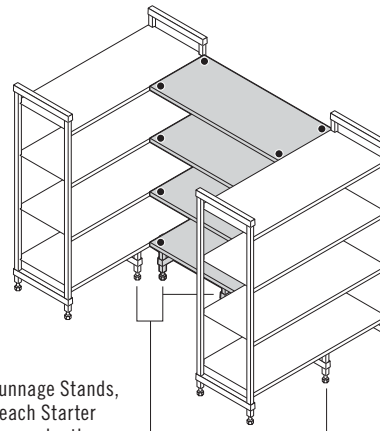
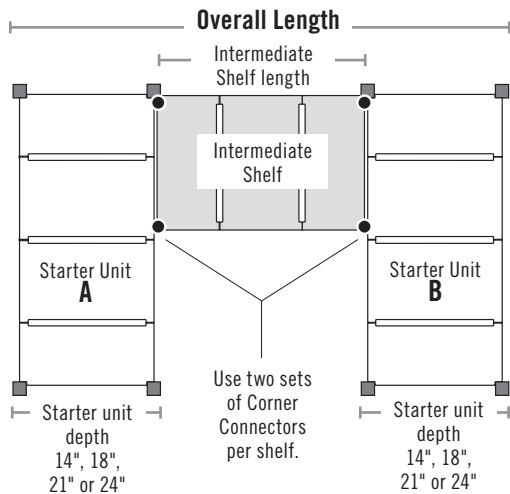

Number of Shelves Per Unit

STATIONARY POST HEIGHT	MOBILE POST HEIGHT	MAXIMUM SHELVES PER UNIT*
30"	—	5
—	27"	3
32"	35"	6
56"	59"	12
64"	67" or 70"	14
72"	75" or 78"	16
84"	—	19

*Based on 4" spacing.

Straight Unit: Starter Unit + Add-On Unit with Shared Posts

PREMIUM / BASICS PLUS SERIES				ELEMENTS SERIES			
STARTER UNIT ACTUAL LENGTH		ADD-ON UNIT ACTUAL LENGTH	OVERALL LENGTH	STARTER UNIT ACTUAL LENGTH		ADD-ON UNIT ACTUAL LENGTH	OVERALL LENGTH
24"	+	22¼"	= 46¼"	24"	+	22"	= 46"
30"	+	28¼"	= 58¼"	30"	+	28"	= 58"
36"	+	34¼"	= 70¼"	36"	+	34"	= 70"
42"	+	40¼"	= 82¼"	42"	+	40"	= 82"
48"	+	46¼"	= 94¼"	48"	+	46"	= 94"
54"	+	52¼"	= 106¼"	54"	+	52"	= 106"
60"	+	58¼"	= 118¼"	60"	+	58"	= 118"
72"	+	70¼"	= 142¼"	72"	+	70"	= 142"

24" and 72" are not available in Camshelving Basics Plus Series.

Corner Unit: Starter Unit + Add-On Unit with Corner Connectors

PREMIUM / ELEMENTS / BASICS PLUS SERIES				PREMIUM / ELEMENTS / BASICS PLUS SERIES				PREMIUM / ELEMENTS / BASICS PLUS SERIES			
ADD-ON UNIT	ADD-ON UNIT ACTUAL LENGTH	18" STARTER UNIT DEPTH	OVERALL LENGTH	ADD-ON UNIT ACTUAL LENGTH	21" STARTER UNIT DEPTH	OVERALL LENGTH	ADD-ON UNIT ACTUAL LENGTH	24" STARTER UNIT DEPTH	OVERALL LENGTH		
24"	23"	+ *18"	= 41"	23"	+ *21"	= 44"	23"	+ *24"	= 47"		
30"	29"	+ *18"	= 47"	29"	+ *21"	= 50"	29"	+ *24"	= 53"		
36"	35"	+ *18"	= 53"	35"	+ *21"	= 56"	35"	+ *24"	= 59"		
42"	41"	+ *18"	= 59"	41"	+ *21"	= 62"	41"	+ *24"	= 65"		
48"	47"	+ *18"	= 65"	47"	+ *21"	= 68"	47"	+ *24"	= 71"		

24" unit not available in Camshelving Basics Plus Series.

*Actual depth.

U-Shape Unit: Two Starter Units + Intermediate Shelves with Corner Connectors

PREMIUM / ELEMENTS / BASICS PLUS SERIES				PREMIUM / ELEMENTS / BASICS PLUS SERIES				PREMIUM / ELEMENTS / BASICS PLUS SERIES			
INTERMEDIATE SHELF	INTERMEDIATE SHELF ACTUAL LENGTH	18" DEPTH STARTER UNIT A+B	OVERALL LENGTH	INTERMEDIATE SHELF ACTUAL LENGTH	21" DEPTH STARTER UNIT A+B	OVERALL LENGTH	INTERMEDIATE SHELF ACTUAL LENGTH	24" DEPTH STARTER UNIT A+B	OVERALL LENGTH		
36"	34"	+ *36"	= 70"	34"	+ *42"	= 76"	34"	+ *48"	= 82"		
42"	40"	+ *36"	= 76"	40"	+ *42"	= 82"	40"	+ *48"	= 88"		
48"	46"	+ *36"	= 82"	46"	+ *42"	= 88"	46"	+ *48"	= 94"		

*Actual depth.

CAMSHELVING®

PREMIUM

series

STATIONARY | MOBILE | HIGH DENSITY

WHY CHOOSE PREMIUM?

In high volume foodservice operations with frequent deliveries and constant loading and off-loading of products, stability, strength and sanitary storage should never be compromised. Premium Series does precisely what it was designed to do – hold the heaviest products with the roughest handling, in any environment. It is also the easiest to clean and adjust.

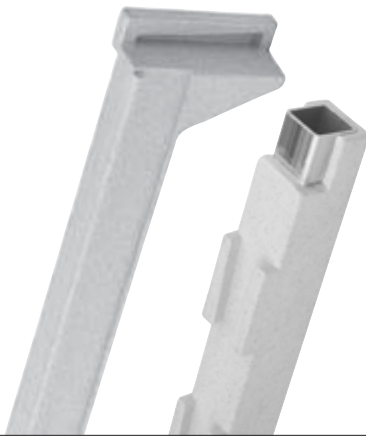

camguard
ANTIMICROBIAL SHELF PLATES



COMPONENT



Post Connectors, Corner Connectors, Floor Fastener, Wall Fastener, Identification Tags, Full Wrap Security Cage, Single Shelf Security Cage, Ultimate #10 Can Rack, Shelf Rails, Shelf Divider Bars, High Density Track and Extension Kits are not NSF Listed.

CAMSHELVING® PREMIUM SERIES

Stationary Unit Sizes

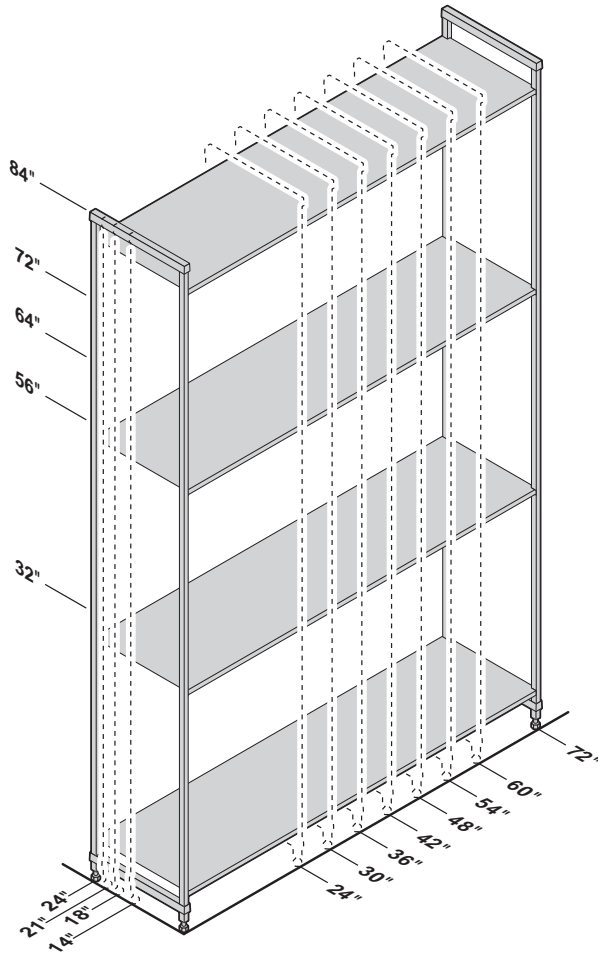

Mobile Unit Sizes

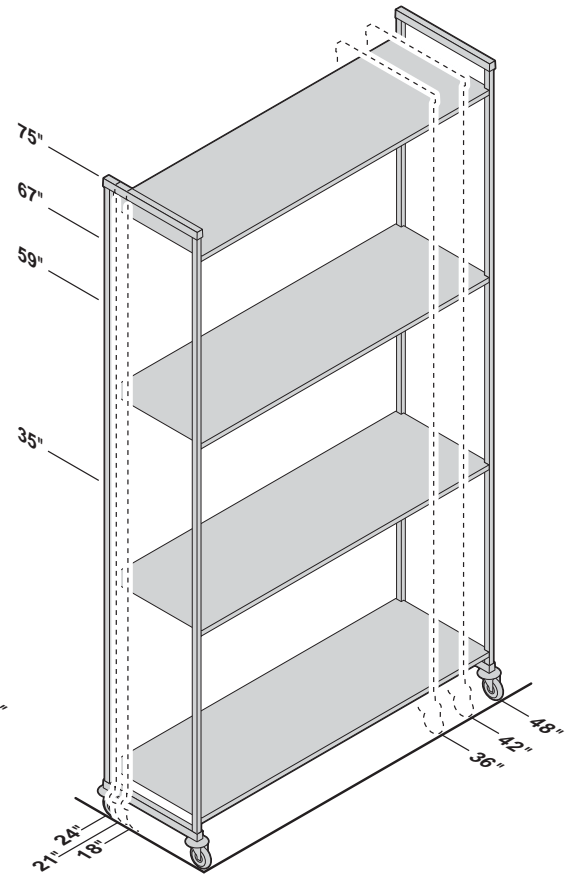

Weight Bearing Capacity

Weight must be evenly distributed across the entire shelf.

		UNIT LENGTH 24" – 48"	UNIT LENGTH 54" – 72"
SINGLE UNIT	Unit only	2000 lbs.	2000 lbs.
	Shelf only	800	600
	Unit with dunnage stand*	2400	2300
	Bottom shelf with dunnage stand*	1200	900
CORNER UNIT*** With 2 Dunnage Stands required	Unit only	1800	—
	Shelf only	400	—
	Bottom shelf with dunnage stands*	600	—
MOBILE UNIT	Unit only**	750	—

*Dunnage Stands add stability and increase weight bearing capacity on bottom shelf only. Highly recommended for Starter Units 54" and longer, all Corner Units, U-Shape Units and units specified for heavier loads. (See Overall Length Quick Reference Guide).

**Due to the weight bearing capacity of casters, maximum weight load on an entire Mobile Unit is 750 lbs.

*** Corner connectors are for use only with shelves 24" - 48" long.



CAMSHELVING® PREMIUM SERIES – STARTER, ADD-ON AND MOBILE UNITS

V4 4-Shelf Vented Stationary Starter and Add-On Units

HEIGHTS	DEPTHS	LENGTHS	
3	3	8	
64"	18"	24"	48"
72"	21"	30"	54"
84"	24"	36"	60"
		42"	72"

V5 5-Shelf Vented Stationary Starter and Add-On Units

HEIGHTS	DEPTHS	LENGTHS	
3	3	8	
64"	18"	24"	48"
72"	21"	30"	54"
84"	24"	36"	60"
		42"	72"

S4 4-Shelf Solid Stationary Starter and Add-On Units

HEIGHTS	DEPTHS	LENGTHS	
3	3	8	
64"	18"	24"	48"
72"	21"	30"	54"
84"	24"	36"	60"
		42"	72"

S5 5-Shelf Solid Stationary Starter and Add-On Units

HEIGHT	DEPTHS	LENGTHS	
1	3	8	
84"	18"	24"	48"
	21"	30"	54"
	24"	36"	60"
		42"	72"

VS4 4-Shelf Vented and Solid Stationary Starter and Add-On Units (3 vented + 1 solid)

HEIGHTS	DEPTHS	LENGTHS	
3	3	8	
64"	18"	24"	48"
72"	21"	30"	54"
84"	24"	36"	60"
		42"	72"

VS5 5-Shelf Vented and Solid Stationary Starter and Add-On Units (4 vented + 1 solid)

HEIGHT	DEPTHS	LENGTHS	
1	3	8	
84"	18"	24"	48"
	21"	30"	54"
	24"	36"	60"
		42"	72"

V4 4-Shelf Vented Mobile Starter Units

HEIGHTS*	DEPTHS	LENGTHS	
2	3	3	
67"	18"	36"	
75"	21"	42"	
	24"	48"	

V5 5-Shelf Vented Mobile Starter Units

HEIGHTS*	DEPTHS	LENGTHS	
2	3	3	
67"	18"	36"	
75"	21"	42"	
	24"	48"	

* Includes 5" casters.



Visit the Camshelving® website at www.cambro.com/camshelving for product information, assembly videos and design layouts, or to view or download the Camshelving Specification and Price List.

PREMIUM
SERIES

V4 4-SHELF VENTED UNITS

64"
HEIGHT

Starter units include 2 factory assembled post kits and shelves. Add-on units include 1 factory assembled post kit and shelves. Units ship complete in 1 box.

Starter

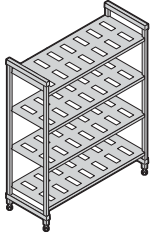

Add-On

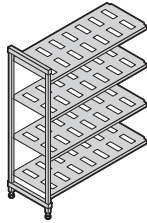

18"
DEPTH

DIMENSIONS D x L x H	CODE	LIST PRICE EA.	CODE	LIST PRICE EA.
18" x 24" x 64"	CPU182464V4	\$ 512.60	CPA182464V4	\$ 397.40
18" x 30" x 64"	CPU183064V4	579.60	CPA183064V4	464.40
18" x 36" x 64"	CPU183664V4	617.00	CPA183664V4	501.80
18" x 42" x 64"	CPU184264V4	692.00	CPA184264V4	576.80
18" x 48" x 64"	CPU184864V4	719.00	CPA184864V4	603.80
18" x 54" x 64"	CPU185464V4	793.40	CPA185464V4	678.20
18" x 60" x 64"	CPU186064V4	844.40	CPA186064V4	729.20
18" x 72" x 64"	CPU187264V4PKG	944.20	CPA187264V4PKG	829.00

PKG units ship same as 84" units.

21"
DEPTH

21" x 24" x 64"	CPU212464V4	\$ 552.60	CPA212464V4	\$ 434.40
21" x 30" x 64"	CPU213064V4	628.40	CPA213064V4	510.20
21" x 36" x 64"	CPU213664V4	673.20	CPA213664V4	555.00
21" x 42" x 64"	CPU214264V4	758.40	CPA214264V4	640.20
21" x 48" x 64"	CPU214864V4	790.60	CPA214864V4	672.40
21" x 54" x 64"	CPU215464V4	875.40	CPA215464V4	757.20
21" x 60" x 64"	CPU216064V4	933.60	CPA216064V4	815.40
21" x 72" x 64"	CPU217264V4PKG	1,049.40	CPA217264V4PKG	931.20

PKG units ship same as 84" units.

24"
DEPTH

24" x 24" x 64"	CPU242464V4	\$ 561.60	CPA242464V4	\$ 442.60
24" x 30" x 64"	CPU243064V4	640.80	CPA243064V4	521.80
24" x 36" x 64"	CPU243664V4	691.20	CPA243664V4	572.20
24" x 42" x 64"	CPU244264V4	766.80	CPA244264V4	647.80
24" x 48" x 64"	CPU244864V4	817.00	CPA244864V4	698.00
24" x 54" x 64"	CPU245464V4	887.80	CPA245464V4	768.80
24" x 60" x 64"	CPU246064V4	940.00	CPA246064V4	821.00
24" x 72" x 64"	CPU247264V4PKG	1,064.80	CPA247264V4PKG	945.80

PKG units ship same as 84" units.

PREMIUM
SERIES

V4 4-SHELF VENTED UNITS

72"
HEIGHT

Starter units include 2 factory assembled post kits and shelves. Add-on units include 1 factory assembled post kit and shelves. Units ship complete in 1 box.

Starter

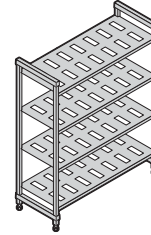

Add-On

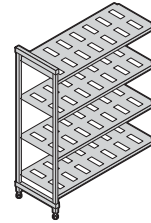

DIMENSIONS D x L x H	CODE	LIST PRICE EA.	CODE	LIST PRICE EA.
18" x 24" x 72"	CPU182472V4	\$ 517.70	CPA182472V4	\$ 399.95
18" x 30" x 72"	CPU183072V4	584.70	CPA183072V4	466.95
18" x 36" x 72"	CPU183672V4	622.10	CPA183672V4	504.35
18" x 42" x 72"	CPU184272V4	697.10	CPA184272V4	579.35
18" x 48" x 72"	CPU184872V4	724.10	CPA184872V4	606.35
18" x 54" x 72"	CPU185472V4	798.50	CPA185472V4	680.75
18" x 60" x 72"	CPU186072V4	849.50	CPA186072V4	731.75
18" x 72" x 72"	CPU187272V4PKG	949.30	CPA187272V4PKG	831.55

21" x 24" x 72"	CPU212472V4	\$ 557.30	CPA212472V4	\$ 436.75
21" x 30" x 72"	CPU213072V4	633.10	CPA213072V4	512.55
21" x 36" x 72"	CPU213672V4	677.90	CPA213672V4	557.35
21" x 42" x 72"	CPU214272V4	763.10	CPA214272V4	642.55
21" x 48" x 72"	CPU214872V4	795.30	CPA214872V4	674.75
21" x 54" x 72"	CPU215472V4	880.10	CPA215472V4	759.55
21" x 60" x 72"	CPU216072V4	938.30	CPA216072V4	817.75
21" x 72" x 72"	CPU217272V4PKG	1,054.10	CPA217272V4PKG	933.55

24" x 24" x 72"	CPU242472V4	\$ 567.00	CPA242472V4	\$ 445.30
24" x 30" x 72"	CPU243072V4	646.20	CPA243072V4	524.50
24" x 36" x 72"	CPU243672V4	696.60	CPA243672V4	574.90
24" x 42" x 72"	CPU244272V4	772.20	CPA244272V4	650.50
24" x 48" x 72"	CPU244872V4	822.40	CPA244872V4	700.70
24" x 54" x 72"	CPU245472V4	893.20	CPA245472V4	771.50
24" x 60" x 72"	CPU246072V4	945.40	CPA246072V4	823.70
24" x 72" x 72"	CPU247272V4PKG	1,070.20	CPA247272V4PKG	948.50

Color: Speckled Gray (480).

PREMIUM
SERIES

V5PKG 5-SHELF VENTED UNITS

84"
HEIGHT

Due to the unit weight, 84" units ship in separate boxes. Starter units include 2 post kits and 1 box of shelves. Add on units include 1 post kit and 1 box of shelves. Post kits require assembly.

Starter

Add-On

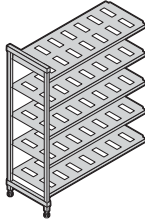
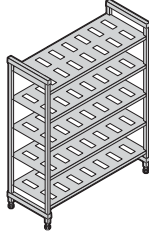

18"
DEPTH

DIMENSIONS D x L x H	CODE	LIST PRICE EA.	CODE	LIST PRICE EA.
18" x 24" x 84"	CPU182484V5PKG	\$ 624.85	CPA182484V5PKG	\$ 488.80
18" x 30" x 84"	CPU183084V5PKG	708.60	CPA183084V5PKG	572.55
18" x 36" x 84"	CPU183684V5PKG	755.35	CPA183684V5PKG	619.30
18" x 42" x 84"	CPU184284V5PKG	849.10	CPA184284V5PKG	713.05
18" x 48" x 84"	CPU184884V5PKG	882.85	CPA184884V5PKG	746.80
18" x 54" x 84"	CPU185484V5PKG	975.85	CPA185484V5PKG	839.80
18" x 60" x 84"	CPU186084V5PKG	1,039.60	CPA186084V5PKG	903.55
18" x 72" x 84"	CPU187284V5PKG	1,164.35	CPA187284V5PKG	1,028.30

21"
DEPTH

21" x 24" x 84"	CPU212484V5PKG	\$ 672.95	CPA212484V5PKG	\$ 534.10
21" x 30" x 84"	CPU213084V5PKG	767.70	CPA213084V5PKG	628.85
21" x 36" x 84"	CPU213684V5PKG	823.70	CPA213684V5PKG	684.85
21" x 42" x 84"	CPU214284V5PKG	930.20	CPA214284V5PKG	791.35
21" x 48" x 84"	CPU214884V5PKG	970.45	CPA214884V5PKG	831.60
21" x 54" x 84"	CPU215484V5PKG	1,076.45	CPA215484V5PKG	937.60
21" x 60" x 84"	CPU216084V5PKG	1,149.20	CPA216084V5PKG	1,010.35
21" x 72" x 84"	CPU217284V5PKG	1,293.95	CPA217284V5PKG	1,155.50

24"
DEPTH

24" x 24" x 84"	CPU242484V5PKG	\$ 684.40	CPA242484V5PKG	\$ 544.45
24" x 30" x 84"	CPU243084V5PKG	783.40	CPA243084V5PKG	643.45
24" x 36" x 84"	CPU243684V5PKG	846.40	CPA243684V5PKG	706.45
24" x 42" x 84"	CPU244284V5PKG	940.90	CPA244284V5PKG	800.95
24" x 48" x 84"	CPU244884V5PKG	1,003.65	CPA244884V5PKG	863.70
24" x 54" x 84"	CPU245484V5PKG	1,092.15	CPA245484V5PKG	952.20
24" x 60" x 84"	CPU246084V5PKG	1,157.40	CPA246084V5PKG	1,017.45
24" x 72" x 84"	CPU247284V5PKG	1,313.40	CPA247284V5PKG	1,173.45

Color: Speckled Gray (480).

1.800.833.3003

PREMIUM
SERIES

V4 4-SHELF VENTED MOBILE UNITS

Mobile starter units include 2 factory assembled mobile post kits, shelves and 4 premium swivel casters with total locking brake. Units ship complete in 1 box.

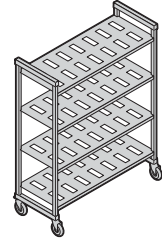

67"
HEIGHT

18"
DEPTH

CODE	DIMENSIONS D x L x H*	LIST PRICE EA.
CPMU183667V4	18" x 36" x 67"	\$ 914.90
CPMU184267V4	18" x 42" x 67"	989.90
CPMU184867V4	18" x 48" x 67"	1,016.90

21"
DEPTH

CPMU213667V4	21" x 36" x 67"	\$ 970.80
CPMU214267V4	21" x 42" x 67"	1,056.00
CPMU214867V4	21" x 48" x 67"	1,088.20

24"
DEPTH

CPMU243667V4	24" x 36" x 67"	\$ 988.90
CPMU244267V4	24" x 42" x 67"	1,064.50
CPMU244867V4	24" x 48" x 67"	1,114.70

75"
HEIGHT

18"
DEPTH

CODE	DIMENSIONS D x L x H*	LIST PRICE EA.
CPMU183675V4	18" x 36" x 75"	\$ 919.90
CPMU184275V4	18" x 42" x 75"	994.90
CPMU184875V4	18" x 48" x 75"	1,021.90

21"
DEPTH

CPMU213675V4	21" x 36" x 75"	\$ 975.90
CPMU214275V4	21" x 42" x 75"	1,061.10
CPMU214875V4	21" x 48" x 75"	1,093.30

24"
DEPTH

CPMU243675V4	24" x 36" x 75"	\$ 994.30
CPMU244275V4	24" x 42" x 75"	1069.90
CPMU244875V4	24" x 48" x 75"	1120.10

*Includes 5" casters.

CAMBRO USA-SHELVING

107

CAMSHELVING® PREMIUM SERIES

Corner Connectors

Unique patented design ensures maximum shelf space utilization. Use 1 set per shelf to connect starter and add-on units in corners. Connect 4 or 5 intermediate shelves between 2 starter units (2 sets required per shelf). Available as a single set or 8 or 10 set packs.

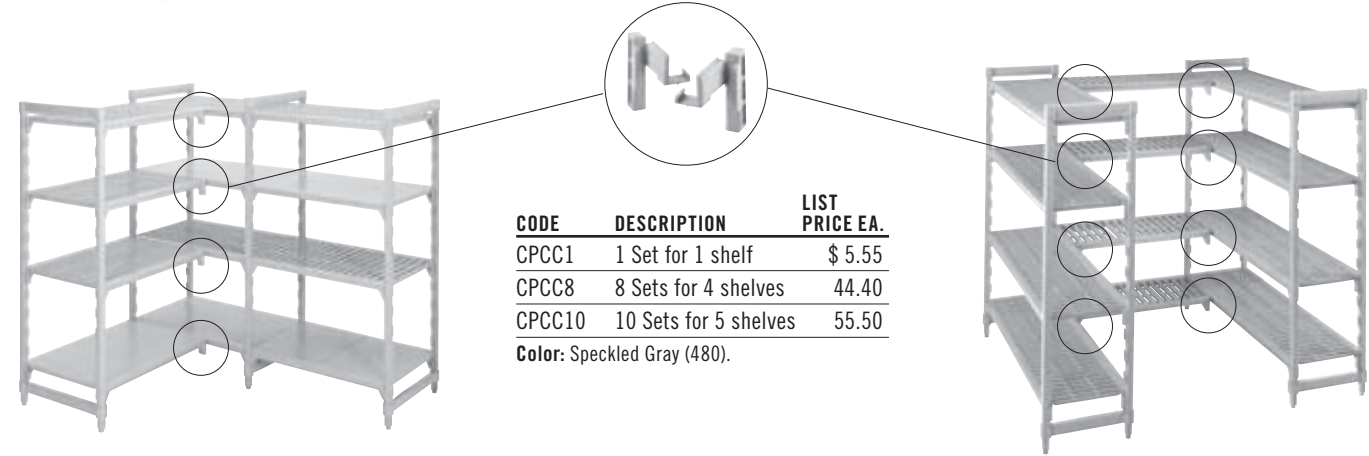

CODE	DESCRIPTION	LIST PRICE EA.
CPCC1	1 Set for 1 shelf	\$ 5.55
CPCC8	8 Sets for 4 shelves	44.40
CPCC10	10 Sets for 5 shelves	55.50

Color: Speckled Gray (480).

Bottom Shelf Dunnage Stands

Increase weight bearing capacity on bottom shelf only. Add to any shelf length. Highly recommended for starter units 54" and longer and all corner units, intermediate units and units specified for heavier load volume on and off bottom shelves.

CODE	DIMENSIONS D x H	LIST PRICE EA.
Dunnage Stand - Low		
CPDS14H6	14" x 7½"	\$ 73.25
CPDS18H6	18" x 7½"	75.65
CPDS21H6	21" x 7½"	77.55
CPDS24H6	24" x 7½"	79.50
Dunnage Stand - Tall		
CPDS14H11	14" x 11¾"	79.30
CPDS18H11	18" x 11¾"	81.75
CPDS21H11	21" x 11¾"	83.65
CPDS24H11	24" x 11¾"	85.60

Case Pack: 1 **Color:** Speckled Gray (480).

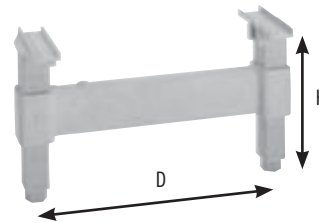

Shelf Traverses

Available in single or double packs. Use a single set to add an open shelf for divider bars or drying racks. Add single traverses onto back posts for extra support when placing rolling equipment under the first shelf.

LENGTH	SINGLE PACK CODE*	LIST PRICE EA.	DOUBLE PACK CODE**	LIST PRICE EA.
24"	CPTR24	\$ 32.30	CPTR242PK	\$ 56.50
30"	CPTR30	34.90	CPTR302PK	61.20
36"	CPTR36	38.00	CPTR362PK	66.50
42"	CPTR42	40.60	CPTR422PK	72.50
48"	CPTR48	44.30	CPTR482PK	79.10
54"	CPTR54	48.10	CPTR542PK	85.80
60"	CPTR60	51.80	CPTR602PK	92.50
72"	CPTR72	56.50	—	—

*Case Pack: 1 **Case Pack: 2 **Color:** Speckled Gray (480).



HIGH DENSITY STORAGE FLOOR TRACK SYSTEM

Maximize storage capacity by creating storage aisles in all available space. This simple system is composed of stationary starter units anchored to a raised floor track system at both ends with high density mobile units installed in between. Easy to install track requires no drilling or gluing.



Increases Storage Capacity Up To

50%

High Density Mobile Units are available with factory assembled post kits, vented or solid shelves and high density casters and bumpers. Full track and extension kits ship complete with required hardware. Stationary Starter Units are required to anchor the system at both ends. Choose from a wide selection of sizes with 4 or 5 shelves to maximize storage space. (see Premium Series spec pages).

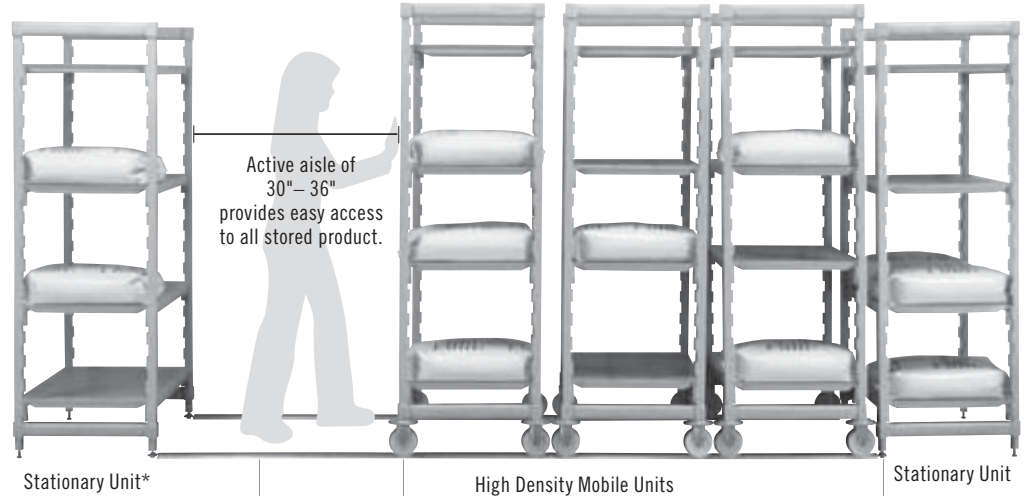

Raised Floor Track provides a smooth and level surface to easily roll mobile units. Raised track ensures dirt will not get trapped and is easy to clean. Aluminum track and stainless steel hardware are rust resistant.



Grooved casters roll easily and securely on raised track.



Raised track connects easily to the bottom of a stationary unit that works as a system anchor. No bolts, no glue or drilling into the floor are required. Easy and fast set up.

*It is recommended to use a stationary unit for every 15' of track to further stabilize the system.

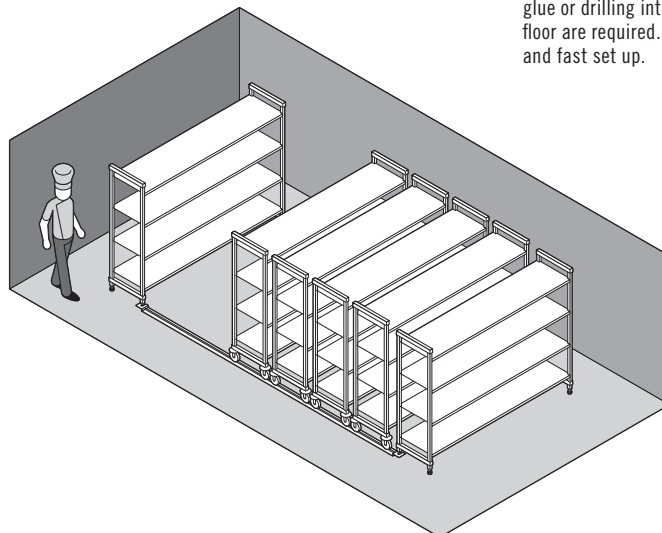
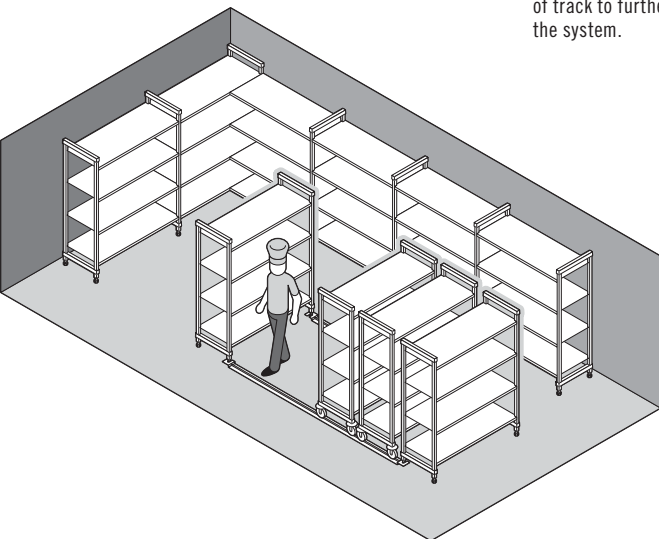

V4

4-SHELF VENTED HIGH DENSITY MOBILE UNITS

Units include 2 factory assembled mobile post kits, 4 shelves, 4 high density casters and 4 high density bumpers. Units ship complete in 1 box.

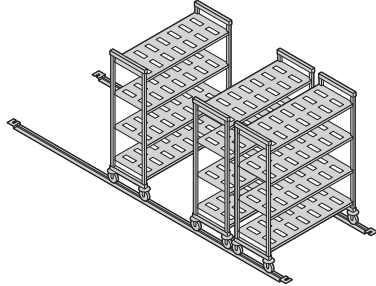

67"
HEIGHT

21"
DEPTH

24"
DEPTH

75"
HEIGHT

21"
DEPTH

24"
DEPTH

CODE	DIMENSIONS D x L x H*	LIST PRICE EA.
CPHU213667V4	21" x 36" x 67"	\$ 992.50
CPHU214267V4	21" x 42" x 67"	1,077.70
CPHU214867V4	21" x 48" x 67"	1,109.90
CPHU215467V4	21" x 54" x 67"	1,194.70
CPHU216067V4	21" x 60" x 67"	1,252.90

CPHU243667V4	24" x 36" x 67"	\$ 1,010.70
CPHU244267V4	24" x 42" x 67"	1,086.30
CPHU244867V4	24" x 48" x 67"	1,136.50
CPHU245467V4	24" x 54" x 67"	1,207.30
CPHU246067V4	24" x 60" x 67"	1,259.50

CODE	DIMENSIONS D x L x H*	LIST PRICE EA.
CPHU213675V4	21" x 36" x 75"	\$ 997.70
CPHU214275V4	21" x 42" x 75"	1,082.90
CPHU214875V4	21" x 48" x 75"	1,115.10
CPHU215475V4	21" x 54" x 75"	1,199.90
CPHU216075V4	21" x 60" x 75"	1,258.10

CPHU243675V4	24" x 36" x 75"	\$ 1,016.00
CPHU244275V4	24" x 42" x 75"	1,091.60
CPHU244875V4	24" x 48" x 75"	1,141.80
CPHU245475V4	24" x 54" x 75"	1,212.60
CPHU246075V4	24" x 60" x 75"	1,264.80

S4

4-SHELF SOLID HIGH DENSITY MOBILE UNITS

Units include 2 factory assembled mobile post kits, 4 shelves, 4 high density casters and 4 high density bumpers. Units ship complete in 1 box.

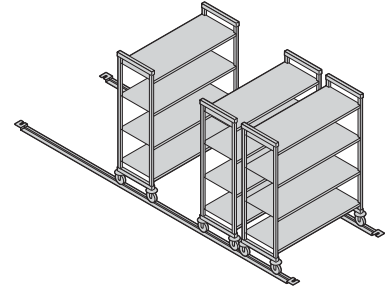

CODE	DIMENSIONS D x L x H*	LIST PRICE EA.
CPHU213667S4	21" x 36" x 67"	\$ 1,016.10
CPHU214267S4	21" x 42" x 67"	1,103.10
CPHU214867S4	21" x 48" x 67"	1,144.50
CPHU215467S4	21" x 54" x 67"	1,230.70
CPHU216067S4	21" x 60" x 67"	1,290.70

CPHU243667S4	24" x 36" x 67"	\$ 1,043.50
CPHU244267S4	24" x 42" x 67"	1,120.10
CPHU244867S4	24" x 48" x 67"	1,174.10
CPHU245467S4	24" x 54" x 67"	1,251.50
CPHU246067S4	24" x 60" x 67"	1,310.10

CODE	DIMENSIONS D x L x H*	LIST PRICE EA.
CPHU213675S4	21" x 36" x 75"	\$ 1,021.30
CPHU214275S4	21" x 42" x 75"	1,108.30
CPHU214875S4	21" x 48" x 75"	1,149.70
CPHU215475S4	21" x 54" x 75"	1,235.90
CPHU216075S4	21" x 60" x 75"	1,295.90

CPHU243675S4	24" x 36" x 75"	\$ 1,048.80
CPHU244275S4	24" x 42" x 75"	1,125.40
CPHU244875S4	24" x 48" x 75"	1,179.40
CPHU245475S4	24" x 54" x 75"	1,256.80
CPHU246075S4	24" x 60" x 75"	1,315.40

Full Track and Extension Kits

Aluminum raised track kits and track extensions ship complete in 1 box. Each kit includes all stainless steel hardware necessary to complete a floor installation.

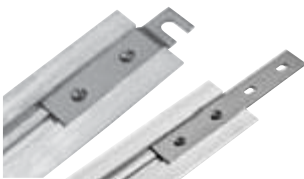
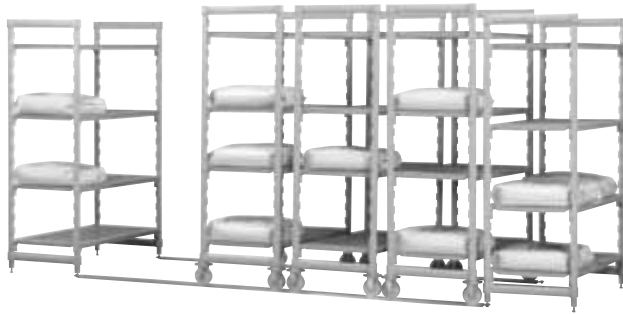

It is highly recommended to install a stationary starter unit every 15' of track to further stabilize the system.

CODE	DESCRIPTION	CASE PACK	LIST PRICE EA.
Full Track Kit			
CSMHDTK10	10' Track for 3 Mobile Units*	1	\$ 638.60
CSMHDTK12	12' Track for 4 Mobile Units*	1	736.45
CSMHDTK145	14.5' Track for 5 Mobile Units*	1	829.15
Track Extension Kit			
CSMHDTKE4	4.5' Track Extension	1	240.90
CSMHDTKE5	5' Track Extension	1	257.25
CSMHDTKE6	6' Track Extension	1	305.40

Color: Silver (000). *Based on 24" deep mobile units.

High Density Caster with Donut Bumper



CODE	SIZE	LIST PRICE EA.
CPMCHD	5"	\$ 55.55
Case Pack: 2		Color: Gray (000).



CAMSHELVING®

ELEMENTS

series

STATIONARY | MOBILE | UNDERCOUNTER

WHY CHOOSE ELEMENTS?

Made from a revolutionary, extremely strong composite material with a smooth, easy to clean surface. Elements Series is stronger than common wire shelving. It's lighter in weight than Camshelving Premium Series and totally impervious to moisture, chemicals and liquids that can destroy shelving over time. Elements Series is designed for medium to heavy storage use in freezers, coolers, dry storage or warewashing areas. It easily supports the performance demands of a busy foodservice operation.



camguard
ANTIMICROBIAL SHELF PLATES



StoreSafe
STORE FRESH

Post Connectors, Corner Connectors, Floor Fastener, Wall Fastener, Identification Tags, Single Shelf Security Cage, Ultimate #10 Can Rack, and Shelf Divider Bars are not NSF Listed.

CAMSHELVING® ELEMENTS SERIES

Stationary Unit Sizes

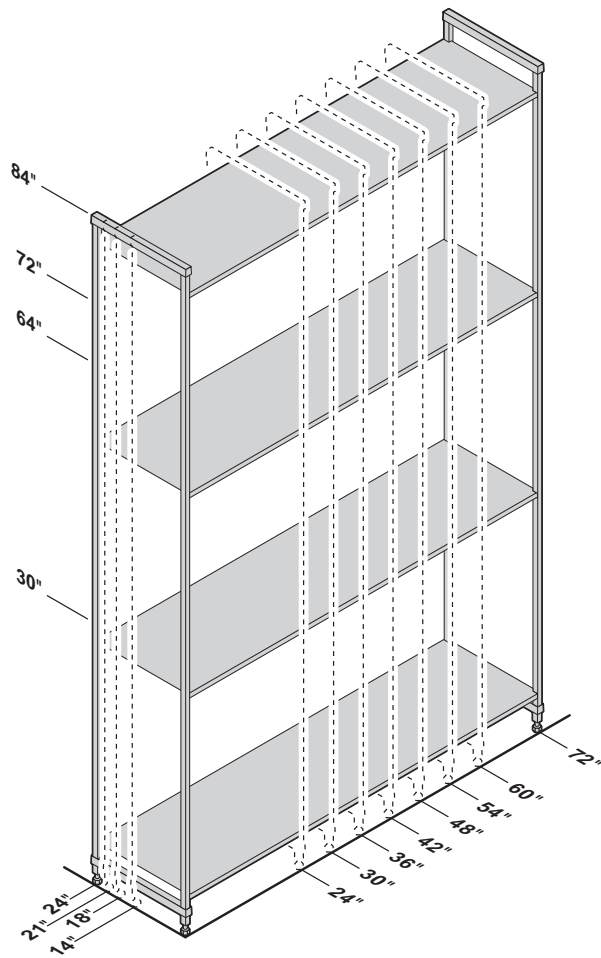

Mobile Unit Sizes

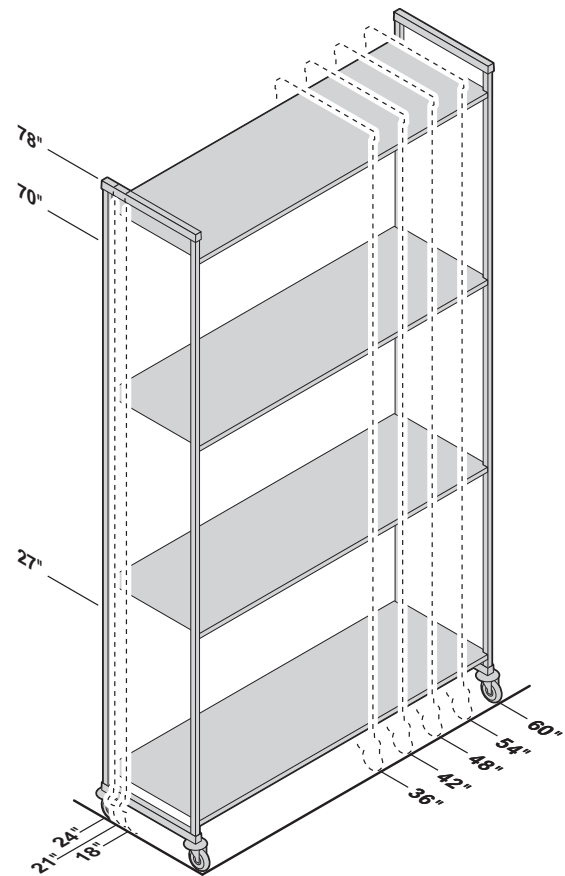

Weight Bearing Capacity

Weight must be evenly distributed across the entire shelf.

		UNIT LENGTH 24" – 48"	UNIT LENGTH 54" – 72"
SINGLE UNIT	Unit only	2000 lbs.	2000 lbs.
	Shelf only	800	600
	Unit with dunnage stand*	2400	2300
	Bottom shelf with dunnage stand*	1200	900
CORNER UNIT*** With 2 Dunnage Stands required	Unit only	1800	—
	Shelf only	400	—
	Bottom shelf with dunnage stands*	600	—
MOBILE UNIT	Unit only**	750	—

*Dunnage Stands add stability and increase weight bearing capacity on bottom shelf only. Highly recommended for Starter Units 54" and longer, all Corner Units, U-Shape Units and units specified for heavier loads. (See Overall Length Quick Reference Guide).

**Due to the weight bearing capacity of casters, maximum weight load on an entire Mobile Unit is 750 lbs.

*** Corner connectors are for use only with shelves 24" - 48" long.

CAMSHELVING® ELEMENTS SERIES – STARTER, ADD-ON AND MOBILE UNITS

V4 V5 4-Shelf or 5-Shelf Vented Stationary Starter and Add-On Units

HEIGHTS	DEPTHS	LENGTHS	
3	3	8	
64"	18"	24"	48"
72"	21"	30"	54"
84"	24"	36"	60"
		42"	72"

V2 2-Shelf Undercounter Vented Stationary Starter Units

HEIGHT	DEPTH	LENGTHS
1	1	2
30"	18"	36"
		48"

S4 4-Shelf Solid Stationary Starter and Add-On Units

HEIGHTS	DEPTHS	LENGTHS	
3	3	8	
64"	18"	24"	48"
72"	21"	30"	54"
84"	24"	36"	60"
		42"	72"

S5 5-Shelf Solid Stationary Starter and Add-On Units

HEIGHT	DEPTHS	LENGTHS
1	3	8
84"	18"	24" 48"
	21"	30" 54"
	24"	36" 60"
		42" 72"

VS4 4-Shelf Vented and Solid Stationary Starter and Add-On Units (3 vented + 1 solid)

HEIGHTS	DEPTHS	LENGTHS	
3	3	8	
64"	18"	24"	48"
72"	21"	30"	54"
84"	24"	36"	60"
		42"	72"

VS5 5-Shelf Vented and Solid Stationary Starter and Add-On Units (4 vented + 1 solid)

HEIGHT	DEPTHS	LENGTHS
1	3	8
84"	18"	24" 48"
	21"	30" 54"
	24"	36" 60"
		42" 72"

V4 V5 4-Shelf or 5-Shelf Vented Mobile Starter Units

HEIGHTS*	DEPTHS	LENGTHS	
2	3	5	
70"	18"	36"	54"
78"	21"	42"	60"
	24"	48"	

V2 2-Shelf Undercounter Vented Mobile Starter Units

HEIGHT*	DEPTH	LENGTHS
1	1	3
27"	14"	24"
		36"
		48"

* Includes 5" casters.



Visit the Camshelving® website at www.cambro.com/camshelving for product information, assembly videos and design layouts, or to view or download the Camshelving Specification and Price List.



V4

4-SHELF VENTED UNITS

64"
HEIGHT

Starter units include 2 factory assembled stationary post kits, stationary traverses, stationary traverse dovetails and shelf plates. Add-On units include 1 factory assembled stationary post kit, stationary traverses, stationary traverse dovetails and shelf plates. Units ship complete in 1 box.

Starter

Add-On

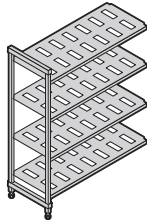
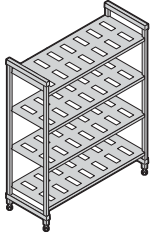

18"
DEPTH

DIMENSIONS D x L x H	CODE	LIST PRICE EA.
18" x 24" x 64"	ESU182464V4	\$ 416.90
18" x 30" x 64"	ESU183064V4	429.90
18" x 36" x 64"	ESU183664V4	472.70
18" x 42" x 64"	ESU184264V4	530.70
18" x 48" x 64"	ESU184864V4	551.50
18" x 54" x 64"	ESU185464V4	609.10
18" x 60" x 64"	ESU186064V4	648.70
18" x 72" x 64"	ESU187264V4	725.90

CODE	LIST PRICE EA.
ESU182464V4	\$ 416.90
ESU183064V4	429.90
ESU183664V4	472.70
ESU184264V4	530.70
ESU184864V4	551.50
ESU185464V4	609.10
ESU186064V4	648.70
ESU187264V4	725.90

CODE	LIST PRICE EA.
EA182464V4	\$ 330.25
EA183064V4	343.25
EA183664V4	386.05
EA184264V4	444.05
EA184864V4	464.85
EA185464V4	522.45
EA186064V4	562.05
EA187264V4	639.25

21"
DEPTH

21" x 24" x 64"	ESU212464V4	\$ 450.20
21" x 30" x 64"	ESU213064V4	466.60
21" x 36" x 64"	ESU213664V4	516.00
21" x 42" x 64"	ESU214264V4	581.60
21" x 48" x 64"	ESU214864V4	606.60
21" x 54" x 64"	ESU215464V4	672.40
21" x 60" x 64"	ESU216064V4	717.60
21" x 72" x 64"	ESU217264V4	807.40

ESU212464V4	\$ 450.20
ESU213064V4	466.60
ESU213664V4	516.00
ESU214264V4	581.60
ESU214864V4	606.60
ESU215464V4	672.40
ESU216064V4	717.60
ESU217264V4	807.40

EA212464V4	\$ 361.30
EA213064V4	377.70
EA213664V4	427.10
EA214264V4	492.70
EA214864V4	517.70
EA215464V4	583.50
EA216064V4	628.70
EA217264V4	718.50

24"
DEPTH

24" x 24" x 64"	ESU242464V4	\$ 461.40
24" x 30" x 64"	ESU243064V4	487.00
24" x 36" x 64"	ESU243664V4	530.00
24" x 42" x 64"	ESU244264V4	588.80
24" x 48" x 64"	ESU244864V4	627.20
24" x 54" x 64"	ESU245464V4	682.00
24" x 60" x 64"	ESU246064V4	722.80
24" x 72" x 64"	ESU247264V4	819.20

ESU242464V4	\$ 461.40
ESU243064V4	487.00
ESU243664V4	530.00
ESU244264V4	588.80
ESU244864V4	627.20
ESU245464V4	682.00
ESU246064V4	722.80
ESU247264V4	819.20

EA242464V4	\$ 371.80
EA243064V4	397.40
EA243664V4	440.40
EA244264V4	499.20
EA244864V4	537.60
EA245464V4	592.40
EA246064V4	633.20
EA247264V4	729.60

V4

4-SHELF VENTED UNITS

72"
HEIGHT

Starter units include 2 factory assembled stationary post kits, stationary traverses, stationary traverse dovetails and shelf plates. Add-On units include 1 factory assembled stationary post kit, stationary traverses, stationary traverse dovetails and shelf plates. Units ship complete in 1 box.

Starter

Add-On

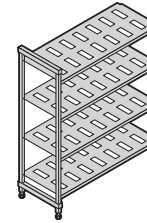
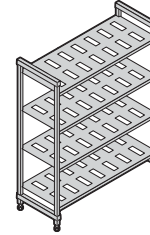

DIMENSIONS D x L x H	CODE	LIST PRICE EA.
18" x 24" x 72"	ESU182472V4	\$ 420.90
18" x 30" x 72"	ESU183072V4	433.90
18" x 36" x 72"	ESU183672V4	476.70
18" x 42" x 72"	ESU184272V4	534.70
18" x 48" x 72"	ESU184872V4	555.50
18" x 54" x 72"	ESU185472V4	613.10
18" x 60" x 72"	ESU186072V4	652.70
18" x 72" x 72"	ESU187272V4	729.90

CODE	LIST PRICE EA.
ESU182472V4	\$ 420.90
ESU183072V4	433.90
ESU183672V4	476.70
ESU184272V4	534.70
ESU184872V4	555.50
ESU185472V4	613.10
ESU186072V4	652.70
ESU187272V4	729.90

CODE	LIST PRICE EA.
EA182472V4	\$ 332.25
EA183072V4	345.25
EA183672V4	388.05
EA184272V4	446.05
EA184872V4	466.85
EA185472V4	524.45
EA186072V4	564.05
EA187272V4	641.25

21" x 24" x 72"	ESU212472V4	\$ 454.00
21" x 30" x 72"	ESU213072V4	470.40
21" x 36" x 72"	ESU213672V4	519.80
21" x 42" x 72"	ESU214272V4	585.40
21" x 48" x 72"	ESU214872V4	610.40
21" x 54" x 72"	ESU215472V4	676.20
21" x 60" x 72"	ESU216072V4	721.40
21" x 72" x 72"	ESU217272V4	811.20

ESU212472V4	\$ 454.00
ESU213072V4	470.40
ESU213672V4	519.80
ESU214272V4	585.40
ESU214872V4	610.40
ESU215472V4	676.20
ESU216072V4	721.40
ESU217272V4	811.20

EA212472V4	\$ 363.20
EA213072V4	379.60
EA213672V4	429.00
EA214272V4	494.60
EA214872V4	519.60
EA215472V4	585.40
EA216072V4	630.60
EA217272V4	720.40

24" x 24" x 72"	ESU242472V4	\$ 465.30
24" x 30" x 72"	ESU243072V4	490.90
24" x 36" x 72"	ESU243672V4	533.90
24" x 42" x 72"	ESU244272V4	592.70
24" x 48" x 72"	ESU244872V4	631.10
24" x 54" x 72"	ESU245472V4	685.90
24" x 60" x 72"	ESU246072V4	726.70
24" x 72" x 72"	ESU247272V4	823.10

ESU242472V4	\$ 465.30
ESU243072V4	490.90
ESU243672V4	533.90
ESU244272V4	592.70
ESU244872V4	631.10
ESU245472V4	685.90
ESU246072V4	726.70
ESU247272V4	823.10

EA242472V4	\$ 373.75
EA243072V4	399.35
EA243672V4	442.35
EA244272V4	501.15
EA244872V4	539.55
EA245472V4	594.35
EA246072V4	635.15
EA247272V4	731.55

V5

5-SHELF VENTED UNITS

84"
HEIGHT

Starter units include 2 factory assembled stationary post kits, stationary traverses, stationary traverse dovetails and shelf plates. Add-On units include 1 factory assembled stationary post kit, stationary traverses, stationary traverse dovetails and shelf plates. Units ship complete in 1 box.

Starter

Add-On

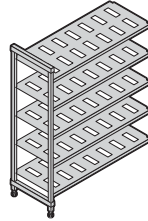
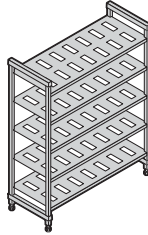

18"
DEPTH

DIMENSIONS D x L x H	CODE	LIST PRICE EA.
18" x 24" x 84"	ESU182484V5	\$ 509.40
18" x 30" x 84"	ESU183084V5	525.65
18" x 36" x 84"	ESU183684V5	579.15
18" x 42" x 84"	ESU184284V5	651.65
18" x 48" x 84"	ESU184884V5	677.65
18" x 54" x 84"	ESU185484V5	749.65
18" x 60" x 84"	ESU186084V5	799.15
18" x 72" x 84"	ESU187284V5	895.65

CODE	LIST PRICE EA.
EA182484V5	\$ 406.95
EA183084V5	423.20
EA183684V5	476.70
EA184284V5	549.20
EA184884V5	575.20
EA185484V5	647.20
EA186084V5	696.70
EA187284V5	793.20

21"
DEPTH

21" x 24" x 84"	ESU212484V5	\$ 549.60
21" x 30" x 84"	ESU213084V5	570.10
21" x 36" x 84"	ESU213684V5	631.85
21" x 42" x 84"	ESU214284V5	713.85
21" x 48" x 84"	ESU214884V5	745.10
21" x 54" x 84"	ESU215484V5	827.35
21" x 60" x 84"	ESU216084V5	883.85
21" x 72" x 84"	ESU217284V5	996.10

EA212484V5	\$ 445.05
EA213084V5	465.55
EA213684V5	527.30
EA214284V5	609.30
EA214884V5	640.55
EA215484V5	722.80
EA216084V5	779.30
EA217284V5	891.55

24"
DEPTH

24" x 24" x 84"	ESU242484V5	\$ 563.35
24" x 30" x 84"	ESU243084V5	595.35
24" x 36" x 84"	ESU243684V5	649.10
24" x 42" x 84"	ESU244284V5	722.60
24" x 48" x 84"	ESU244884V5	770.60
24" x 54" x 84"	ESU245484V5	839.10
24" x 60" x 84"	ESU246084V5	890.10
24" x 72" x 84"	ESU247284V5	1,010.60

EA242484V5	\$ 458.05
EA243084V5	490.05
EA243684V5	543.80
EA244284V5	617.30
EA244884V5	665.30
EA245484V5	733.80
EA246084V5	784.80
EA247284V5	905.30

Color: Brushed Graphite (580).

V4

4-SHELF VENTED MOBILE UNITS

Mobile units include 2 factory assembled mobile post kits, mobile traverses, mobile traverse dovetails, shelf plates, and 4 premium swivel casters with total locking brake. Units ship complete in 1 box.

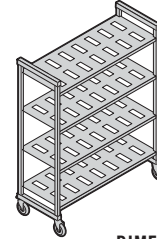

70"
HEIGHT

18"
DEPTH

CODE	DIMENSIONS D x L x H*	LIST PRICE EA.
EMU183670V4	18" x 36" x 70"	\$ 740.90
EMU184270V4	18" x 42" x 70"	798.70
EMU184870V4	18" x 48" x 70"	819.70
EMU185470V4	18" x 54" x 70"	877.10
EMU186070V4	18" x 60" x 70"	916.70

21"
DEPTH

EMU213670V4	21" x 36" x 70"	\$ 784.00
EMU214270V4	21" x 42" x 70"	849.80
EMU214870V4	21" x 48" x 70"	875.00
EMU215470V4	21" x 54" x 70"	940.40
EMU216070V4	21" x 60" x 70"	985.40

24"
DEPTH

EMU243670V4	24" x 36" x 70"	\$ 798.20
EMU244270V4	24" x 42" x 70"	856.80
EMU244870V4	24" x 48" x 70"	895.20
EMU245470V4	24" x 54" x 70"	950.00
EMU246070V4	24" x 60" x 70"	990.80

78"
HEIGHT

18"
DEPTH

CODE	DIMENSIONS D x L x H*	LIST PRICE EA.
EMU183678V4	18" x 36" x 78"	\$ 744.90
EMU184278V4	18" x 42" x 78"	802.70
EMU184878V4	18" x 48" x 78"	823.70
EMU185478V4	18" x 54" x 78"	881.10
EMU186078V4	18" x 60" x 78"	920.70

21"
DEPTH

EMU213678V4	21" x 36" x 78"	\$ 787.70
EMU214278V4	21" x 42" x 78"	853.50
EMU214878V4	21" x 48" x 78"	878.70
EMU215478V4	21" x 54" x 78"	944.10
EMU216078V4	21" x 60" x 78"	989.10

24"
DEPTH

EMU243678V4	24" x 36" x 78"	\$ 802.10
EMU244278V4	24" x 42" x 78"	860.70
EMU244878V4	24" x 48" x 78"	899.10
EMU245478V4	24" x 54" x 78"	953.90
EMU246078V4	24" x 60" x 78"	994.70

*Includes 5" casters.

CAMSHELVING® ELEMENTS SERIES

Corner Connectors

Unique patented design ensures maximum shelf space utilization. Use 1 set per shelf to connect starter and add-on units in corners. Connect 4 or 5 intermediate shelves between 2 starter units (2 sets required per shelf). Available as a single set or 8 or 10 set packs.

CODE	DESCRIPTION	LIST PRICE EA.
ECC1	1 Set for 1 shelf	\$ 5.95
ECC8	8 Sets for 4 shelves	47.60
ECC10	10 Sets for 5 shelves	59.50

Color: Brushed Graphite (580).

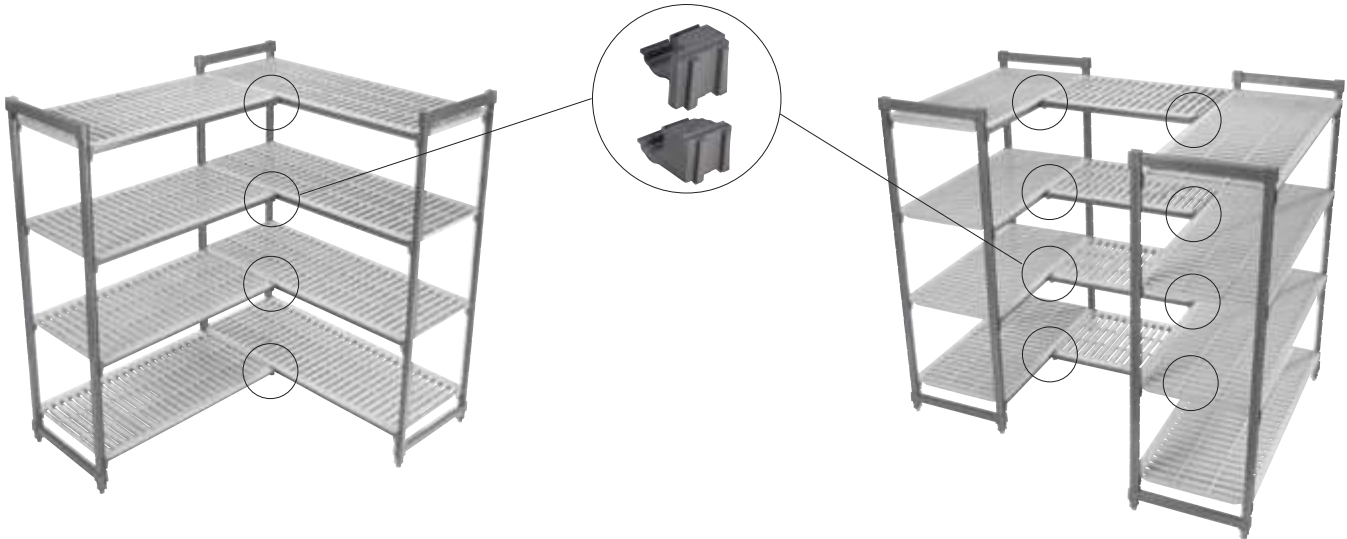

Bottom Shelf Dunnage Stands

Increase weight bearing capacity on bottom shelf only. Add to any shelf length. Highly recommended for starter units 54" and longer and all corner units, intermediate units and units specified for heavier load volume on and off bottom shelves.

CODE	DIMENSIONS D x H	LIST PRICE EA.
Dunnage Stand – Low		
EDS14H6	14" x 6½"	\$ 52.80
EDS18H6	18" x 6½"	54.50
EDS21H6	21" x 6½"	55.95
EDS24H6	24" x 6½"	57.25
Dunnage Stand – Tall		
EDS14H10	14" x 10½"	57.60
EDS18H10	18" x 10½"	59.30
EDS21H10	21" x 10½"	60.70
EDS24H10	24" x 10½"	62.05

Case Pack: 1 Color: Brushed Graphite (580).

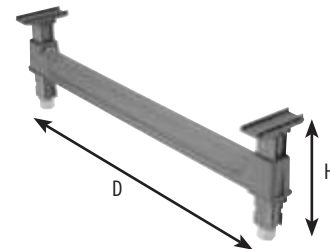

CAMSHELVING® ELEMENTS SERIES

Shelf Traverses

Available in single or double packs, stationary or mobile. Use two traverses to add an open shelf for divider bars or drying cradles. Add one stationary traverse onto back posts of a stationary unit for extra support when placing rolling equipment under the first shelf. Traverse dovetails included.

Stationary

LENGTH	SINGLE PACK CODE*	LIST PRICE EA.	DOUBLE PACK CODE**	LIST PRICE EA.
24"	ETR24	\$ 28.30	ETR242PK	\$ 53.90
30"	ETR30	30.60	ETR302PK	58.40
36"	ETR36	31.80	ETR362PK	60.70
42"	ETR42	34.00	ETR422PK	64.80
48"	ETR48	37.10	ETR482PK	70.70
54"	ETR54	40.20	ETR542PK	76.70
60"	ETR60	43.30	ETR602PK	82.70
72"	ETR72	49.50	—	—

*Case Pack: 1 **Case Pack: 2 Color: Brushed Graphite (580).

Mobile

LENGTH	SINGLE PACK CODE*	LIST PRICE EA.	DOUBLE PACK CODE**	LIST PRICE EA.
36"	EMTR36	\$ 43.50	EMTR362PK	\$ 69.00
42"	EMTR42	47.15	EMTR422PK	74.80
48"	EMTR48	50.75	EMTR482PK	80.50
54"	EMTR54	54.35	EMTR542PK	86.20
60"	EMTR60	58.00	EMTR602PK	92.00

*Case Pack: 1 **Case Pack: 2 Color: Brushed Graphite (580).



Stationary Traverse



Mobile Traverse



CAMSHELVING®

BASICS PLUS

series

STATIONARY

WHY CHOOSE BASICS PLUS?

Just because the budget is tight and storage needs are less rigorous, it doesn't mean that shelving performance and storage efficiencies should be compromised. Basics Plus Series is made from the same high performing, strong composite material as Elements Series and has the same design features. It's lighter in weight and less in cost but still strong enough to handle light to medium storage demands.



COMPONENT



Post Connectors, Corner Connectors, Floor Fastener, Wall Fastener, Shelf Rails, Single Shelf Security Cage, Shelf Divider Panels and Identification Tags are not NSF listed.

CAMSHELVING® BASICS PLUS SERIES

Stationary Unit Sizes

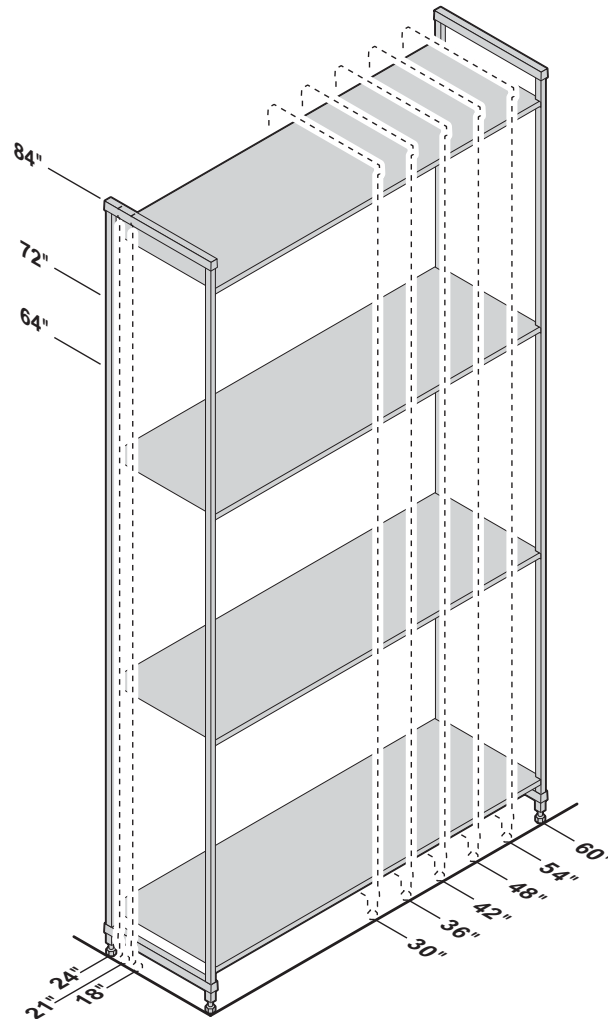

Weight Bearing Capacity

Weight must be evenly distributed across the entire shelf.

		UNIT LENGTH 30" – 48"	UNIT LENGTH 54" – 60"
SINGLE UNIT	Unit only	1800 lbs.	1800 lbs.
	Shelf only	700	500
	Unit with dunnage stand*	2100	2100
	Bottom shelf with dunnage stand*	1000	800
CORNER UNIT** With 2 Dunnage Stands required	Unit only	1350	—
	Shelf only	300	—
	Bottom shelf with dunnage stands*	450	—

*Dunnage Stands add stability and increase weight bearing capacity on bottom shelf only. Highly recommended for Starter Units 54" and longer, all Corner Units, U-Shape Units and units specified for heavier loads. (See Overall Length Quick Reference Guide).

** Corner connectors are for use only with shelves 30" – 48" long.

CAMSHELVING® BASICS PLUS SERIES – STARTER AND ADD-ON UNITS

V4 4-Shelf Vented Stationary Starter and Add-On Units

HEIGHTS	DEPTHS	LENGTHS	
3	3	6	
64"	18"	30"	48"
72"	21"	36"	54"
84"	24"	42"	60"

V5 5-Shelf Vented Stationary Starter and Add-On Units

HEIGHTS	DEPTHS	LENGTHS	
3	3	6	
64"	18"	30"	48"
72"	21"	36"	54"
84"	24"	42"	60"

S4 4-Shelf Solid Stationary Starter and Add-On Units

HEIGHTS	DEPTHS	LENGTHS	
3	3	6	
64"	18"	30"	48"
72"	21"	36"	54"
84"	24"	42"	60"

S5 5-Shelf Solid Stationary Starter and Add-On Units

HEIGHT	DEPTHS	LENGTHS	
1	3	6	
84"	18"	30"	48"
	21"	36"	54"
	24"	42"	60"

VS4 4-Shelf Vented and Solid Stationary Starter and Add-On Units (3 vented + 1 solid)

HEIGHTS	DEPTHS	LENGTHS	
3	3	6	
64"	18"	30"	48"
72"	21"	36"	54"
84"	24"	42"	60"

VS5 5-Shelf Vented and Solid Stationary Starter and Add-On Units (4 vented + 1 solid)

HEIGHT	DEPTHS	LENGTHS	
1	3	6	
84"	18"	30"	48"
	21"	36"	54"
	24"	42"	60"



Visit the Camshelving® website at www.cambro.com/camshelving for product information, assembly videos and design layouts, or to view or download the Camshelving Specification and Price List.



BASICS PLUS SERIES
64"
HEIGHT

V4
4-SHELF VENTED UNITS

Starter units include 2 factory assembled post kits and shelves. Add-on units include 1 factory assembled post kit and shelves. Units ship complete in 1 box.

Starter

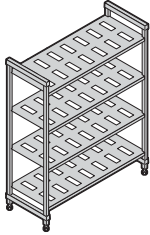

Add-On

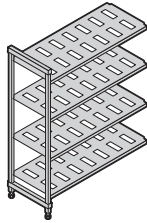

18"
DEPTH

DIMENSIONS D x L x H	CODE	LIST PRICE EA.	CODE	LIST PRICE EA.
18" x 30" x 64"	CBU183064V4	\$ 344.30	CBA183064V4	\$ 274.95
18" x 36" x 64"	CBU183664V4	378.10	CBA183664V4	308.75
18" x 42" x 64"	CBU184264V4	424.70	CBA184264V4	355.35
18" x 48" x 64"	CBU184864V4	441.30	CBA184864V4	371.95
18" x 54" x 64"	CBU185464V4	487.50	CBA185464V4	418.15
18" x 60" x 64"	CBU186064V4	518.90	CBA186064V4	449.55

21"
DEPTH

21" x 30" x 64"	CBU213064V4	\$ 373.20	CBA213064V4	\$ 302.10
21" x 36" x 64"	CBU213664V4	412.80	CBA213664V4	341.70
21" x 42" x 64"	CBU214264V4	465.40	CBA214264V4	394.30
21" x 48" x 64"	CBU214864V4	485.20	CBA214864V4	414.10
21" x 54" x 64"	CBU215464V4	538.20	CBA215464V4	467.10
21" x 60" x 64"	CBU216064V4	574.00	CBA216064V4	502.90

24"
DEPTH

24" x 30" x 64"	CBU243064V4	\$ 389.60	CBA243064V4	\$ 317.90
24" x 36" x 64"	CBU243664V4	424.20	CBA243664V4	352.50
24" x 42" x 64"	CBU244264V4	471.00	CBA244264V4	399.30
24" x 48" x 64"	CBU244864V4	501.80	CBA244864V4	430.10
24" x 54" x 64"	CBU245464V4	545.80	CBA245464V4	474.10
24" x 60" x 64"	CBU246064V4	578.20	CBA246064V4	506.50

Color: Brushed Graphite (580).

BASICS PLUS SERIES
72"
HEIGHT

V4
4-SHELF VENTED UNITS

Starter units include 2 factory assembled post kits and shelves. Add-on units include 1 factory assembled post kit and shelves. Units ship complete in 1 box.

Starter

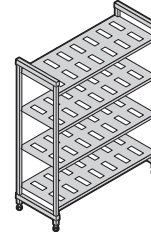

Add-On

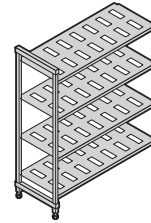

DIMENSIONS D x L x H	CODE	LIST PRICE EA.	CODE	LIST PRICE EA.
18" x 30" x 72"	CBU183072V4	\$ 347.40	CBA183072V4	\$ 276.50
18" x 36" x 72"	CBU183672V4	381.20	CBA183672V4	310.30
18" x 42" x 72"	CBU184272V4	427.80	CBA184272V4	356.90
18" x 48" x 72"	CBU184872V4	444.40	CBA184872V4	373.50
18" x 54" x 72"	CBU185472V4	490.60	CBA185472V4	419.70
18" x 60" x 72"	CBU186072V4	522.00	CBA186072V4	451.10

21" x 30" x 72"	CBU213072V4	\$ 376.20	CBA213072V4	\$ 303.60
21" x 36" x 72"	CBU213672V4	415.80	CBA213672V4	343.20
21" x 42" x 72"	CBU214272V4	468.40	CBA214272V4	395.80
21" x 48" x 72"	CBU214872V4	488.20	CBA214872V4	415.60
21" x 54" x 72"	CBU215472V4	541.20	CBA215472V4	468.60
21" x 60" x 72"	CBU216072V4	577.00	CBA216072V4	504.40

24" x 30" x 72"	CBU243072V4	\$ 392.70	CBA243072V4	\$ 319.45
24" x 36" x 72"	CBU243672V4	427.30	CBA243672V4	354.05
24" x 42" x 72"	CBU244272V4	474.10	CBA244272V4	400.85
24" x 48" x 72"	CBU244872V4	504.90	CBA244872V4	431.65
24" x 54" x 72"	CBU245472V4	548.90	CBA245472V4	475.65
24" x 60" x 72"	CBU246072V4	581.30	CBA246072V4	508.05



BASICS
PLUS
SERIES
84"
HEIGHT

V5
5-SHELF VENTED UNITS

Starter units include 2 factory assembled post kits and shelves. Add on units include 1 factory assembled post kit and shelves. Units ship complete in 1 box.

Starter

Add-On

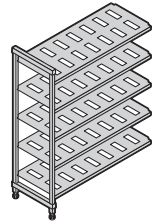
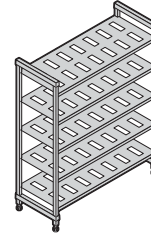

18"
DEPTH

DIMENSIONS D x L x H	CODE	LIST PRICE EA.	CODE	LIST PRICE EA.
18" x 30" x 84"	CBU183084V5	\$ 421.00	CBA183084V5	\$ 339.00
18" x 36" x 84"	CBU183684V5	463.25	CBA183684V5	381.25
18" x 42" x 84"	CBU184284V5	521.50	CBA184284V5	439.50
18" x 48" x 84"	CBU184884V5	542.25	CBA184884V5	460.25
18" x 54" x 84"	CBU185484V5	600.00	CBA185484V5	518.00
18" x 60" x 84"	CBU186084V5	639.25	CBA186084V5	557.25

21"
DEPTH

21" x 30" x 84"	CBU213084V5	\$ 456.05	CBA213084V5	\$ 372.40
21" x 36" x 84"	CBU213684V5	505.55	CBA213684V5	421.90
21" x 42" x 84"	CBU214284V5	571.30	CBA214284V5	487.65
21" x 48" x 84"	CBU214884V5	596.05	CBA214884V5	512.40
21" x 54" x 84"	CBU215484V5	662.30	CBA215484V5	578.65
21" x 60" x 84"	CBU216084V5	707.05	CBA216084V5	623.40

24"
DEPTH

24" x 30" x 84"	CBU243084V5	\$ 476.25	CBA243084V5	\$ 392.00
24" x 36" x 84"	CBU243684V5	519.50	CBA243684V5	435.25
24" x 42" x 84"	CBU244284V5	578.00	CBA244284V5	493.75
24" x 48" x 84"	CBU244884V5	616.50	CBA244884V5	532.25
24" x 54" x 84"	CBU245484V5	671.50	CBA245484V5	587.25
24" x 60" x 84"	CBU246084V5	712.00	CBA246084V5	627.75

Color: Brushed Graphite (580).

CAMSHELVING® BASICS PLUS SERIES

Corner Connectors

Unique patented design ensures maximum shelf space utilization. Use 1 set per shelf to connect starter and add-on units in corners. Connect 4 or 5 intermediate shelves between 2 starter units (2 sets required per shelf). Available as a single set or 8 or 10 set packs.

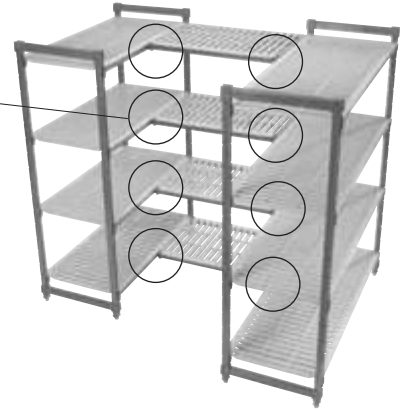
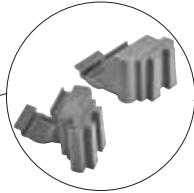

CODE	DESCRIPTION	LIST PRICE EA.
CBCC1	1 Set for 1 shelf	\$ 5.65
CBCC8	8 Sets for 4 shelves	45.20
CBCC10	10 Sets for 5 shelves	56.50

Color: Brushed Graphite (580).

Bottom Shelf Dunnage Stands

Increase weight bearing capacity on bottom shelf only. Add to any shelf length. Highly recommended for starter units 54" and longer and all corner units, intermediate units and units specified for heavier load volume on and off bottom shelves.

CODE	DIMENSIONS D x H	LIST PRICE EA.
Dunnage Stand – Low		
CBDS18H6	18" x 6¾"	\$ 51.75
CBDS21H6	21" x 6¾"	53.15
CBDS24H6	24" x 6¾"	54.40
Dunnage Stand – Tall		
CBDS18H10	18" x 10¾"	51.95
CBDS21H10	21" x 10¾"	53.35
CBDS24H10	24" x 10¾"	54.60

Case Pack: 1 Color: Brushed Graphite (580).

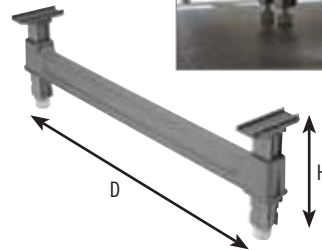

Shelf Traverses

Add one traverse onto back posts for extra support when placing rolling equipment under the first shelf. Traverse dovetails included.

LENGTH	SINGLE PACK CODE*	LIST PRICE EA.	DOUBLE PACK CODE**	LIST PRICE EA.
30"	CBTR30	\$ 27.80	CBTR302PK	\$ 50.50
36"	CBTR36	28.00	CBTR362PK	50.90
42"	CBTR42	31.10	CBTR422PK	56.40
48"	CBTR48	34.00	CBTR482PK	61.80
54"	CBTR54	37.10	CBTR542PK	67.30
60"	CBTR60	39.90	CBTR602PK	72.50

*Case Pack: 1 **Case Pack: 2 Color: Brushed Graphite (580).

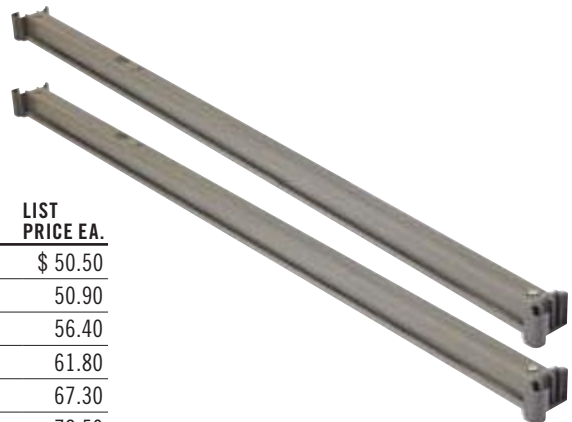

CAMSHELVING® ACCESSORIES

Identification Tags

Clip onto shelf traverses to clearly identify stored product. Made of highly durable plastic with a clear slide in front panel. 14 labels included: 12 color-coded, pre-printed and 2 blank.

CODE	DESCRIPTION	DIMENSION L x H	LIST PRICE EA.
Premium and Elements Series			
CSID6	6" ID Tag	6" x 1"	\$ 2.30
CSID3	3" ID Tag	3" x 1"	2.30
Basics Plus Series			
CBID6	6" ID Tag	6" x 1"	2.90

Case Pack: 12 **Color:** White / Clear.
Pre-printed, color labels, 2 each: Blue - Cooked Foods, Beige - Fish, Yellow - Poultry, White - Dairy, Green - Fruits and Vegetables, Red - Raw Meat.



Wall Fastener

Use to secure stationary shelving unit to a wall for added safety and stability where required. Made of stainless steel. Screws not included.

CODE	DIMENSION D x L x H	LIST PRICE EA.
CSWF	2 7/8" x 9 3/8" x 1 1/8"	\$ 25.75

Case Pack: 4 **Color:** Silver (000).



Hole diameter 7/16".



Floor Fasteners

Secure stationary unit posts directly to the floor for added safety and stability where required. Made of stainless steel. Bolts not included.

CODE	DIMENSION D x L x H	LIST PRICE EA.
Premium, Elements & Basics Plus Series		
CSFF	1 1/2" x 6 1/2" x 3 1/2"	\$ 33.00
Premium Series High Density		
CSHDF	1 3/8" x 4 1/4" x 1/2"	\$ 33.00

CSFF Case Pack: 2
CSHDF Case Pack: 4
Color: Silver (000).



Hole diameter 9/16".



Donut Bumper

Offers added protection during transport and when maneuvering mobile units into place against walls or alongside other units for storage.

CODE	DIAMETER	LIST PRICE EA.
Premium Series		
CPMDB	3 1/2"	\$ 9.60
Premium Series High Density		
CSMHDB	5"	11.00
Elements Series		
CSMHDB	5"	11.00

Case Pack: 4 **Color:** Gray (000).

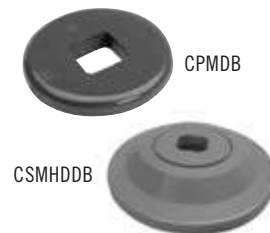

Shelf Divider Panel

Stack and separate items stored on shelves. Made of highly durable plastic. Installs directly onto solid or vented shelves. Easily removable for relocating or washing. Use with Shelf Rails to prevent contents from falling off shelves.

CODE	DIMENSION D x H	LIST PRICE EA.
CSSD188	18" x 8"	\$ 17.50
CSSD218	21" x 8"	19.05
CSSD248	24" x 8"	20.60

Case Pack: 1 **Color:** Soft Gray (151).



CAMSHELVING® ACCESSORIES

Shelf Divider Bars (for 24" deep shelf only)

Create a custom service or storage station for food pans, boxes or dish racks. Install straight or angled dividers directly onto shelf traverses.

CODE	DESCRIPTION	LIST PRICE EA.
Premium Series		
CSDBA	Angled Divider Bar	\$ 5.95
CSDBS	Straight Divider Bar	5.95
Elements Series		
EDBA	Angled Divider Bar	4.55
EDBS	Straight Divider Bar	4.55

Case Pack: 4 Color: Speckled Gray (480).



Shelf Rails

Use to prevent contents from falling off shelves. Protect individual sides or ends or wrap a full shelf. Rods are made from a strong composite material that is highly durable and will never rust or corrode.

Fits shelving units 24" to 72" wide and 14" to 24" deep.

Full or three-quarter shelf kits help to streamline installations and significantly reduces carton waste.

Shelf Rail kits are available in all depths and all lengths. To see the entire selection of Full & 3/4 kits, see the Camshelving Product Specification and Price List.

Full Shelf Rail Kits

PREMIUM CODE	ELEMENTS CODE	New! BASICS PLUS CODE	DIMENSION D x L	LIST PRICE EA.
Full Shelf Rail Kits (2 sides, 2 ends)				
CPR2436	ESR2436	CBR2436	24" x 36"	\$ 125.05
CPR2442	ESR2442	CBR2442	24" x 42"	133.20
CPR2448	ESR2448	CBR2448	24" x 48"	139.25
3/4 Shelf Rail Kits (1 side, 2 ends)				
CPR24363	ESR24363	CBR24363	24" x 36"	89.50
CPR24423	ESR24423	CBR24423	24" x 42"	93.60
CPR24483	ESR24483	CBR24483	24" x 48"	96.60

Case Pack: 1 Color: Soft Gray (151).

Single Side Rail Kits

PREMIUM CODE	ELEMENTS CODE	New! BASICS PLUS CODE	DIMENSION LENGTH	LIST PRICE EA.
CPR24S	ESR24S	—	24"	\$ 29.55
CPR30S	ESR30S	CBR30S	30"	32.50
CPR36S	ESR36S	CBR36S	36"	35.55
CPR42S	ESR42S	CBR42S	42"	39.60
CPR48S	ESR48S	CBR48S	48"	42.65
CPR54S	ESR54S	CBR54S	54"	46.65
CPR60S	ESR60S	CBR60S	60"	49.65
CPR72S	ESR72S	—	72"	56.75

Case Pack: 1 Color: Soft Gray (151).

Single End Rail Kits

PREMIUM CODE	ELEMENTS CODE	New! BASICS PLUS CODE	DIMENSION DEPTH	LIST PRICE EA.
CPR14E	ESR14E	—	14"	\$ 22.40
CPR18E	ESR18E	CBR18E	18"	24.20
CPR21E	ESR21E	CBR21E	21"	25.55
CPR24E	ESR24E	CBR24E	24"	27.00

Case Pack: 1 Color: Soft Gray (151).



CAMSHELVING® ACCESSORIES

Ultimate Sheet Pan Rack for Single Shelf

The lightweight, durable Ultimate Sheet Pan Rack for Single Shelf will transform your storage capabilities. Designed to fit securely on a 24" deep Camshelving unit, this single shelf rack holds 6 full size (1826) or 12 half size (1318) sheet pans in a compact space. Use to stage and hold prepped ingredients, defrost product in the cooler or quickly cool baked goods. Designed to accept pans directly out of a 350°F oven. Ships knockdown.

CODE	DIMENSION D x L x H	LIST PRICE EA.
Premium or Elements Series		
CSUPR1826S6	24 $\frac{1}{8}$ " x 20 $\frac{1}{2}$ " x 20 $\frac{1}{4}$ "	\$ 180.00
Basics Plus Series		
CBUPR1826S6	24 $\frac{1}{8}$ " x 20 $\frac{1}{2}$ " x 20 $\frac{1}{4}$ "	180.00
Case Pack: 1 Color: Brushed Graphite (580). Patent Pending.		



New!



Single Shelf Security Cage (for 24" deep shelf only)

Securely store valuable products on a single shelf. Made of heavy duty, 304 stainless steel for use in any environment. Requires 18" height between shelves. Install on vented shelves only. Lock not included.

CODE	DIMENSION D x L x H	LIST PRICE EA.
CSSC244818	25 $\frac{1}{4}$ " x 42 $\frac{1}{2}$ " x 18"	\$ 659.20
Case Pack: 1 Color: Silver (000).		





UTILITY SHELVING – CAMSHELVING® ULTIMATE #10 CAN RACK SYSTEM

Create the can storage system your operation needs with the Ultimate #10 Can Rack. This first ever plastic can rack makes storing and inventorying #10 and #5 cans so much easier.

- Front-loading, gravity-fed system supports FIFO organization and food rotation with no need to move the rack for loading or unloading.
- Made with easy to clean, smooth surfaces. Can be completely disassembled and run through the dishwasher.
- Lifetime warranty against rust and corrosion. Made from durable, reinforced plastic material.
- Single, Add-on Can Racks and Full-Size Can Rack Units each ship complete in 1 box. Units include pre-assembled post kits.

Color: Brushed Graphite (580).

Ultimate #10 Can Rack is covered by U.S. Patents D828,145 S and D827,421 S.

NSF Component on shelving only.



New!

Easy to assemble, a few simple parts click together to build single and add-on racks.



Storage Capacity

	#10 Can	#5 Can
SINGLE OR ADD-ON CAN RACK	8 each	12 each
FULL-SIZE CAN RACK UNIT (26" x 36" x 72", 3 tiers)	96	144

Holds #10 and #5 cans 6.7" to 7.07" tall.



Premium Series

Elements Series

Full Size Stationary Can Rack Unit

This free-standing can rack holds up to 96 cans in a compact space. Install on the end of a Camshelving High Density unit for maximum space utilization. Ships knockdown in 1 box with 2 factory-assembled post kits.



Full Size Stationary Add-on Can Rack Unit

Maximize every inch of linear space in your kitchen or dry storage area with an in-line can rack. With just 1 factory assembled post kit, connect a can rack to standard shelving units in a straight line by sharing posts.



Partial Can Rack Storage

Install a single row of can storage on any 24" deep Camshelving unit, utilizing shelf space above or below for standard storage items.



UTILITY SHELVING – CAMSHELVING® ULTIMATE #10 CAN RACK SYSTEM



CODE	CPU243672C96*	ESU243672C96*	CPA243672C96**	EA243672C96**
DESCRIPTION	Premium Series Full-Size Stationary Can Rack Unit (Free Standing)	Elements Series Full-Size Stationary Can Rack Unit (Free Standing)	Premium Series Full-Size Add-On Can Rack Unit (Shared Post)	Elements Series Full-Size Add-On Can Rack Unit (Shared Post)
DIMENSION D x L x H	26" x 36" x 72"	26" x 36" x 72"	26" x 34 1/4" x 72"	26" x 34" x 72"
LIST PRICE EACH	\$ 980.00	\$ 865.00	\$ 830.00	\$ 755.00

Case Pack: 1 Ships in 1 box. **Premium Series Color:** Speckled Gray (480). **Elements Series Color:** Brushed Graphite (580).

*Unit includes: 2 pre-assembled post kits, 9 traverses, 15 panels and 72 brackets. **Unit includes: 1 pre-assembled post kit, 9 traverses, 15 panels and 72 brackets.

Single and Add-on Can Racks

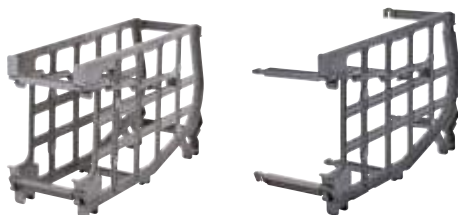

CODE	UCR10R8	UCR10AR8
DESCRIPTION	Single Can Rack, 2 panels and 6 brackets	Add-on Can Rack, 1 panel and 6 brackets
DIMENSION D x L x H	26" x 9 1/4" x 15 1/2"	26" x 7 1/4" x 15 1/2"
LIST PRICE EACH	\$ 110.00	\$ 65.00

Case Pack: 1 **Color:** Brushed Graphite (580).



Can Racks Per Length

SHELF LENGTH	NUMBER OF CAN RACKS PER TIER*	LEFTOVER SHELF SPACE	#10 CAN HOLDING CAPACITY
24"	2	3.5"	16
30"	3	2"	24
36"	4	0"	32
42"	4	6.5"	32
48"	5	5"	40
54"	6	3.5"	48
60"	7	2"	56

*1 Single Rack plus Add-on Racks.

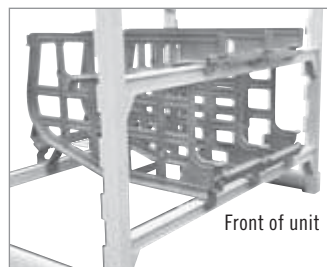

Front of unit

NOTE: Each tier of can racks requires 3 traverses, 2 front and 1 rear. Leave two open dovetails above top traverse before installing the next traverse/tier. This allows space to load cans.

UTILITY SHELVING – CAMSHELVING® ULTIMATE SHEET PAN RACK



Smart Design. Quality Construction.

The classic sheet pan rack has been re-imagined and re-engineered to provide unparalleled performance and value. Made from revolutionary composite plastic materials, the Ultimate Sheet Pan Rack will forever change your expectations of speed racks.

- Backed by a lifetime warranty against rust and corrosion.
- Made with easy to clean, smooth surfaces.
- All components are replaceable.
- Cold use: Coolers, Freezers and Blast Chillers.
- Hot use: Proofing and Retarding. Accepts sheet pans from ovens up to 350°F.
- Top Frame supports a full size 1826 sheet pan to protect contents below or create a light-duty work space. Also holds a Camwear® pizza dough box.

Color: Brushed Graphite (580)

Full Rack Temperature Tolerance: -36° to 190°F

Racks are not intended for use inside roll-in ovens. Do not use with or place near open flame or hot surfaces above 350°F.

Ultimate Sheet Pan Rack is covered by U.S. Patent D 853,070 S and D 841,273 S.



Holds full-size (1826) and half-size (1318) sheet pans.

End load design with no middle crossbar provides quick and easy access to rack contents.



Positioning ribs on ends help to keep sheet pans centered on rails.

Molded in ribs promote airflow for efficient cooling or thawing.



Choose from 3" or 1½" rail spacing.

ABOUT RAIL SPACING



3" rails are most versatile. This "speed rack" style allows for quick loading and unloading. It also allows for maximum capacity per tray side to side.



1½" rails are best for high productivity or bakery applications for maximum holding capacity.

UTILITY SHELVING – CAMSHELVING® ULTIMATE SHEET PAN RACK



Full Size Racks



UPR1826F20



UPR1826FP20



UPR1826F40



UPR1826FP40

CODE	DIMENSIONS L x W x H*	RAIL SPACING	HOLDING CAPACITY	CASTER TYPE	LIST PRICE EA.
Knockdown (KD) Units					
UPR1826F20	32 ¹ / ₁₆ " x 25 ¹ / ₂ " x 71 ³ / ₈ "	3"	20 Sheet pans/trays	Metal	\$ 715.00
UPR1826FP20	33 ³ / ₈ " x 25 ¹ / ₁₆ " x 71 ³ / ₈ "	3"	20 Sheet pans/trays	Plastic	765.00
UPR1826F40	32 ¹ / ₁₆ " x 25 ¹ / ₂ " x 71 ³ / ₈ "	1 ¹ / ₂ "	40 Sheet pans/trays	Metal	725.00
UPR1826FP40	33 ³ / ₈ " x 25 ¹ / ₁₆ " x 71 ³ / ₈ "	1 ¹ / ₂ "	40 Sheet pans/trays	Plastic	775.00
Factory Assembled (FA) Units					
UPR1826FA20	32 ¹ / ₁₆ " x 25 ¹ / ₂ " x 71 ³ / ₈ "	3"	20 Sheet pans/trays	Metal	925.00
UPR1826FPA20	33 ³ / ₈ " x 25 ¹ / ₁₆ " x 71 ³ / ₈ "	3"	20 Sheet pans/trays	Plastic	995.00
UPR1826FA40	32 ¹ / ₁₆ " x 25 ¹ / ₂ " x 71 ³ / ₈ "	1 ¹ / ₂ "	40 Sheet pans/trays	Metal	985.00
UPR1826FPA40	33 ³ / ₈ " x 25 ¹ / ₁₆ " x 71 ³ / ₈ "	1 ¹ / ₂ "	40 Sheet pans/trays	Plastic	1,055.00

Case Pack: 1 **Color:** Brushed Graphite (580). **Weight capacity:** 350 lbs. per rack, 55 lbs. per rail set. *Dimensions include casters.

CASTER COMPARISON



Why Choose Metal?

- An affordable, all purpose caster that can go anywhere in the kitchen (except freezers).
- Custom center-stem design enhances rack stability, even across uneven surfaces.
- Zinc-plated frame with non-marking polyurethane wheel.
- Racks include 4 swivel casters, 2 with brake, 2 without.
- 5" for Full and Half Size racks; 3" for Undercounter racks.



Why Choose Plastic?

- Offers a 100% rust and corrosion-free rack from top to bottom.
- Ideal for use in any kitchen environment, including freezers and blast chillers.
- Nylon frame with non-marking thermoplastic rubber wheel.
- Racks include 4 each 5" swivel casters with total locking brake that locks both swivel and wheel.
- Available on Full and Half Size racks only.

UTILITY SHELVING – CAMSHELVING® ULTIMATE SHEET PAN RACK



Half Size Racks



UPR1826H12



UPR1826HP12



UPR1826H20



UPR1826HP20

CODE	DIMENSIONS L x W x H*	RAIL SPACING	HOLDING CAPACITY	CASTER TYPE	LIST PRICE EA.
UPR1826H12	32 ¹ / ₁₆ " x 25 ¹ / ₂ " x 47 ¹ / ₂ "	3"	12 Sheet pans/trays	Metal	\$ 510.00
UPR1826HP12	33 ³ / ₈ " x 25 ¹ / ₁₆ " x 47 ³ / ₄ "	3"	12 Sheet pans/trays	Plastic	560.00
UPR1826H20	32 ¹ / ₁₆ " x 25 ¹ / ₂ " x 47 ¹ / ₂ "	1 ¹ / ₂ "	20 Sheet pans/trays	Metal	565.00
UPR1826HP20	33 ³ / ₈ " x 25 ¹ / ₁₆ " x 47 ³ / ₄ "	1 ¹ / ₂ "	20 Sheet pans/trays	Plastic	615.00

Case Pack: 1 Color: Brushed Graphite (580). Weight capacity: 175 lbs. per rack, 55 lbs. per rail set. *Dimensions include casters.

Undercounter Racks



UPR1826U8



UPR1826U15

CODE	DIMENSIONS L x W x H*	RAIL SPACING	HOLDING CAPACITY	LIST PRICE EA.
UPR1826U8	30 ⁷ / ₈ " x 23 ³ / ₄ " x 33 ³ / ₈ "	3"	8 Sheet pans/trays	\$ 495.00
UPR1826U15	30 ⁷ / ₈ " x 23 ³ / ₄ " x 31 ¹ / ₂ "	1 ¹ / ₂ "	15 Sheet pans/trays	540.00

Case Pack: 1 Color: Brushed Graphite (580). *Dimensions include casters. Weight capacity: 90 lbs. per rack, 55 lbs. per rail set. Undercounter racks available with 3" metal casters only.

Full Size Ultimate Sheet Pan Rack Cover

- Choose from vinyl or insulated with 2 front, full-length zippers and clear identification pocket.
- Insulated cover made of durable insulated nylon, helps keep food hot or cold for up to an hour.
- Vinyl cover made of clear reinforced plastic.



CODE	GBCRC272165	GBIRC272165
DESCRIPTION	Vinyl Cover	Insulated Cover
DIMENSIONS L x W x H	27 ¹ / ₂ " x 21 ¹ / ₂ " x 65"	27 ¹ / ₂ " x 21 ¹ / ₂ " x 65"
COLOR	Clear	Black (110)
LIST PRICE EA.	\$ 210.00	\$ 585.00

Case Pack: 1

UTILITY SHELVING

Premium Series Full-Wrap Security Cage for D 24" x L 48" shelf and H 64" stationary or H 67" mobile

Store valuable products behind locked doors. Made of heavy-duty 304 stainless steel for use in any environment. Stationary or mobile units ship complete with factory assembled post kits, 2 vented shelves, 4 premium swivel casters with total locking brake for mobile unit and 1 full wrap security cage. Can be used with Divider Panels. Assembly requires bottom vented shelf. Additional shelves can be ordered separately. Cage and Units ship knockdown. Lock not included.



CODE	CPFWSC244860	CPU244864SUPKG	CPMU244867SUPKG
DESCRIPTION	Full-wrap Security Cage only	Full-wrap Stationary Security Unit	Full-wrap Mobile Security Unit
DIMENSION D x L x H	26¾" x 50¼" x 61½"	26¾" x 50¼" x 64½"	26¾" x 50¼" x 67¾"
COLOR	Silver (000)	Speckled Gray (480)	Speckled Gray (480)
LIST PRICE EA.	\$ 3,038.50	\$ 3,566.05	\$ 3,863.75

Case Pack: 1 Cage only ships in 1 box. Units ship in 2 boxes.

Vertical Drying and Storage Rack

Promotes sanitary drying, safe handling and efficient storage for trays, sheet pans, cutting boards and lids. Can be used with Shelf Rails to prevent contents from sliding off.

Units ship complete with factory assembled mobile post kits, 6 traverses, 12 or 15 vertical drying cradles and premium swivel casters with total locking brake. Assembly required.



Modular 7-slot rack can be ordered separately to customize a drying and storage rack. Made of highly durable ABS plastic. Slots are spaced 1½" wide and dividers are 2½" high.



CODE	DIMENSIONS D x L x H	HOLDING CAPACITY	CASE PACK	LIST PRICE EA.
Premium Series Vertical Drying and Storage Rack				
CPMU244875DRPKG	24" x 48" x 75"	84 Trays	1	\$ 1,454.15
CPMU246075DRPKG	24" x 60" x 75"	105 Trays	1	1,626.30
Vertical Drying and Storage Cradle for 24" deep shelf only (Fits all Camshelving® lines)				
CSDR7	23½" x 10¼" x 3¾"	—	1	57.70
CSDR73	23½" x 10¼" x 3¾"	—	3	173.10

Drying Rack Color: Speckled Gray (480). Drying Cradle Color: Soft Gray (151).
48" long unit ships in 5 boxes. 60" long unit ships in 6 boxes.

UTILITY SHELVING

Angled Drying and Storage Rack

Promotes sanitary drying, safe handling and efficient product organization with easy access to product.

Unit ships complete with factory assembled mobile post kits, 8 traverses, 16 angled drying cradles and premium swivel casters with total locking brake. Assembly required.



Uniquely designed cradle holds up to 8 each meal delivery pellets or use to dry, store and transport food pans and other commercial kitchen ware. Installs directly onto shelf traverses. Made of highly durable ABS plastic. Slots are spaced 2 $\frac{3}{8}$ " apart.



CODE	DIMENSIONS D x L x H	HOLDING CAPACITY	CASE PACK	LIST PRICE EA.
Premium Series Angled Drying and Storage Rack				
CPMU244875PDPKG	24" x 48" x 75"	128 Pellets and Bases or 16 GN 1/1 Food Pans	1	\$ 1,531.30
Angled Drying and Storage Cradle for 24" deep shelf only (Fits all Camshelving® lines)				
CSDR8	23 $\frac{3}{16}$ " x 10 $\frac{1}{8}$ " x 6 $\frac{1}{16}$ "	—	1	46.35
CSDR84	23 $\frac{3}{16}$ " x 10 $\frac{1}{8}$ " x 6 $\frac{1}{16}$ "	—	4	185.40

Drying Rack Color: Speckled Gray (480). CPMU244875PDPKG Ships in 5 boxes.
Drying Cradle Color: Soft Gray (151).

Dome Drying and Storage Rack

Promotes sanitary drying, safe handling and efficient product organization with easy access to product.

Unit ships complete with factory assembled mobile post kits, 10 traverses, 10 dome drying cradles and premium swivel casters with total locking brake. Assembly required.

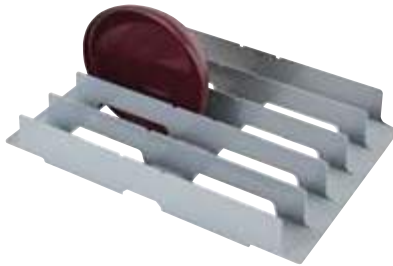

Use to dry and safely store up to 10 patient meal delivery domes or plate covers upright. Installs directly onto shelf traverses. Made of highly durable ABS plastic. Slots are spaced 3 $\frac{1}{16}$ " apart.



CODE	DIMENSIONS D x L x H	HOLDING CAPACITY	CASE PACK	LIST PRICE EA.
Premium Series Dome Drying and Storage Rack				
CPMU243675DDPKG	24" x 36" x 75"	100 Domes	1	\$ 1,490.00
Dome Drying and Storage Cradle for 24" deep shelf only (Fits all Camshelving® lines)				
CSDDC24	24" x 16 $\frac{2}{3}$ " x 3 $\frac{3}{8}$ "	—	1	67.00
CSDDC245	24" x 16 $\frac{2}{3}$ " x 3 $\frac{3}{8}$ "	—	5	335.00

Drying Rack Color: Speckled Gray (480). CPMU243675DDPKG Ships in 3 boxes.
Drying Cradle Color: Soft Gray (151).

UTILITY SHELVING

Elements Series 2-Shelf Vented Undercounter Units

Create storage in underutilized or hard-to-reach undercounter areas. Ideal for storing condiments, to-go containers, and paper disposables. Stationary units include 2 factory assembled stationary post kits, 4 stationary traverses, stationary traverse dovetails and shelf plates.

Mobile units include 2 factory assembled mobile post kits, 4 mobile traverses, mobile traverse dovetails, shelf plates, and 4 premium swivel casters with total locking brake.



CODE	DIMENSIONS D x L x H*	LIST PRICE EA.
Stationary Units		
ESU183630V2	18" x 36" x 30"	\$ 298.40
ESU184830V2	18" x 48" x 30"	336.70
Mobile Units		
EMU142427V2	14" x 24" x 27"	513.60
EMU143627V2	14" x 36" x 27"	577.10
EMU144827V2	14" x 48" x 27"	616.50

Color: Brushed Graphite (580). Ships in 1 box. *Height includes casters.



New!

Shown with 3/4 Shelf Rail Kit.

Premium Series Flex Station

This versatile unit can serve as a convenient Grab and Go station, product merchandiser, or use for delivery staging area, utensil storage and much more.

Unit Includes: 2 factory assembled mobile post kits, 8 traverses, 36 angled divider bars (4 extra) 4 total locking casters and 24 identification tags. Assembly required.

Food pans, food boxes and other accessories sold separately.

CODE	DESCRIPTION	DIMENSIONS D x L x H*	LIST PRICE EA.
CPMU244867FXPKG	Premium Series Flex Station	24" x 48" x 67"	\$ 1,068.90

Color: Speckled Gray (480). Ships in 1 box. *Height includes casters.



CAMSHELVING® WALL SHELVES AND SHELF EXTENDERS

Wall Shelves

- Expand storage space in kitchens, above work stations and sinks.
- Features virtually indestructible I-beam supports that hold up to 150 lbs. per shelf.
- Durable polypropylene withstands temperatures up to 190°F, and will not rust or corrode.

- Snap fit rail design allows shelves to snap on and off for easy cleaning.
- 2" backsplash and marine front edge controls spills and cross contamination.

Shelf Extenders

- Convert empty wall space into a functional storage area.
- Use with or without Camshelving Wall Shelves.
- Peg strips withstand temperatures up to 190°F, and will not rust or corrode.

Wall Shelf Color: Speckled Gray (480).

Extender Peg Strip Color: Black (110).



Shelf Extenders ship in one carton with all hardware and includes:

LENGTH	PEG STRIPS	BRACKETS	HOOKS
36"	3	2	6
48"	3	3	9

Wall Shelves 14" Depth



CODE	CSWS1436SK	CSWS1448SK	CSWS1436VK	CSWS1448VK
DESCRIPTION	36" x 14" wall shelf, solid	48" x 14" wall shelf, solid	36" x 14" wall shelf, vented	48" x 14" wall shelf, vented
EXTERIOR DIMENSIONS	L 36" x D 14" x H 13½"	L 48" x D 14" x H 13½"	L 36" x D 14" x H 13½"	L 48" x D 14" x H 13½"
LIST PRICE EACH	\$ 156.95	\$ 180.25	\$ 156.95	\$ 180.25

Case Pack: 1

Wall Shelves 18" Depth



CODE	CSWS1836SK	CSWS1848SK	CSWS36EK	CSWS48EK
DESCRIPTION	36" x 18" wall shelf, solid	48" x 18" wall shelf, solid	36" shelf extender	48" shelf extender
EXTERIOR DIMENSIONS	L 36" x D 18" x H 13½"	L 48" x D 18" x H 13½"	L 35½" x D 2" x H 15½"	L 47½" x D 2" x H 15½"
LIST PRICE EACH	\$ 180.25	\$ 197.65	\$ 217.50	\$ 323.55

Case Pack: 1

Shelf Extenders

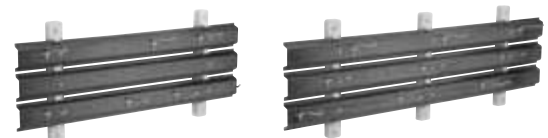

DUNNAGE RACKS



S-Series Dunnage Racks

Colors: Dark Brown (131),
Speckled Gray (480).

- Keep frozen, cold or dry inventory 12" safely off the floor.
- One piece construction and sturdy legs provide strength and stability.
- Heavy duty polypropylene is safe to -36°F, and will not rust, corrode or bend.
- Choose slotted tops for maximum air circulation around perishable products.
- Solid tops catch spills for easy clean up.



CODE	EXTERIOR DIMENSIONS L x D x H	LOAD CAPACITY	LIST PRICE EA.
Solid Top			
DRS30	30" x 21" x 12"	1500 lbs.	\$ 242.05
DRS36	36" x 21" x 12"	1500	262.65
DRS48	48" x 21" x 12"	3000	314.15
DRS60	60" x 21" x 12"	3000	360.50
Slotted Top			
DRS300	30" x 21" x 12"	1500	242.05
DRS360	36" x 21" x 12"	1500	262.65
DRS480	48" x 21" x 12"	3000	314.15
DRS600	60" x 21" x 12"	3000	360.50

Case Pack: 1 InStock Color: Speckled Gray (480).

Camlink®

Camlink connectors securely lock dunnage racks together for greater stability.



CODE	CASE PACK	LIST PRICE EA.
DRLNK	6	\$ 2.45

Color: Black (110).

Camlink fits all sizes and styles. One free Camlink supplied with every Dunnage Rack.



STORAGE



CAMWEAR® CAMSQUARE® FOOD STORAGE CONTAINERS



Maximize your storage area with CamSquare food storage containers. The square shape provides 33% better space usage than traditional round containers. Clear Camwear provides product visibility for at a glance inventory management.

Note: All graduations are approximate.



Crystal clear, virtually unbreakable Camwear withstands temperatures from -40° to 210°F (-40° to 99°C).

Wide molded-in handles on larger sizes ease carrying. Molded-in holes offer quick and sanitary drying.

Resists food acids, oils & alcohol. Stain and odor resistant.

Interstacking saves space when not in use.

Color graduations printed on the outside for quick inventory management.

Graduation marks are both engraved and color-printed to ensure long-term readability.

Seal Covers for Camwear CamSquares*

- Inner and outer seal provide excellent spill resistance.
- Helps to extend the shelf life of contents.
- Includes a hole on the corner for hanging during storage.
- Withstands temperatures from -40° to 160°F (-40° to 70°C).

*Seal Covers fit Camwear CamSquare containers only and are not airtight.

Strawberry Shelf Life (in days)

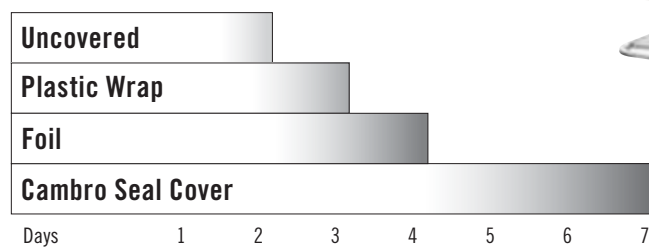

CAMWEAR® CAMSQUARE® FOOD STORAGE CONTAINERS



Camwear



CODE	2SFSCW	4SFSCW	6SFSCW	8SFSCW	12SFSCW**	18SFSCW**	22SFSCW**
CAPACITY	2 qt.	4 qt.	6 qt.	8 qt.	12 qt.	18 qt.	22 qt.
DIM. L x W x H	7¼" x 7¼" x 3⅞"	7¼" x 7¼" x 7⅞"	8⅞" x 8⅞" x 7¼"	8⅞" x 8⅞" x 9⅞"	11¼" x 12¼" x 8¾"	11¼" x 12¼" x 12⅞"	11¼" x 12¼" x 15¾"
LIST PRICE EACH	\$ 8.55	\$ 13.05	\$ 16.90	\$ 19.85	\$ 26.45	\$ 39.25	\$ 49.75

Case Pack: 6 Color/InStock Color: Clear (135). Height includes covers.



Seal Covers for Camwear CamSquares*



CODE	SFC2SCPP	SFC6SCPP	SFC12SCPP
DESCRIPTION	Fits 2 & 4 qt.	Fits 6 & 8 qt.	Fits 12, 18 & 22 qt.
LIST PRICE EACH	\$ 3.70	\$ 4.60	\$ 6.70

Case Pack: 6 Colors: Translucent (190), Allergen Free Purple (441). InStock Color: Translucent (190).



See Allergen Free Lids.

Note: All graduations are approximate.

*Seal Covers fit Camwear CamSquare containers only and are not airtight.

**Dimensions include handles.



CAMSQUARE® FOOD STORAGE CONTAINERS



Translucent

- Translucent material provides some content visibility and high chemical resistance.
- Withstands temperatures from -40° to 160°F (-40° to 70°C).
- Easy to read graduations are printed on the outside for at a glance inventory management.

Note: All graduations are approximate.



Poly

- Economical storage choice.
- Made of impact, stain and chemical resistant opaque material.
- Withstands temperatures from -40° to 160°F (-40° to 70°C).

Note: All graduations are approximate.



Covers for Camwear®, Translucent and Poly CamSquares

- Snap-tight polyethylene covers feature thumb tabs for easy removal.
- Colored covers match up with colored graduation marks on containers.



Personalization

Personalize food storage products to identify menu items, add fill lines for recipes, or use personalization in multiple languages to help ensure product quality and consistency.

For more information see the "Promote Your Brand" page located in the Table section of this catalog.



CAMSQUARE® FOOD STORAGE CONTAINERS



Translucent



CODE	2SFSP	4SFSP	6SFSP	8SFSP	12SFSP**	18SFSP**	22SFSP**
CAPACITY	2 qt.	4 qt.	6 qt.	8 qt.	12 qt.	18 qt.	22 qt.
DIM. L x W x H	7¼" x 7¼" x 3⅞"	7¼" x 7¼" x 7⅝"	8⅝" x 8⅝" x 7¼"	8⅝" x 8⅝" x 9⅞"	11¼" x 12¼" x 8¾"	11¼" x 12¼" x 12⅝"	11¼" x 12¼" x 15¾"
LIST PRICE EACH	\$ 7.15	\$ 9.85	\$ 12.20	\$ 14.45	\$ 20.40	\$ 27.75	\$ 34.20

Case Pack: 6 Color/InStock Color: Translucent (190). Height includes covers.

Poly



CODE	2SFSP	4SFSP	6SFSP	8SFSP	12SFSP**	18SFSP**	22SFSP**
CAPACITY	2 qt.	4 qt.	6 qt.	8 qt.	12 qt.	18 qt.	22 qt.
DIM. L x W x H	7¼" x 7¼" x 3⅞"	7¼" x 7¼" x 7⅝"	8⅝" x 8⅝" x 7¼"	8⅝" x 8⅝" x 9⅞"	11¼" x 12¼" x 8¾"	11¼" x 12¼" x 12⅝"	11¼" x 12¼" x 15¾"
LIST PRICE EACH	\$ 6.80	\$ 9.25	\$ 11.55	\$ 13.65	\$ 19.45	\$ 26.30	\$ 32.15

Case Pack: 6 Color: Natural White (148). Height includes covers.

Universal Covers*



CODE	SFC2	SFC6	SFC12
COLOR	Kelly Green (452)	Winter Rose (451)	Midnight Blue (453)
DESCRIPTION	Fits 2 & 4 qt.	Fits 6 & 8 qt.	Fits 12, 18 & 22 qt.
LIST PRICE EACH	\$ 3.70	\$ 4.60	\$ 6.70

Case Pack: 6 Colors/InStock Colors: Kelly Green (452), Winter Rose (451), Midnight Blue (453).

Note: All graduations are approximate.

*Fit all Camquares.

**Dimensions include handles.



CAMWEAR® ROUND FOOD STORAGE CONTAINERS



Store ingredients or transport ready to serve or partially prepared foods. Clear Camwear allows for easy content identification at a glance. Reduces risk of contamination and enhances food safety. Round shape promotes proper air circulation, ideal for stirring soups and sauces.

Note: All graduations are approximate.
Note: To order Round Food Storage Containers without imprinted graduations, simply add "N" to the end of the code number.
 Lids are not interchangeable.

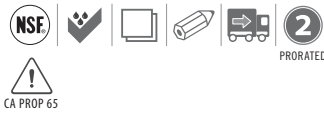

Crystal clear, virtually unbreakable Camwear withstands temperatures from -40° to 210°F (-40° to 99°C).

Molded-in handles ease carrying. Molded-in holes offer quick and sanitary drying.

Resists food acids, oils & alcohol. Stain and odor resistant.

Interstacking saves space when not in use.

Color graduations printed on the outside for quick inventory management.

Camwear Covers

- Snap on covers fit tightly.
- Stain resistant to food acids and oils.
- Withstands temperatures from -40° to 210°F (-40° to 99°C).



Round Seal Covers*

- Inner and outer seal provide excellent spill resistance.
- Safe from -40° to 160°F (-40° to 70°C).
- Thumb tab for easy removal.



*Seal covers only fit Camwear Round Food Storage Containers and are not airtight.

CAMWEAR® ROUND FOOD STORAGE CONTAINERS



Camwear



CODE	RFSCW1	RFSCW2	RFSCW4	RFSCW6	RFSCW8	RFSCW12	RFSCW18	RFSCW22
CAPACITY	1 qt.	2 qt.	4 qt.	6 qt.	8 qt.	12 qt.	18 qt.	22 qt.
DIMENSIONS	Top dia. 6 ¹ / ₁₆ " Height 5"	Top dia. 8 ³ / ₁₆ " Height 4 ³ / ₁₆ "	Top dia. 8 ³ / ₁₆ " Height 8 ³ / ₁₆ "	Top dia. 9 ¹ / ₁₆ " Height 7 ⁵ / ₁₆ "	Top dia. 9 ¹ / ₁₆ " Height 10 ⁷ / ₈ "	Top dia. 14 ¹ / ₈ " Height 8 ³ / ₈ "	Top dia. 14 ¹ / ₈ " Height 12"	Top dia. 14 ¹ / ₈ " Height 15"
CASE PACK	12	12	12	12	12	6	6	6
LIST PRICE EACH	\$ 6.65	\$ 9.20	\$ 15.55	\$ 18.20	\$ 23.05	\$ 32.55	\$ 44.65	\$ 51.40

Color/InStock Color: Clear (135). Top diameter dimension includes handle. Height dimension includes cover. Two year warranty on Camwear rounds.



Camwear Covers

DESCRIPTION	CASE PACK	CODE	LIST PRICE EA.
Fits 1 qt.	12	RFSCWC1	\$ 2.40
Fits 2 & 4	12	RFSCWC2	4.30
Fits 6 & 8	12	RFSCWC6	5.45
Fits 12, 18 & 22	6	RFSCWC12	12.45

Color/InStock Color: Clear (135).



Seal Covers for Camwear Rounds

DESCRIPTION	CASE PACK	CODE	LIST PRICE EA.
Fits 1 qt.	12	RFS1SCPP	\$ 2.20
Fits 2 & 4	12	RFS2SCPP	3.40
Fits 6 & 8	12	RFS6SCPP	3.50
Fits 12, 18 & 22	6	RFS12SCPP	7.50

Color/InStock Color: Translucent (190).

ROUND FOOD STORAGE CONTAINERS

Translucent

- Translucent material offers some product visibility.
- Rounds are durable and resistant to stains.
- Withstands temperatures from -40° to 160°F (-40° to 70°C).
- Snap on covers fit tightly to protect contents and extend product freshness.

Note: All graduations are approximate.
.....
Lids are not interchangeable.
.....



Poly

- Impact, stain and chemical resistant material.
- An affordable storage choice.
- Safe from -40° to 160°F (-40° to 70°C).
- Snap on covers fit tightly yet are easily removed.

Note: All graduations are approximate.
.....

Note: To order Round Food Storage Containers without imprinted graduations, simply add "N" to the end of the code number.
.....

Lids are not interchangeable.
.....



ROUND FOOD STORAGE CONTAINERS



Translucent



CODE	RFS1PP	RFS2PP	RFS4PP	RFS6PP	RFS8PP	RFS12PP	RFS18PP	RFS22PP
CAPACITY	1 qt.	2 qt.	4 qt.	6 qt.	8 qt.	12 qt.	18 qt.	22 qt.
DIMENSIONS	Top dia. 6 ¹ / ₁₆ " Height 5"	Top dia. 8 ³ / ₁₆ " Height 4 ¹ / ₁₆ "	Top dia. 8 ³ / ₁₆ " Height 8 ¹ / ₁₆ "	Top dia. 9 ¹⁵ / ₁₆ " Height 7 ¹⁵ / ₁₆ "	Top dia. 9 ¹⁵ / ₁₆ " Height 10 ¹ / ₈ "	Top dia. 14 ⁷ / ₈ " Height 8 ³ / ₈ "	Top dia. 14 ⁷ / ₈ " Height 12"	Top dia. 14 ⁷ / ₈ " Height 15"
CASE PACK	12	12	12	12	12	6	6	6
LIST PRICE EACH	\$ 4.60	\$ 5.10	\$ 5.90	\$ 7.15	\$ 9.55	\$ 17.00	\$ 20.60	\$ 24.20

Color/InStock Color: Translucent (190). Top diameter dimension includes handle. Height dimension includes cover.

Poly



CODE	RFS1	RFS2	RFS4	RFS6	RFS8	RFS12	RFS18	RFS22
CAPACITY	1 qt.	2 qt.	4 qt.	6 qt.	8 qt.	12 qt.	18 qt.	22 qt.
DIMENSIONS	Top dia. 6 ¹ / ₁₆ " Height 5"	Top dia. 8 ³ / ₁₆ " Height 4 ¹ / ₁₆ "	Top dia. 8 ³ / ₁₆ " Height 8 ¹ / ₁₆ "	Top dia. 9 ¹⁵ / ₁₆ " Height 7 ¹⁵ / ₁₆ "	Top dia. 9 ¹⁵ / ₁₆ " Height 10 ¹ / ₈ "	Top dia. 14 ⁷ / ₈ " Height 8 ³ / ₈ "	Top dia. 14 ⁷ / ₈ " Height 12"	Top dia. 14 ⁷ / ₈ " Height 15"
CASE PACK	12	12	12	12	12	6	6	6
LIST PRICE EACH	\$ 4.45	\$ 4.80	\$ 5.45	\$ 6.80	\$ 8.90	\$ 15.95	\$ 19.35	\$ 22.80

Color: Natural White (148). Top diameter dimension includes handle. Height dimension includes cover.

Covers for Translucent Rounds

DESCRIPTION	CASE PACK	CODE	LIST PRICE EA.
Fits 1 qt.	12	RFSC1PP	\$ 1.70
Fits 2 & 4	12	RFSC2PP	1.75
Fits 6 & 8	12	RFSC6PP	2.50
Fits 12, 18 & 22	6	RFSC12PP	5.80

Color/InStock Color: Translucent (190).

Covers for Poly Rounds

DESCRIPTION	CASE PACK	CODE	LIST PRICE EA.
Fits 1 qt.	12	RFSC1	\$ 1.50
Fits 2 & 4	12	RFSC2	1.55
Fits 6 & 8	12	RFSC6	2.20
Fits 12, 18 & 22	6	RFSC12	5.30

Color: Natural White (148).

CAMWEAR® FOOD STORAGE BOXES

Extend the freshness of ingredients and eliminate points of cross contamination by transferring product into food boxes at the receiving dock. A safe solution for storing bulk fruits and vegetables. Clear Camwear allows visibility for product identification. Snap tight Camwear Flat Lids or SlidingLids, sold separately, remain in place and won't come off during transport.

SlidingLids are covered by the following U.S. Patents D 447,906 S & 6,540,098 B1.



Available in Safety Red or Yellow to reduce the risk of cross contamination.

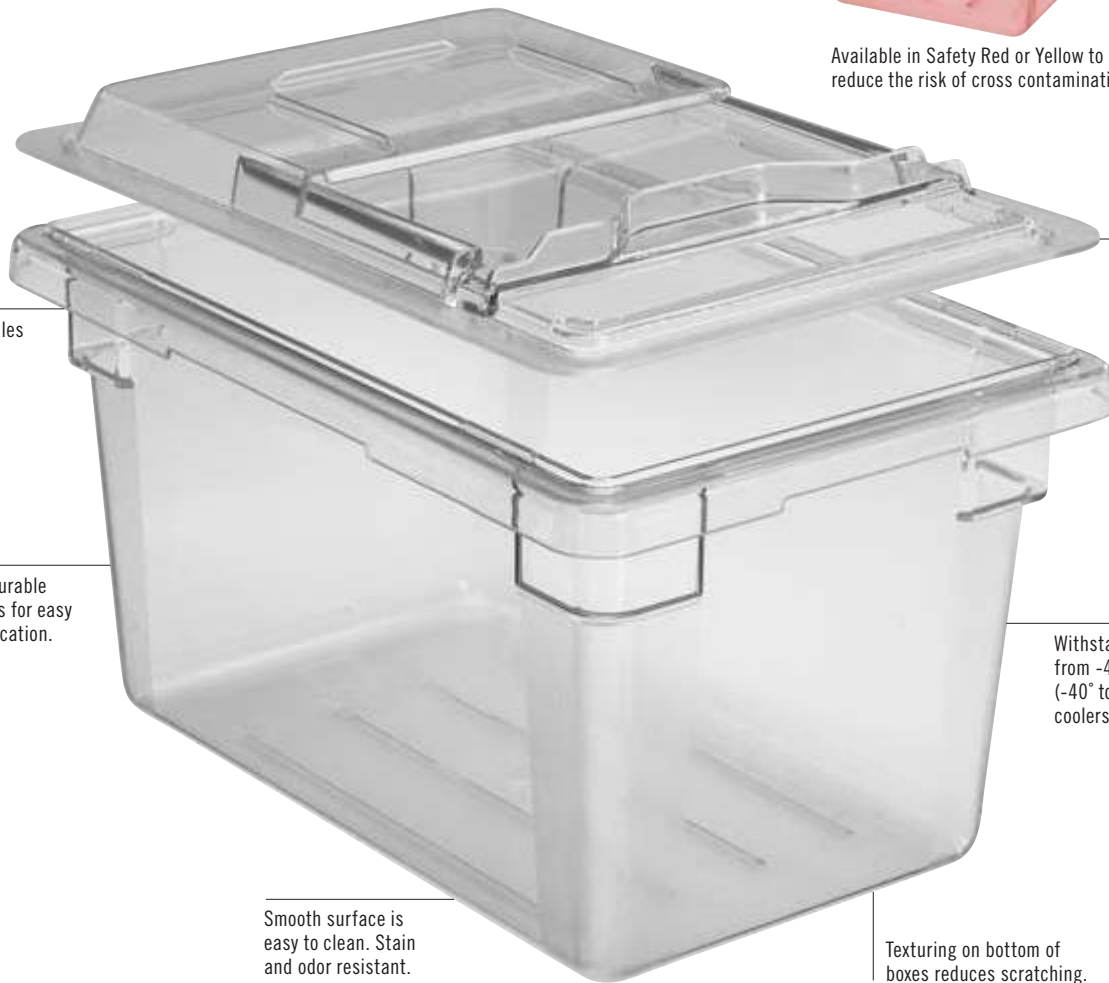

Molded-in handles ease carrying.

SlidingLid provides easy access to contents without removing the lid.

Crystal clear, durable Camwear allows for easy product identification.

Withstands temperatures from -40° to 210°F (-40° to 99°C) for use in coolers and freezers.

Smooth surface is easy to clean. Stain and odor resistant.

Texturing on bottom of boxes reduces scratching.

Camwear Flat Lids

- Snap-tight covers won't come off during transport.
- Top molded-in rails for safer, more secure stacking.
- Durable Camwear is safe from -40° to 210°F (-40° to 99°C).

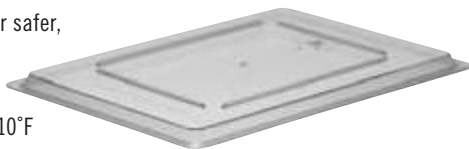

Camwear SlidingLids™

- Lid slides back to easily access contents, minimizing handling.
- Reduces the risk of cross contamination since lid remains on food box.
- Made of virtually unbreakable Camwear.



CAMWEAR® FOOD STORAGE BOXES



Camwear Food Storage Boxes



CODE	18263CW	❖● 18266CW	18269CW
DIMENSIONS	18" x 26" x 3½"	18" x 26" x 6"	18" x 26" x 9"
APPROX. CAPACITY	5 gal.	8.75 gal.	13 gal.
CASE PACK	6	6	4
LIST PRICE EACH	\$ 44.00	\$ 57.00	\$ 75.00

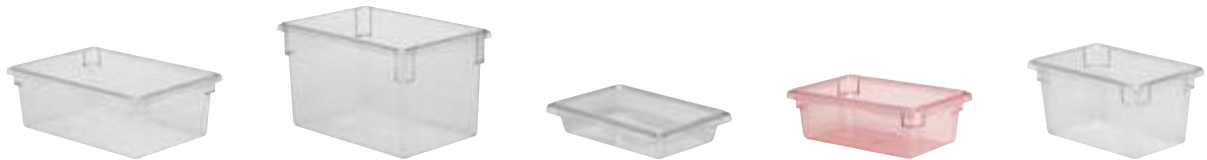

CODE	182612CW	182615CW	12183CW	❖● 12186CW	❖● 12189CW
DIMENSIONS	18" x 26" x 12"	18" x 26" x 15"	12" x 18" x 3½"	12" x 18" x 6"	12" x 18" x 9"
APPROX. CAPACITY	17 gal.	22 gal.	1.75 gal.	3 gal.	4.75 gal.
CASE PACK	4	3	6	6	6
LIST PRICE EACH	\$ 91.35	\$ 107.80	\$ 24.10	\$ 30.50	\$ 41.00

Color/InStock Color: Clear (135). 18266CW & 12186CW are available in Safety Yellow & Red.

● Safety Red (467). ❖ Safety Yellow (464). Contact your Cambro representative for pricing information for Safety Red and Yellow.



Camwear Covers



CODE	❖● 1826CCW FLAT LID	1826SCCW SLIDINGLID™	❖● 1218CCW FLAT LID	1218SCCW SLIDINGLID
DIMENSIONS	18" x 26"	18" x 26"	12" x 18"	12" x 18"
LIST PRICE EACH	\$ 29.85	\$ 53.45	\$ 14.90	\$ 31.80

Case Pack: 6 Color/InStock Color: Clear (135). 1826CCW & 1218CCW are available in Safety Yellow & Red.

● Safety Red (467). ❖ Safety Yellow (464). Contact your Cambro representative for pricing information for Safety Red and Yellow.



CAMWEAR® FOOD STORAGE BOX ACCESSORIES

ColanderKit™

- A complete food safety system packaged in one carton.
- Store raw meats, fish on ice or bulk produce safely.
- Juices and liquids drip into the food box below for quick and easy disposal.
- Reduces handling and risk of cross contamination.
- ColanderKit Includes:
 - 1 - 8" Deep Colander
 - 1 - 18" x 26" x 9" Food Box
 - 1 - 18" x 26" SlidingLid™



Camwear Colanders

- Enhances food quality and reduces risk of cross contamination.
- Liquids and juices drain directly into food box for improved food safety.
- Ideal for draining fruits and vegetables, thawing meat or poultry, or storing seafood on ice.
- Fits Camwear 18" x 26" Food Storage Boxes only.



Drain hole dimension: 3/8".

Camwear Drain Shelves

- Lifts contents out of liquids to enhance food quality and freshness.
- Made of virtually unbreakable Camwear.
- Fits Camwear and Poly Boxes.



Accessories

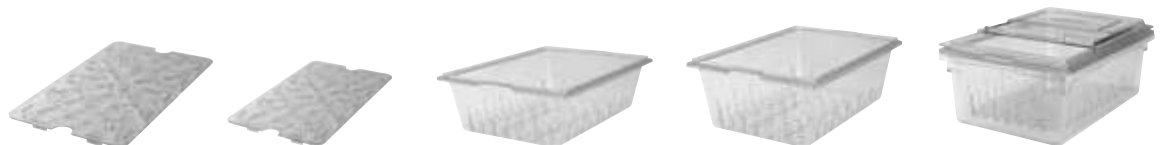

CODE	1826DSCW	1218DSCW	1826CLRCW (5" DEEP)	18268CLRCW (8" DEEP)	18268CLRKIT
DESCRIPTION	Drain shelf	Drain shelf	Colander	Colander	ColanderKit
DIMENSIONS	Fits all 18" x 26" food storage boxes	Fits all 12" x 18" food storage boxes	Fits Camwear food storage boxes only 18" x 26" x 6" and deeper	Fits Camwear food storage boxes only 18" x 26" x 9" and deeper	One 8" deep colander One 18" x 26" x 9" food box One 18" x 26" SlidingLid
CASE PACK	6	6	6	4	1 Kit
LIST PRICE EACH	\$ 24.55	\$ 9.70	\$ 47.15	\$ 81.55	\$ 209.95

Color/InStock Color: Clear (135).



FOOD STORAGE BOXES



Poly Food Storage Boxes

- Economical choice for storing bulk produce and ingredients.
- Impact, stain and chemical resistant material.
- Withstands temperatures from -40° to 160°F (-40° to 70°C).



CODE	18263P	18266P	18269P
DIMENSIONS	18" x 26" x 3½"	18" x 26" x 6"	18" x 26" x 9"
APPROX. CAPACITY	5 gal.	8.75 gal.	13 gal.
CASE PACK	6	6	6
LIST PRICE EACH	\$ 33.00	\$ 43.30	\$ 56.50



CODE	182612P	182615P	12183P	12186P	12189P
DIMENSIONS	18" x 26" x 12"	18" x 26" x 15"	12" x 18" x 3½"	12" x 18" x 6"	12" x 18" x 9"
APPROX. CAPACITY	17 gal.	22 gal.	1.75 gal.	3 gal.	4.75 gal.
CASE PACK	4	3	6	6	6
LIST PRICE EACH	\$ 68.50	\$ 80.60	\$ 19.95	\$ 24.85	\$ 32.85

Color/InStock Color: Natural White (148).

Poly Covers



CODE	1826CP FLAT LID	1218CP FLAT LID
DIMENSIONS	18" x 26"	12" x 18"
LIST PRICE EACH	\$ 25.45	\$ 15.30

Camwear and Poly Lids are not interchangeable.

Case Pack: 6 Color/InStock Color: Natural White (148).

Camchiller®

- Extend cold holding time or enhance safe holding below 41°F when frequent access is required.

CODE	CP814 (8 x 14 CAMCHILLER)
FITS INTO FOOD BOXES	12189CW, 12189P, 12186CW, 12186P
DIMENSIONS L x W x H	14" x 8" x 1½"
LIST PRICE EACH	\$ 73.00

Case Pack: 1 Color/InStock Color: Cold Blue (159).



STORESAFE® FOOD ROTATION LABELS

- Label and adhesive dissolve in less than 30 seconds.
- Leaves behind no sticky residue which can be a breeding ground for bacteria.
- Assists in a proper First In First Out (FIFO) food storage system.
- Run under hot or cold water or through the dishwasher.
- Safe for all sewer and septic systems. Will not build up in drains.
- Withstands high heat temperatures up to 200°F (93°C) for 4 hours. Microwave safe.
- Withstands freezer temperatures up to -40°F (-40°C).

Label color: White.

*Available for ordering in cases only.
No broken cartons.

100% biodegradable.
FDA approved material.



Eliminates sticky residue and prevents cross contamination! No more scraping!



Dissolves completely within 30 seconds off all containers when placed through dishwasher or under running water.



Retail Blister Pack

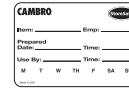

CASE CODE	23SL
LABEL SIZE	2" x 3"
CASE PACK	20 rolls, 100 labels per roll
LIST PRICE CASE	\$ 381.10

StoreSafe Label Blister Pack is covered by U.S. Patent 690,589 S.



Half Size Bulk Dispenser Pack



CASE CODE	1252SLB250	1252SLINB250
LABEL SIZE	1 1/4" x 2"	1 1/4" x 2"
CASE PACK	24 rolls, 250 labels per roll	24 rolls, 250 labels per roll
LIST PRICE CASE	\$ 350.20	\$ 350.20

Bulk Dispenser Pack

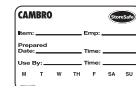
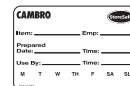

CASE CODE	23SLB250	23SLB6250
LABEL SIZE	2" x 3"	2" x 3"
CASE PACK	24 rolls, 250 labels per roll	6 rolls, 250 labels per roll
LIST PRICE CASE	\$ 705.55	\$ 183.35

Blank Bulk Dispenser Pack



CASE CODE	23SLINB250
LABEL SIZE	2" x 3"
CASE PACK	24 rolls, 250 labels per roll
LIST PRICE CASE	\$ 705.55

Laser Sheet



CASE CODE	SLL30
LABEL SIZE	1" x 2 1/2" (Avery® 5160)
CASE PACK	100 sheets, 30 labels per sheet 8 1/2" x 11" sheet size
LIST PRICE CASE	\$ 180.25





CAMWEAR® FOOD PANS

Store, transport and serve all in one pan. Camwear food pans are made from durable Camwear that will not crack, bend or dent. Precisely designed to Gastronorm GN specifications, with a large radius bottom to reduce food waste. At half the cost of stainless steel, Camwear pans keep contents as cold as metal pans with less condensation. Pans stack neatly without wedging or sticking.

Colors: Clear (135), White (148), Black (110). Except 18CW and 28CW available in Clear (135) only.

Camwear pans are not recommended for steam table or microwave use. See H-Pan™ section for high heat applications.

Colander Pan is covered by U.S. Patent D 528,376.

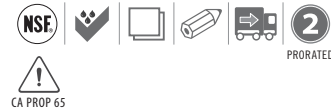

Uniform 1/2" (1,27 cm) flange ensures a smooth fit in prep tables and food bars.

Virtually unbreakable Camwear withstands temperatures from -40° to 210°F (-40° to 99°C).

Molded-in graduations in standard and metric for easy inventory management.

Won't react with food; minimizes potentially hazardous chemical or acidic reaction.

Non-stick smooth interior surface increases yields and promotes easy cleaning.

Textured bottoms resist scratching.



Cold Test

Tests prove Camwear food pans keep products as cold as stainless steel. Stainless may feel colder, but as these test results demonstrate, Camwear food pans keep products just as cold for just as long.

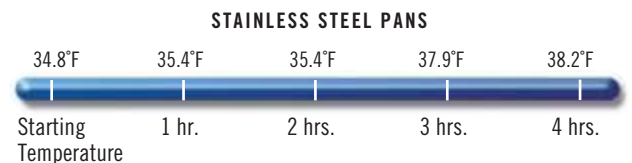
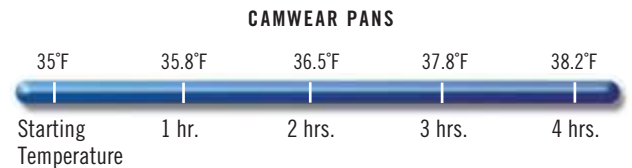

CAMWEAR® FOOD PANS



FULL SIZE

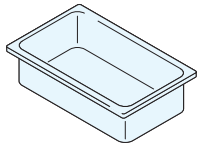

CONFIGURATIONS	PAN CODE	PAN DEPTH	APPROXIMATE CAPACITY	LIST PRICE EA.
GN 1/1 12 ³ / ₄ " x 20 ⁷ / ₈ " (32,5 x 53 cm)	12CW	2 ¹ / ₂ " (6,5 cm)	8.9 qt.	\$ 21.35
	14CW	4" (10)	13.7	27.15
	16CW	6" (15)	20.6	32.95
	18CW	8" (20)	27	39.35
	10CWD	—	Drain shelf	15.50

HALF SIZE LONG

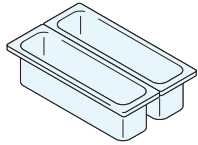

GN 1/2 Long 6 ³ / ₈ " x 20 ⁷ / ₈ " (16,2 x 53 cm)	22LPCW	2 ¹ / ₂ " (6,5)	3.2	16.20
	24LPCW	4" (10)	5.3	20.20
	20LPCWD	—	Drain shelf	8.05

HALF SIZE

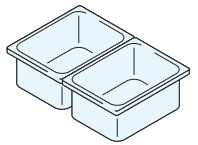

GN 1/2 10 ¹ / ₁₆ " x 12 ³ / ₄ " (26,5 x 32,5 cm)	22CW	2 ¹ / ₂ " (6,5)	4.1	11.85
	24CW	4" (10)	6.3	14.75
	26CW	6" (15)	9.4	18.95
	28CW	8" (20)	12.4	24.10
	20CWD	—	Drain shelf	7.20

ONE THIRD SIZE

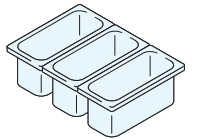

GN 1/3 6 ¹ / ₁₆ " x 12 ³ / ₄ " (17,6 x 32,5 cm)	32CW	2 ¹ / ₂ " (6,5)	2.5	8.90
	34CW	4" (10)	3.8	12.25
	36CW	6" (15)	5.6	14.30
	38CW	8" (20)	7.3	18.30
	30CWD	—	Drain shelf	6.65

QUARTER SIZE

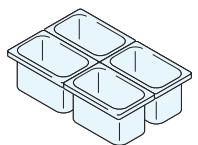

GN 1/4 6 ³ / ₈ " x 10 ¹ / ₁₆ " (16,2 x 26,5 cm)	42CW	2 ¹ / ₂ " (6,5)	1.8	9.00
	44CW	4" (10)	2.7	10.60
	46CW	6" (15)	3.9	12.25
	40CWD	—	Drain shelf	5.55

ONE SIXTH SIZE

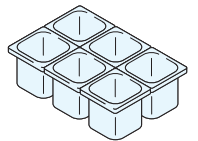

GN 1/6 6 ³ / ₈ " x 6 ¹ / ₁₆ " (16,2 x 17,6 cm)	62CW	2 ¹ / ₂ " (6,5)	1.1	6.55
	64CW	4" (10)	1.6	7.40
	66CW	6" (15)	2.4	9.90
	60CWD	—	Drain shelf	2.95

ONE EIGHTH SIZE

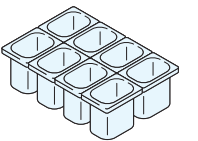

GN 1/8 6 ⁵ / ₁₆ " x 5 ³ / ₁₆ " (16,12 x 13,17 cm)	82CW*	2 ¹ / ₂ " (6,5)	0.7	6.60
	84CW	4" (10)	1.1	7.75
	86CW	6" (15)	1.5	10.25
	80CWD	—	Drain shelf	2.60

ONE NINTH SIZE

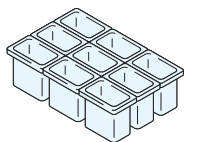

GN 1/9 4 ¹ / ₄ " x 6 ¹ / ₁₆ " (10,8 x 17,6 cm)	92CW	2 ¹ / ₂ " (6,5)	0.6	6.65
	94CW	4" (10)	0.9	8.10
	96PCW	6" (15)	1.4	10.15
	90CWD	—	Drain shelf	2.25

Case Pack: 6.
InStock Color: Clear (135).
96PCW InStock Color: Clear (135), Black (110).

Colors: Clear (135), White (148), Black (110). *82CW is not available in Black (110). 18CW, 28CW and Drain Shelves available in Clear (135) only.

All Camwear food pans are made of FDA approved materials. All Camwear food pans are designed to CEN Gastronorm Standard EN 631-1.



Drain Shelves

- Keeps products out of liquids and promotes drainage.
- Available for all food pan sizes.



96PCW

CAMWEAR® FOOD PAN LIDS



Flat Cover

Available in all pan sizes.



Cover with Handle

Deep molded handle provides secure grip and also includes a peg hole for sanitary drying. Available in black to help block light, reducing discoloration of meats and cheeses.



Notched Cover with Handle

Notched cover allows utensils to remain in pan and off of potentially contaminated counters. Includes peg hole for sanitary drying.



Seal Cover

Designed to fit Camwear and translucent food pans, Seal Covers feature an inner seal that provides superior spill resistance and extends shelf life up to 3 days.



FlipLid®

Flip up lid to easily access contents. Food can be held without getting dried out, increasing yields. Reduces points of cross contamination.



Notched FlipLid

FlipLid with notch to rest spoon in contents with lid closed.



GripLid®

Molded-in polyurethane gasket on the lid grips the side of the food pan airtight, reducing spills and points of cross contamination.



FITS PAN	LID CODE	DESCRIPTION	LIST PRICE EA.
GN 1/1 12 ³ / ₄ " x 20 ⁷ / ₈ " (32,5 x 53 cm)	10CWC	Flat cover	\$ 18.00
	10CWCH*	Cover with handle	18.00
	10CWCHN*	Notched cover w/handle	18.00
	10CWGL	GripLid	37.95
	10PPCWSC	Seal cover	12.30
GN 1/2 Long 6 ³ / ₈ " x 20 ⁷ / ₈ " (16,2 x 53 cm)	20LPCWC	Flat cover	13.80
GN 1/2 10 ¹ / ₁₆ " x 12 ³ / ₄ " (26,5 x 32,5 cm)	20CWC	Flat cover	9.40
	20CWCH*	Cover with handle	9.40
	20CWCHN*	Notched cover w/handle	11.00
	20CWL	FlipLid	14.85
	20CWLN	Notched FlipLid	14.85
	20CWGL	GripLid	26.35
	20PPCWSC	Seal cover	7.50
GN 1/3 6 ¹⁵ / ₁₆ " x 12 ³ / ₄ " (17,6 x 32,5 cm)	30CWC	Flat cover	6.90
	30CWCH*	Cover with handle	6.90
	30CWCHN*	Notched cover w/handle	9.40
	30CWL	FlipLid	12.70
	30CWLN	Notched FlipLid	12.70
	30CWGL	GripLid	18.15
30PPCWSC	Seal cover	5.65	
GN 1/4 6 ³ / ₈ " x 10 ¹ / ₁₆ " (16,2 x 26,5 cm)	40CWC	Flat cover	6.25
	40CWCH*	Cover with handle	6.25
	40CWCHN*	Notched cover w/handle	6.25
	40PPCWSC	Seal cover	5.00
GN 1/6 6 ³ / ₈ " x 6 ¹⁵ / ₁₆ " (16,2 x 17,6 cm)	60CWC	Flat cover	4.90
	60CWCH*	Cover with handle	5.40
	60CWCHN*	Notched cover w/handle	5.40
	60CWL	FlipLid	7.20
	60CWLN	Notched FlipLid	7.20
	60CWGL	GripLid	14.90
	60PPCWSC	Seal cover	3.85
GN 1/8 6 ⁵ / ₁₆ " x 5 ³ / ₁₆ " (16,12 x 13,17 cm)	80CWC	Flat cover	5.20
	80CWCH	Cover with handle	5.70
	80CWCHN	Notched cover with handle	5.70
	80PPCWSC	Seal cover	3.70
GN 1/9 4 ¹ / ₄ " x 6 ¹⁵ / ₁₆ " (10,8 x 17,6 cm)	90CWC	Flat cover	5.50
	90CWCN	Flat notched cover	5.50
	90PPCWSC	Seal cover	3.45

Case Pack for all Lids: 6 InStock Color: Clear (135).

*Includes peg hole.

Color: Clear (135).

Seal Cover Color: Translucent (190).

Cover with Handle Colors: Clear (135),

Black (110).

FlipLids are covered by U.S. Patent D 420,849, D 422,838 & D 427,012.

GripLids are covered by U.S. Patent D 446,076 & Utility Patent 6,273,288 B1.



CAMWEAR® COLANDER PANS



- Rinse, drain and store all in one pan.
- Liquids drain easily into the food pan below for enhanced food quality and reduced handling.
- Colanders simply lift out of the food pan for safe and quick disposal of liquids.
- Ideal for prepped produce, storing seafood on ice, and defrosting and storing meats and poultry.
- Camwear flat covers, covers with handles and notched covers with handles fit on pans with colanders.

Colander Pans are covered by U.S. Patent D 569,169 S.



Drain hole dimension: 1/4".

13CLRCW with 14CW Food Pan.



Rinse



Drain



Store

CONFIGURATIONS	PAN CODE	COLANDER DEPTH	FITS CAMWEAR PAN DEPTH	LIST PRICE EA.
GN 1/1 12 ³ / ₄ " x 20 ⁷ / ₈ " (32,5 x 53 cm)	13CLRCW	3" (7,6 cm)	4" (10 cm)	\$ 27.15
	15CLRCW	5" (12,7)	6" (15)	32.95
GN 1/2 10 ⁷ / ₁₆ " x 12 ³ / ₄ " (26,5 x 32,5 cm)	23CLRCW	3" (7,6)	4" (10)	14.75
	25CLRCW	5" (12,7)	6" (15)	18.95
GN 1/3 6 ¹⁵ / ₁₆ " x 12 ³ / ₄ " (17,6 x 32,5 cm)	33CLRCW	3" (7,6)	4" (10)	12.25
	35CLRCW	5" (12,7)	6" (15)	14.30
GN 1/6 6 ³ / ₈ " x 6 ¹⁵ / ₁₆ " (16,2 x 17,6 cm)	63CLRCW	3" (7,6)	4" (10)	7.40
	65CLRCW	5" (12,7)	6" (15)	9.90

Case Pack: 6 Color: Clear (135). Lids listed on previous page.



H-PAN™ HIGH HEAT FOOD PANS

Reduce handling and save expense with one pan that can go from prep to cooler to oven to steam table. H-Pans are designed to Gastronorm GN specifications. Unlike metal pans, H-Pans are safe for use in heating and holding applications. Ideal for heated carts, steam tables and chafing dishes. H-Pans have both standard and metric graduation markings to promote easy inventory management.

Colors: Amber (150), Black (110).
Drain Shelf Color: Amber (150).

H-Pans are made of FDA approved material and are designed to CEN Gastronorm Standard EN 631-1. Amber color may vary.

Microwave safe.



Uniform 1/2" (1,27 cm) flange ensures a smooth fit in prep tables and food bars.

Cool to the touch for easy handling.

Great for flash freezing and reheating.

Pans stack neatly, without wedging or sticking.



Made from FDA approved material that withstands temperatures from -40° to 375°F (-40° to 190°C).

Non-stick smooth interior surface increases yields and promotes easy cleaning.



H-PAN™ HIGH HEAT FOOD PANS



FULL SIZE

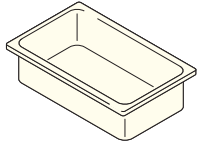

CONFIGURATIONS	PAN CODE	PAN DEPTH	APPROXIMATE CAPACITY	LIST PRICE EA.
GN 1/1 12¾" x 20⅞" (32,5 x 53 cm)	12HP	2½" (6,5 cm)	8.9 qt.	\$ 64.10
	14HP	4" (10)	13.7	77.55
	16HP	6" (15)	20.6	100.80
	10HPD	—	Drain shelf	42.45

Colors: Amber (150), Black (110).
Drain Shelf Color: Amber (150).

H-Pans are made of FDA approved material and are designed to CEN Gastronorm Standard EN 631-1. Amber color may vary.

Microwave safe.



HALF SIZE LONG

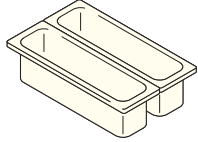

GN 1/2 Long 6⅞" x 20⅞" (16,2 x 53 cm)	22LPHP	2½" (6,5)	3.2	45.60
	24LPHP	4" (10)	5.3	56.70
	20LPHPD	—	Drain shelf	21.20

HALF SIZE

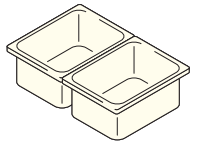

GN 1/2 10⅞" x 12¾" (26,5 x 32,5 cm)	22HP	2½" (6,5)	4.1	31.95
	24HP	4" (10)	6.3	41.55
	26HP	6" (15)	9.4	53.25
	20HPD	—	Drain shelf	19.05

Drain Shelf

- Supports product and promotes drainage.
- Available to fit all food pan sizes.

ONE THIRD SIZE

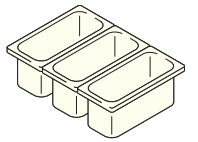

GN 1/3 6⅞" x 12¾" (17,6 x 32,5 cm)	32HP	2½" (6,5)	2.5	26.75
	34HP	4" (10)	3.8	34.65
	36HP	6" (15)	5.6	47.15
	30HPD	—	Drain shelf	14.30

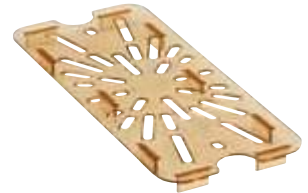

QUARTER SIZE

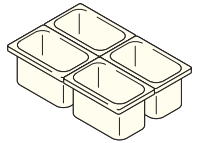

GN 1/4 6⅞" x 10⅞" (16,2 x 26,5 cm)	42HP	2½" (6,5)	1.8	23.15
	44HP	4" (10)	2.7	28.60
	46HP	6" (15)	3.9	36.65
	40HPD	—	Drain shelf	14.30



ONE SIXTH SIZE

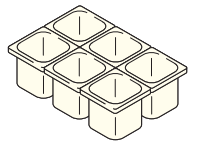

GN 1/6 6⅞" x 6⅞" (16,2 x 17,6 cm)	62HP	2½" (6,5)	1.1	18.10
	64HP	4" (10)	1.6	21.85
	66HP	6" (15)	2.4	26.50
	60HPD	—	Drain shelf	7.35

ONE EIGHTH SIZE

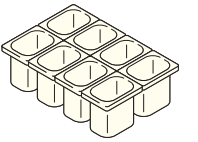

GN 1/8 6⅞" x 5⅞" (16,12 x 13,17 cm)	82HP	2½" (6,5)	0.7	15.85
	84HP	4" (10)	1.1	20.05
	86HP	6" (15)	1.5	25.85
	80HPD	—	Drain shelf	6.45



86HP
Shown with Optional Drain Shelf.

ONE NINTH SIZE

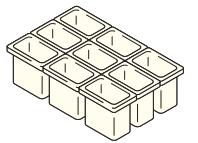

GN 1/9 4¼" x 6⅞" (10,8 x 17,6 cm)	92HP	2½" (6,5)	0.6	13.70
	94HP	4" (10)	0.9	16.00
	96PHP	6" (15)	1.4	22.75
	90HPD	—	Drain shelf	5.45

Case Pack: 6 InStock Color: Amber (150).

H-PAN™ HIGH HEAT FOOD PAN LIDS



Flat Cover

Available in all pan sizes.



FITS PAN	LID CODE	DESCRIPTION	LIST PRICE EA.
GN 1/1 12 ³ / ₄ " x 20 ⁷ / ₈ " (32,5 x 53 cm)	10HPC*	Flat cover	\$ 57.55
	10HPCH*	Cover with handle	57.55
	10HPCHN*	Notched cover w/handle	57.60

GN 1/2 Long 6 ³ / ₈ " x 20 ⁷ / ₈ " (16,2 x 53 cm)	20LPHPC	Flat cover	34.35
---	---------	------------	-------

Cover with Handle

Deep molded handle gives secure grip.

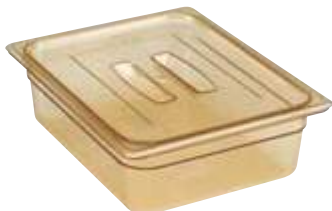

GN 1/2 10 ¹ / ₄ " x 12 ³ / ₄ " (26,5 x 32,5 cm)	20HPC*	Flat cover	25.05
	20HPCH*	Cover with handle	26.55
	20HPCHN*	Notched cover w/handle	30.45
	20HPL	FlipLid	44.10
	20HPLN	Notched FlipLid	44.10

Notched Cover with Handle

Easy access for ladles or spoons.

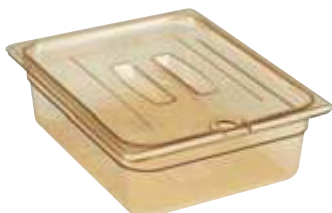

GN 1/3 6 ¹⁵ / ₁₆ " x 12 ³ / ₄ " (17,6 x 32,5 cm)	30HPC*	Flat cover	18.70
	30HPCH*	Cover with handle	21.10
	30HPCHN*	Notched cover w/handle	21.10
	30HPL	FlipLid	31.50
	30HPLN	Notched FlipLid	31.50

GN 1/4 6 ³ / ₈ " x 10 ⁷ / ₁₆ " (16,2 x 26,5 cm)	40HPC	Flat cover	15.20
	40HPCH	Cover with handle	16.35
	40HPCHN	Notched cover w/handle	16.55

FlipLid®

Flip up lid to easily access contents. Food can be held without getting dried out, increasing yields.



GN 1/6 6 ³ / ₈ " x 6 ¹⁵ / ₁₆ " (16,2 x 17,6 cm)	60HPC*	Flat cover	13.25
	60HPCH*	Cover with handle	13.25
	60HPCHN*	Notched cover w/handle	13.25
	60HPL	FlipLid	18.05
	60HPLN	Notched FlipLid	18.05

GN 1/8 6 ⁵ / ₁₆ " x 5 ⁵ / ₁₆ " (16,12 x 13,17 cm)	80HPC	Flat cover	11.15
	80HPCH	Cover with handle	11.15
	80HPCHN	Notched cover w/handle	11.15

Notched FlipLid®

FlipLid with notch to rest spoon in contents with lid closed.



GN 1/9 4 ¹ / ₄ " x 6 ¹⁵ / ₁₆ " (10,8 x 17,6 cm)	90HPC*	Flat cover	9.10
---	--------	------------	------

Case Pack: 6 InStock Color: Amber (150).

*Includes peg hole.

Color: Amber (150).
Amber color may vary.

Microwave safe.

FlipLids are covered by U.S. Patent
D 420,849, D 422,838 & D 427,012 &
Patent 6,273,288 B1.



H-PAN™ HIGH HEAT COLANDER PANS

- Colanders drain liquids and grease away from hot foods, improving food quality.
- Ideal for reheating in microwaves and holding applications such as steam tables and buffet lines.
- Reduces handling and improves food safety.
- H-Pan High Heat Flat Covers, Covers with Handles and Notched Covers with Handles fit on pans with colanders.



Microwave/Steam



Hold Hot Foods



Drain

CONFIGURATIONS	PAN CODE	COLANDER DEPTH	FITS H-PAN DEPTH	LIST PRICE EA.
GN 1/1 12 ³ / ₄ " x 20 ⁷ / ₈ " (32,5 x 53 cm)	13CLRHP	3" (7,6 cm)	4" (10 cm)	\$ 77.55
	15CLRHP	5" (12,7)	6" (15)	100.80
GN 1/2 10 ⁷ / ₁₆ " x 12 ³ / ₄ " (26,5 x 32,5 cm)	23CLRHP	3" (7,6)	4" (10)	41.55
	25CLRHP	5" (12,7)	6" (15)	53.25
GN 1/3 6 ¹⁵ / ₁₆ " x 12 ³ / ₄ " (17,6 x 32,5 cm)	33CLRHP	3" (7,6)	4" (10)	34.65
	35CLRHP	5" (12,7)	6" (15)	47.15
GN 1/6 6 ³ / ₈ " x 6 ¹⁵ / ₁₆ " (16,2 x 17,6 cm)	63CLRHP	3" (7,6)	4" (10)	21.85
	65CLRHP	5" (12,7)	6" (15)	26.50

Case Pack: 6 Color: Amber (150). Lids listed on previous page.



HIGH HEAT H-PAN™ WITH HANDLE(S)

- Flat base to maximize contact with heating element.
- High heat material withstands temperatures from -40° to 375°F (-40° to 190°C).
- Fits all leading manufacturer's product holding units (PHU), including single-sided and pass-through models.
- Reinforced textured handle design with finger grip feature for a secure grasp.
- Handle designed with drain holes to avoid water build-up after warewashing process.
- Two handles allow employees to reach the pan from either side of the unit for safe handling.
- Can be used with high heat lids and drain shelves.

Color: Amber (150).

32HP2H is covered by U.S. Patent D797,493 S.



32HP2H



32HP1H

CONFIGURATIONS	PAN CODE	DESCRIPTION	PAN DEPTH	APPROX. CAPACITY	LIST PRICE EA.
1/3 6 ¹ / ₁₆ " x 12 ³ / ₄ " (17,6 x 32,5 cm)	32HP1H	Single Handle	2 ¹ / ₂ " (6,5 cm)	2.5 qt.	\$ 41.00
	32HP2H	Double Handle	2 ¹ / ₂ " (6,5)	2.5	42.00
Case Pack: 6 Color/InStock Color: Amber (150).					

High Heat Flat Cover,
Cover with Handle and
Notched Cover with Handle
fit on pan.

Full size 2¹/₂" deep food pan with
handles fits all leading product
holding units (PHU).



12HPH

CONFIGURATIONS	PAN CODE	PAN DEPTH	APPROX. CAPACITY	LIST PRICE EA.
1/1 12 ³ / ₄ " x 20 ⁷ / ₈ " (32,5 x 53 cm)	12HPH	2 ¹ / ₂ " (6,5 cm)	8.9 qt.	\$ 73.70
Case Pack: 6 Color/InStock Color: Amber (150). Lids listed on previous page.				

TRANSLUCENT FOOD PANS



- An economical choice for storing food.
- Translucent polypropylene material provides content visibility and high chemical resistance.
- Withstands temperature ranges from -40° to 160°F (-40° to 70°C).
- Meets Gastronorm GN food pan specifications EN-631-1.
- Non-stick smooth interior surface promotes easy cleaning.

Color: Translucent (190).
 Graduation marks and capacities are approximate.
 Translucent food pans are made of FDA approved materials.
 Translucent food pans interstack with other Cambro food pans.
 Translucent pans are not designed for steam table use.



Ideal for transporting in Cambro top loading carriers. (UPC100, UPCS140, 100MPC, UPC140, UPCS160, 240MPC, UPC160, EPP160SW, EPP180SW, EPP260SW, EPP280SW)



Seal covers protect food quality while eliminating the expense of plastic wrap.



Uniform 1/2" (1,27 cm) flange width ensures the right fit in prep tables and food bars.



Use Cambro StoreSafe® food rotation labels on translucent food pans to manage inventory and reduce waste.

TRANSLUCENT COLANDER PANS

- Rinse, drain and store all in one pan.
- Liquids drain easily into the food pan below for enhanced food quality and reduced handling.
- Translucent Cover w/Handle and Notched Cover with Handle fit on pans with colanders.
- Drain hole diameter is approximately 1/4".

Color: Translucent (190).
 Translucent colander pans are made of FDA approved materials.
 Translucent pans are not designed for steam table use.



CONFIGURATIONS	PAN CODE	COLANDER DEPTH	FITS TRANSLUCENT PAN DEPTH	LIST PRICE EA.
GN 1/3 6 ¹⁵ / ₁₆ " x 12 ³ / ₄ " (17,6 x 32,5 cm)	33CLRPP 35CLRPP	3" (7,6 cm) 5" (12,7)	4" (10 cm) 6" (15)	\$ 8.55 9.90
GN 1/6 6 ³ / ₈ " x 6 ¹⁵ / ₁₆ " (16,2 x 17,6 cm)	63CLRPP 65CLRPP	3" (7,6) 5" (12,7)	4" (10) 6" (15)	5.50 6.25

Case Pack for all Pans: 6. Color: Translucent (190). Lids listed on following page.

TRANSLUCENT FOOD PANS

FULL SIZE

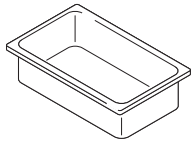

CONFIGURATIONS	PAN CODE	PAN DEPTH	APPROXIMATE CAPACITY	LIST PRICE EA.
GN 1/1 12 ³ / ₄ " x 20 ⁷ / ₈ " (32,5 x 53 cm)	12PP	2 ¹ / ₂ " (6,5 cm)	7.5 qt.	\$ 13.70
	14PP	4" (10)	13.7	17.30
	16PP	6" (15)	20.6	22.15
	18PP	8" (20)	27	29.75
	10PPD	—	Drain shelf	9.85

HALF SIZE

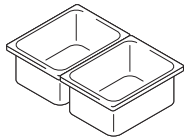

GN 1/2 10 ¹ / ₁₆ " x 12 ³ / ₄ " (26,5 x 32,5 cm)	22PP	2 ¹ / ₂ " (6,5)	4.1	8.40
	24PP	4" (10)	6.3	10.35
	26PP	6" (15)	9.4	13.45
	28PP	8" (20)	12.4	17.70
	20PPD	—	Drain shelf	5.10

ONE THIRD SIZE

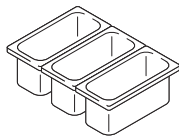

GN 1/3 6 ¹⁵ / ₁₆ " x 12 ³ / ₄ " (17,6 x 32,5 cm)	32PP	2 ¹ / ₂ " (6,5)	2.5	6.30
	34PP	4" (10)	3.8	8.55
	36PP	6" (15)	5.6	9.90
	38PP	8" (20)	7.3	12.80
	30PPD	—	Drain shelf	4.75

QUARTER SIZE

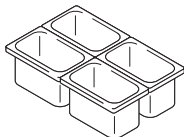

GN 1/4 6 ³ / ₈ " x 10 ⁷ / ₁₆ " (16,2 x 26,5 cm)	42PP	2 ¹ / ₂ " (6,5)	1.8	6.30
	44PP	4" (10)	2.7	7.40
	46PP	6" (15)	3.9	8.55
	40PPD	—	Drain shelf	3.95

ONE SIXTH SIZE

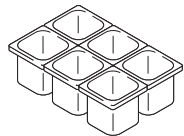

GN 1/6 6 ³ / ₈ " x 6 ¹⁵ / ₁₆ " (16,2 x 17,6 cm)	62PP	2 ¹ / ₂ " (6,5)	1.1	4.85
	64PP	4" (10)	1.6	5.50
	66PP	6" (15)	2.4	7.20
	60PPD	—	Drain shelf	2.65

ONE NINTH SIZE

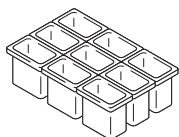

GN 1/9 4 ³ / ₄ " x 6 ¹⁵ / ₁₆ " (10,8 x 17,6 cm)	92PP	2 ¹ / ₂ " (6,5)	0.6	5.10
	94PP	4" (10)	0.9	6.25
	90PPD	—	Drain shelf	1.80

Case Pack: 6 Color/InStock Color: Translucent (190).

Color: Translucent (190).

All translucent food pans are made of FDA approved materials.

All translucent polypropylene GN Food Pans are designed to CEN Gastronorm Standard EN 631-1.



Drain Shelves

- Keeps products out of liquids and promotes drainage.
- Available for all pan sizes.



TRANSLUCENT FOOD PAN LIDS



Seal Cover

Designed to fit Camwear® and translucent food pans, Seal Covers feature an inner seal that provides superior spill resistance and extends shelf life up to 3 days. Available for all food pan sizes.



FITS PAN	LID CODE	DESCRIPTION	LIST PRICE EA.
GN 1/1 12¾" x 20⅞" (32,5 x 53 cm)	10PPCH	Cover with handle	\$ 12.80
	10PPCWSC	Seal cover	12.30

GN 1/2 10⅞" x 12¾" (26,5 x 32,5 cm)	20PPCH	Cover with handle	8.80
	20PPCWSC	Seal cover	7.50

Cover with Handle

Deep molded handle gives secure grip. Available for all food pan sizes except 1/9.



GN 1/3 6⅞" x 12¾" (17,6 x 32,5 cm)	30PPCH	Cover with handle	6.10
	30PPCHN	Notched cover w/handle	7.50
	30PPCWSC	Seal cover	5.65

GN 1/4 6⅞" x 10⅞" (16,2 x 26,5 cm)	40PPCH	Cover with handle	5.90
	40PPCWSC	Seal cover	5.00

Notched Cover with Handle

Easy access for ladles or spoons. Available for 1/3 and 1/6 food pans.



GN 1/6 6⅜" x 6⅞" (16,2 x 17,6 cm)	60PPCH	Cover with handle	5.15
	60PPCHN	Notched cover w/handle	5.60
	60PPCWSC	Seal cover	3.85

Flat Cover

Only available for 1/9 food pans.



GN 1/9 4¼" x 6⅞" (10,8 x 17,6 cm)	90PPC	Flat cover	4.45
	90PPCWSC	Seal cover	3.45

Case Pack: 6 Color/InStock Color: Translucent (190).

Color: Translucent (190).

All translucent food pan lids are made of FDA approved materials.



COLDFEST® GASTRONORM PANS, CROCKS, COVERS & PUMPS



- Keeps contents chilled at or below HACCP guidelines of 41°F (4°C) without the use of messy ice.
- Freeze upside down for eight hours or overnight before filling with pre-chilled product.
- Half and third-size pans hold contents cold for up to eight hours. Sixth size pans and crocks hold contents cold for up to six hours.
- Conforms to Gastronorm exterior dimensions to fit standard food bars or make tables.
- Stackable to save space when freezing and storing.
- Can be used for direct food contact with all types of food products.

Colors: Black (110), White (148).
Flat Cover Color: Clear (135).
Seal Cover Color: White (148).
Pump with Cover Color: Clear (135).

Suggested holding times are based on tests with ambient room conditions of up to 74°F (23°C).

ColdFest is covered under U.S. Patent D 419,364.

*Pumps and Round Covers are Not NSF Listed.



Ideal for use with Cambro Versa Food Bars® to keep perishable items chilled.

Pans / Crock



CODE	26CF	36CF	66CF	CFR18
CONFIGURATIONS	GN 1/2 – 10¼" x 12¾"	GN 1/3 – 6½" x 12¾"	GN 1/6 – 6¾" x 6¾"	Dia. 6½"
DEPTH	6"	6"	6"	6¾"
APPROX. CAPACITY	6.5 qt.	3.7 qt.	1.5 qt.	1.7 qt.
LIST PRICE EACH	\$ 61.65	\$ 46.35	\$ 31.55	\$ 34.25

Case Pack: 1 InStock Color: White (148).



ColdFest Food Pans are made with high-impact resistant ABS shells and non-toxic refrigerant gel cores.

Covers



CODE	20CFC	30CFC	60CFC	CFRC18*	CFRSC18
DESCRIPTION	Flat cover	Flat cover	Flat cover	Flat cover	Seal cover
FITS COLDFEST	GN 1/2	GN 1/3	GN 1/6	Crock	Crock
LIST PRICE EACH	\$ 15.60	\$ 13.05	\$ 6.95	\$ 19.05	\$ 5.65

Case Pack: 2 InStock Color: Clear (135).



Pumps with Clear Covers



CODE	CFPSRC10*	CFPMRC10*	CFPFR10*
DESCRIPTION	Standard pump for 1 oz. portions	Maxi pump for chunky condiments	Fixed nozzle pump for controlled dispensing
DIMENSIONS W x D x H	7¼" x 9" x 11¼"	7¼" x 10¼" x 12¾"	7¼" x 11½" x 11¼"
LIST PRICE EACH	\$ 16.40	\$ 39.00	\$ 38.65

Case Pack: 1



PIZZA DOUGH BOXES AND PIZZA DOUGH BOX CAMDOLLY®



DB18263P

Polypropylene

- Ideal for storing, transporting, proofing and cooling dough.
- Lightweight, durable, and break resistant.
- Chemical resistant material won't absorb odors and is easy to clean.
- Boxes nest tightly together to keep out dirt and contaminants, extending product freshness.

- Each box acts as a tight lid for the box below, reducing the need and expense of covers.
- Withstands temperatures from -40° to 160°F.*
- Cover can be used as an 18" x 26" tray.
- Available in 3" depth only.

Color: White (148).

Camwear & Polypropylene dough boxes do not inter stack.

*Polypropylene dough boxes are safe for use in high temperature dishwashers.

Camdolly Caster: 5" Casters: 2 fixed, 2 swivel, 1 with brake.



CD1826PDB

Weight Capacity: 300 lbs.



Camwear®

- Prevents crusting to increase the storage life of dough.
- Virtually unbreakable Camwear construction is reinforced on all sides.
- Boxes won't bend or lose their shape.

- Withstands temperatures from -40° to 210°F.
- Available in 3" and 6" depths.



DB18266CW

DB18263CW

CODE	OUTSIDE DIMENSIONS INSIDE DIMENSIONS	CASE PACK	LIST PRICE EA.
Polypropylene Pizza Dough Box			
DB18263P	18" x 26" x 3" 16" x 24"	6	\$ 40.60
Polypropylene Cover			
DBC1826P	18" x 26"	6	27.30
Camwear Pizza Dough Boxes			
DB18263CW	18" x 26" x 3" 16" x 24"	6	49.25
DB18266CW	18" x 26" x 6" 16" x 24"	6	66.20
Camwear Cover			
DBC1826CW	18" x 26"	6	35.90
Camdolly For Pizza Dough Boxes			
CD1826PDB**	19 ¹ / ₁₆ " x 27 ⁷ / ₁₆ " x 10 ¹ / ₄ " 17 ¹ / ₁₆ " x 25 ³ / ₈ "	1	375.95

InStock Color: White (148). **Optional straps (400STP or UTHSTP) sold separately.
Camdolly Colors: Black (110), Charcoal Grey (615), Dark Brown (131), Coffee Beige (157), Slate Blue (401).



INGREDIENT BINS AND CAMWEAR® DRY SCOOPS

Ingredient Bins

- Store bulk dry ingredients such as flour and grain.
- Hygienic clear sliding lid reduces handling and allows for quick content identification.
- Bin made of FDA-accepted material so no liners are needed.
- Designed to fit under standard work tables.

3" Casters: 2 rear fixed, 2 front swivel.

Color: White (148).

Cover Color: Clear (135).

Scoops sold separately.



CODE	DIMENSIONS W x L x H	LIQUID CAPACITY	LID TYPE	DRY CAPACITY (SUGAR)	DRY CAPACITY (FLOUR)	LIST PRICE EA.
IBS20	13" x 29½" x 28"	21 gal.	Two Piece Sliding Lid	170 lbs.	140 lbs.	\$ 386.25
IBS27	16⅝" x 29⅝" x 28"	27	Two Piece Sliding Lid	226	150	396.55
IBS37	21½" x 29½" x 28¼"	37	Two Piece Sliding Lid	314	225	437.75
IBSF27	13" x 30⅝" x 28½"	26.7	Two Piece Sliding Lid	216	150	412.00
IB32	22" x 24" x 23"	32	Single Flat Lid	215	160	427.45
IB36	15¼" x 29½" x 29"	34	Single Flat Lid	252	180	437.75
IB44	18½" x 29½" x 29"	42.5	Single Flat Lid	320	230	442.90

Case Pack: 1 InStock Color: White (148).

Camwear Dry Scoops

- Virtually unbreakable Camwear will not dent, chip or rust.
- Molded-in sure grip handle includes a hole for hanging.
- Ideal for use with Cambro Ice Caddies and Ingredient Bins.

Color: Clear (135).



CODE	APPROX. CAPACITY	CASE PACK	LIST PRICE EA.
SCP6CW	6 oz.	12	\$ 6.70
SCP12CW	12	12	7.25
SCP24CW	24	12	9.20
SCP64CW	64	6	13.10

InStock Color: Clear (135).

SOAK AND BRINE TANK & CAMCRISPER®



Soak and Brine Tank

- Designed for complete submersion of meats or poultry in brining solution for enhanced moisture retention, texture and flavor.
- Can also be used as a pre-soak tank for smallwares and dishes in sanitation solution to help reduce labor in pre-scrubbing.
- Clear sliding lid always stays on to help reduce the risk of cross contamination.
- Withstands temperatures from -40° to 160°F (-40° to 70°C).

3" Casters: 2 rear fixed, 2 front swivel.

Colors: White (148), Yellow (229).
Cover Color: Clear (135).

Some assembly required.



Maneuverable drain elbow can be positioned in any direction as needed. Use with or without drain hose based on available access to floor drain.

Tank drains easily in 4 minutes when completely full and features an easy to turn 45° ball valve.

Maneuverable drain elbow and clear hose allow drainage even with hard to access drains.

CODE	DIMENSIONS W x L x H	CAPACITY	CUBIC FEET	LIST PRICE EA.
IBSD37	21½" x 29½" x 28¼"	37 gal.	5.55	\$ 715.00

Case Pack: 1

Camcrisper

- A self-contained system for brining or storing, washing and transporting bulk produce.
- Prevents cross contamination and minimizes unnecessary handling.
- Transfer dry produce out of cartons into bin, cover and roll into cooler for safe storage.
- Wash and rinse produce for easy and safe prep.

3" Casters: 2 rear fixed, 2 front swivel.

Color: White (148).
Cover Color: Clear (135).



CODE	DIMENSIONS W x L x H	CAPACITY	CUBIC FEET	LOAD CAPACITY	LIST PRICE EA.
CC32	22" x 24" x 23"	32 gal.	4.28	24 lettuce heads (unfinished) 42 lettuce heads (finished)	\$ 638.60

Case Pack: 1

HIGH HEAT MEASURING CUPS AND CAMWEAR® MEASURING CUPS



High Heat Measuring Cups and Cover

- Use to heat liquids or sauces in the microwave, collect hot water from a dispenser, fill steam tables or chafing dishes or rehydrate food products.
- Withstands temperatures ranging from -40° to 375°F (-40° to 190°C).
- Will not crack or shatter from regular use with hot liquids/ ingredients.

- Molded-in standard and metric graduations ensure accuracy and will hold up to the rigors of foodservice.
- Molded-in handle is positioned for both comfort and safety, and stays cool to the touch out of the microwave or oven.
- Optional Splatter-Proof Cover fits both 2 and 4 qt. measuring cups.

Color: Amber (150).



Cups shown with Optional Universal Cover.

CODE	DESCRIPTION	DIMENSIONS W x H	LIST PRICE EA.
200MCH	2 qt. Measuring Cup	6 ³ / ₈ " x 7 ⁷ / ₈ "	\$ 50.00
400MCH	4 qt. Measuring Cup	10 ³ / ₈ " x 7 ⁷ / ₈ "	75.00
MCCH	Universal Cover (fits both cups)	7 ¹ / ₁₆ " x 15 ¹ / ₁₆ "	20.00

Case Pack: 1

Camwear® Liquid Measuring Cups

- Externally marked graduations are molded in and imprinted in red for American standard and blue for metric for easy measurement.
- Durable, virtually unbreakable Camwear will not dent, ensuring an accurate measurement every time.
- Molded-in handle will not break off.

Color: Clear (135).



CODE	CAPACITY	CASE PACK	LIST PRICE EA.
25MCCW	1 cup (dry measure)	12	\$ 6.55
50MCCW	1 pt.	12	12.20
100MCCW	1 qt.	12	13.70
200MCCW	2	12	18.90
400MCCW	4	1	20.50

InStock Color: Clear (135).

ALLERGEN MANAGEMENT



Camwear® CamSquare® Storage Containers and Covers

- Personalized containers include easy-to-identify purple graduations and Allergen-Free imprint on the opposite side.
- Purple Seal Covers feature an inner and outer seal to help keep ingredients safe from cross contamination, even during transport.



Allergen 6 qt. Container: 6SFSCW441
Lid: SFC6SCPP441

Trays

- Protect your customers from the risk of allergenic foods by keeping color coded Allergen-Free trays on hand.



1418 Camtray®
Grape (551).

Liquid Measuring Cups

- Externally marked purple graduations and Allergen-Free logo are imprinted in Allergen purple for easy identification.



100MCCW441

CODE	DESCRIPTION	CASE PACK	LIST PRICE EA.
Allergen-Free Camwear CamSquares			
2SFSCW441	2 qt.	6	\$ 9.40
4SFSCW441	4 qt.	6	14.35
6SFSCW441	6 qt.	6	18.60
8SFSCW441	8 qt.	6	21.85
12SFSCW441	12 qt.	6	29.10
18SFSCW441	18 qt.	6	43.20
22SFSCW441	22 qt.	6	54.75
Allergen-Free CamSquare Seal Covers			
SFC2SCPP441	Fits 2 & 4 qt.	6	3.90
SFC6SCPP441	Fits 6 & 8 qt.	6	4.90
SFC12SCPP441	Fits 12, 18 & 22 qt.	6	7.10
Allergen-Free Trays			
1418	13 ¹⁵ / ₁₆ " x 17 ¹⁵ / ₁₆ "	12	22.10
Allergen-Free Measuring Cups			
25MCCW441	1 Cup (dry measure)	12	7.20
50MCCW441	1 pt.	12	13.40
100MCCW441	1 qt.	12	15.05
200MCCW441	2 qt.	12	20.80
400MCCW441	4 qt.	1	22.85

Color: Allergen-Free Purple (441).



TABLE SERVICE



ALISO® BARWARE, GOBLETS AND DESSERT GLASS

Aliso Barware replicates the look, heft and clarity of glass with durable Camwear®. The smooth seamless appearance makes Aliso Barware a stylish choice for casual dining, outdoor events or poolside service.

- Barware items have large, heavy bases for stability.
- Bases designed for fast draining and complete drying.
- Chill or frost barware without concerns of thermal shock damage.

Color: Clear (135).

Capacities calculated to rim.



CODE	BWM10CW	BWW10CW	BWP14CW	BWB16CW	GB850CW	GB1200CW	DG3CW*
DESCRIPTION	Martini	Wine	Pilsner	Beer mug	Goblet	Goblet	Dessert glass
MAX DIAMETER	4 ¹³ / ₁₆ "	2 ¹⁵ / ₁₆ "	3 ³ / ₄ "	4 ³ / ₄ "	2 ³ / ₄ "	2 ³ / ₄ "	2 ⁷ / ₈ "
MAX HEIGHT	6 ⁷ / ₈ "	6 ³ / ₄ "	9 ⁹ / ₁₆ "	6 ¹ / ₄ "	6 ¹ / ₄ "	7 ⁵ / ₈ "	3"
FULL SIZE CAMRACK®	9S638	25S638	25S958	9S638	36S638	36S738	49S318
CAPACITY TO RIM	10.5 oz.	10.5 oz.	15.5 oz.	16 oz.	9 oz.	12.8 oz.	3.4 oz.
CASE PACK	12	24	24	12	24	24	72
LIST PRICE EACH	\$ 11.65	\$ 9.20	\$ 12.65	\$ 12.15	\$ 4.15	\$ 4.90	\$ 2.35

Color/InStock Color: Clear (135). * Cases only. No broken cartons.

TUMBLERS AND DISPOSABLE CAMLIDS®

- Reusable tumblers save operators the cost of replacing broken glass or disposable kids' cups while reducing waste.
- Reusable tumblers can be personalized with logos or exclusive designs to enhance branding.
- Ideal for fast-paced casual dining or outdoor events. Offers the look of glass without the risk.
- Prevent spills with tight fitting disposable Camlids.



LIDO® TUMBLERS

- Easy to clean internal stacking ring promotes stable and space-efficient storage.
- Made of impact resistant SAN plastic that resists chips and breaks, minimizing replacement costs.

Color: Clear (152).

Lid Color: Translucent (190).

Capacity is to the top fill-line.

Lido Tumblers are covered by U.S. Patent D720,963 S.



*6 oz. and 9 oz. tumblers feature subtle graduation markings intended for use in healthcare operations to measure liquid intake.



CODE	LDT5	LDT6	LDT9	LDT10	LDT12	LDT16	LDT22
FITS LID	CLJ6	CLST6	CL900P	CLNT10	CLNT12	CLST9	CLSM8B5**
DIAMETER	2 ⁵ / ₁₆ "	2 ¹¹ / ₁₆ "	3 ³ / ₁₆ "	2 ⁷ / ₈ "	3"	3 ⁵ / ₁₆ "	3 ¹ / ₂ "
HEIGHT	3 ¹¹ / ₁₆ "	3 ¹¹ / ₁₆ "	3 ¹¹ / ₁₆ "	4 ¹ / ₂ "	4 ¹⁵ / ₁₆ "	5 ⁵ / ₁₆ "	6 ⁵ / ₈ "
FULL SIZE CAMRACK®	49S318	36S318	25S318	36S418	30S434	25S534	20S638
CAPACITY TO RIM	5 oz.	6 oz.*	9 oz.*	10 oz.	12 oz.	16 oz.	22 oz.
CASE PACK TUMBLER / LID	36 / 1,000	36 / 1,000	36 / 1,000	36 / 1,000	36 / 1,000	36 / 1,000	36 / 1,500
TUMBLER LIST PRICE EACH	\$ 1.75	\$ 1.90	\$ 2.20	\$ 2.20	\$ 2.25	\$ 2.70	\$ 3.30
LID PRICE PER CASE	\$ 66.60	\$ 69.60	\$ 97.75	\$ 89.25	\$ 97.75	\$ 97.75	\$ 97.65

**Excludes a cross-slot for straws.

CAMWEAR® HUNTINGTON® AND NEWPORT TUMBLERS

Huntington Tumblers

- Feature the elegant look and feel of glass without the high replacement costs.
- Made of durable Camwear.
- Lightweight.
- Stacking lugs to prevent sticking.
- Three sided drain bottom for easy washing and drying.

Colors: Azure Blue (196), Clear (135).

Lid Color: Translucent (190).

Capacities calculated to rim.

Withstands temperatures from -40° to 210°F.

*Excludes a cross-slot for straws.



CODE	HT5CW	HT8CW	HT10CW	HT120CW	HT12CW	HT14CW	HT16CW	HT22CW
FITS LID	—	CLNT8	—	CLNT12	—	—	CLAM8B5*	CLSM8B5*
MAX DIAMETER	2 ¹¹ / ₃₂ "	2 ¹¹ / ₁₆ "	2 ¹³ / ₁₆ "	3"	3 ³ / ₈ "	3 ¹ / ₄ "	3 ⁵ / ₁₆ "	3 ¹ / ₂ "
MAX HEIGHT	3 ⁹ / ₁₆ "	4 ⁷ / ₁₆ "	4 ¹³ / ₁₆ "	5"	3 ³ / ₄ "	4 ⁷ / ₈ "	5 ¹ / ₂ "	6 ¹¹ / ₁₆ "
FULL SIZE CAMRACK®	49S434	36S418	36S434	25S434	25S418	25S434	25S534	25S638
CAPACITY TO RIM	5 oz.	8 oz.	10 oz.	12 oz.	12 oz.	14 oz.	16 oz.	22 oz.
CASE PACK TUMBLER / LID	36 / —	36 / 1,000	36 / —	36 / 1,000	36 / —	36 / —	36 / 1,500	36 / 1,500
TUMBLER LIST PRICE EACH	\$ 2.58	\$ 2.70	\$ 2.81	\$ 2.94	\$ 2.88	\$ 3.23	\$ 3.76	\$ 4.70
LID PRICE PER CASE	—	\$ 69.60	—	\$ 97.75	—	—	\$ 99.10	\$ 97.65

InStock Color: Clear (135).

Newport Tumblers

- Fluted design features the upscale look of glass with the safety benefits and cost savings of plastic.
- Impact resistant SAN plastic resists chips and breaks.
- Stacking lugs prevent sticking.
- Sani-Rim lip provides a sanitary drinking surface.

Colors: Clear (152), Amber (153), Slate Blue (401).

Lid Color: Translucent (190).

Capacities calculated to rim.

Withstands temperatures from -4° to 185°F.

*Excludes a cross-slot for straws.



CODE	NT5	NT8	NT9	NT10	NT12	NT14	NT16	NT20
FITS LID	CLNT5	CLNT8	CLNT9	CLNT10	CLNT12	—	—	CLSM8B5*
MAX DIAMETER	2 ¹ / ₂ "	2 ¹¹ / ₁₆ "	3 ¹ / ₄ "	2 ¹³ / ₁₆ "	3"	3 ³ / ₈ "	3 ¹ / ₄ "	3 ¹ / ₁₆ "
MAX HEIGHT	3 ¹¹ / ₁₆ "	4"	3 ⁹ / ₁₆ "	4 ⁹ / ₁₆ "	5 ¹ / ₈ "	5"	5 ³ / ₄ "	6 ¹ / ₂ "
FULL SIZE CAMRACK	36S318	36S418	25S318	36S434	25S434	25S434	25S534	25S638
CAPACITY TO RIM	6.4 oz.	8 oz.	9.3 oz.	10 oz.	12.6 oz.	14 oz.	16.4 oz.	22 oz.
CASE PACK TUMBLER / LID	36 / 1,500	36 / 1,000	36 / 1,000	36 / 1,000	36 / 1,000	36 / —	36 / —	36 / 1,500
TUMBLER LIST PRICE EACH	\$ 1.60	\$ 1.65	\$ 1.80	\$ 1.95	\$ 2.05	\$ 2.35	\$ 2.45	\$ 3.00
LID PRICE PER CASE	\$ 110.25	\$ 69.60	\$ 97.75	\$ 89.25	\$ 97.75	—	—	\$ 97.65

InStock Color: Clear (152).

LAGUNA® AND DEL MAR® TUMBLERS

Laguna Tumblers

- Hammered texture hides water spots and scratches.
- Made of impact resistant SAN.
- Lightweight and easy to carry.

Colors: Clear (152), Spanish Green (427).
Lid Color: Translucent (190).

Capacities calculated to rim.

Withstands temperatures from
 -4° to 185°F.

*Excludes a cross-slot for straws.



CODE	LT6	LT8	LT10	LT12	LT14	LT16	LT22
FITS LID	CLLT6	CLLT8	CLLT10	CLLT12	—	CLAM8B5*	—
MAX DIAMETER	2½"	2¾"	2 ¹⁵ / ₁₆ "	3⅝"	3¾"	3 ³ / ₁₆ "	3 ¹¹ / ₁₆ "
MAX HEIGHT	4¼"	4½"	4¾"	5"	5⅝"	5½"	6 ¹ / ₁₆ "
FULL SIZE CAMRACK®	36S418	36S418	30S434	25S434	25S434	25S534	16S534
CAPACITY TO RIM	6 oz.	8 oz.	10 oz.	12 oz.	14 oz.	16 oz.	22 oz.
CASE PACK TUMBLER / LID	36 / 1,500	36 / 2,000	36 / 1,000	36 / 1,000	36 / —	36 / 2,000	36 / —
TUMBLER LIST PRICE EACH	\$ 2.00	\$ 2.15	\$ 2.25	\$ 2.45	\$ 2.60	\$ 2.90	\$ 3.25
LID PRICE PER CASE	\$ 110.25	\$ 141.75	\$ 89.25	\$ 97.75	—	\$ 99.10	—

InStock Color: Clear (152).

Del Mar Tumblers

- Cracked glass look features the lightweight handling of plastic.
- Thick sturdy base and rolled rim edge for added stability.
- Made of impact resistant SAN plastic.

Colors: Clear (152), Ruby Red (156),
 Sapphire Blue (608), Light Amber (609).
Lid Color: Translucent (190).

Capacities calculated to rim.

Del Mar Tumblers are covered by the
 following U.S. Patent D 478,778 S.

Withstands temperatures from
 -4° to 185°F.



CODE	D8	D12	D14	D16	D24
FITS LID	—	—	CLST9	—	—
MAX DIAMETER	2⅝"	2 ¹⁵ / ₁₆ "	3¼"	3 ³ / ₁₆ "	3 ¹ / ₁₆ "
MAX HEIGHT	4 ³ / ₁₆ "	4¾"	4 ³ / ₁₆ "	5 ¹⁵ / ₁₆ "	6 ³ / ₈ "
FULL SIZE CAMRACK	36S418	25S434	25S418	25S534	25S638
CAPACITY TO RIM	8 oz.	12 oz.	14 oz.	16 oz.	24 oz.
CASE PACK TUMBLER / LID	36 / —	36 / —	36 / 1,000	36 / —	36 / —
TUMBLER LIST PRICE EACH	\$ 1.55	\$ 1.65	\$ 2.05	\$ 2.10	\$ 2.70
LID PRICE PER CASE	—	—	\$ 97.75	—	—

InStock Color: Clear (152).

COLORWARE TUMBLERS

- A classic value tumbler ideal for casual dining.
- Textured on the outside to resist scratching.
- Made of impact resistant SAN.
- Interior stacking lugs for easy storing.
- Sani-Rim lip provides a sanitary drinking surface.

Colors: Slate Blue (401), Clear (152), Amber (153), Ruby Red (156).
Lid Color: Translucent (190).

Capacities calculated to rim.

Withstands temperatures from -4° to 185°F.



CODE (72 PACK)	500P	800P	900P	950P	1200P	1600P	2000P	—
CODE (24 PACK)	500P2	800P2	900P2	950P2	1200P2	1600P2	2000P2	3200P2
FITS LID	CLJ6	CL800P	CL900P	CL950P	—	—	—	—
MAX DIAMETER	2¼"	2½"	3⅜"	2¾"	2⅝"	3⅞"	3⅝"	3⅝"
MAX HEIGHT	3⅝"	4"	3¼"	4⅜"	5⅝"	5¼"	6½"	7¼"
FULL SIZE CAMRACK	49S318	36S418	25S318	36S418	25S434	25S534	25S638	16S738
CAPACITY TO RIM	5.2 oz.	7.8 oz.	9.7 oz.	9.8 oz.	12.6 oz.	16.4 oz.	22 oz.	32 oz.
P CODE-CASE PACK	72	72	72	72	72	72	72	—
P2 CODE-CASE PACK	24	24	24	24	24	24	24	24
LID CASE PACK	1,000	1,000	1,000	1,000	—	—	—	—
TUMBLER LIST PRICE EACH - 72 PACK	\$ 1.05	\$ 1.25	\$ 2.15	\$ 1.45	\$ 1.65	\$ 1.95	\$ 2.40	—
TUMBLER LIST PRICE EACH - 24 PACK	\$ 1.10	\$ 1.35	\$ 2.35	\$ 1.60	\$ 1.75	\$ 2.05	\$ 2.60	\$ 3.90
LID PRICE PER CASE	\$ 66.60	\$ 76.55	\$ 97.75	\$ 71.30	—	—	—	—

InStock Color: Clear (152).

Coca-Cola® Tumblers

- Colorware Tumblers featuring the Coca-Cola trademark logo in White.
- Available only to Coca-Cola fountain customers for foodservice use.

Color: Clear (152).

Coca-Cola Logo is imprinted in White only.

These trademarked tumblers may not be resold at retail and are available only for distribution to Coca-Cola Fountain customers for food service use.

Withstands temperatures from -4° to 185°F.



CODE	20CC	32CC
MAX DIAMETER	3⅞"	3⅝"
MAX HEIGHT	6½"	7¼"
FULL SIZE CAMRACK	25S638	16S738
CAPACITY TO RIM	22 oz.	32 oz.
CASE PACK	72	24
LIST PRICE EACH - 72 PACK	\$ 2.80	—
LIST PRICE EACH - 24 PACK	—	\$ 4.25

Camrack® IceExpress Glass Filler

- Dramatically reduces banquet set-up time.
- Fills 25 glasses with ice all at once.
- Reduces breakage and risk of contamination.
- Ice falls directly into glasses with no spills or drips.

CODE	EXTERIOR DIMENSIONS W x D x H	LIST PRICE EA.
25SWGf	20" x 20⅝" x 1¼"	\$ 90.90

Case Pack: 1 Color: Black (110).



CAMWEAR® TUMBLERS AND CAMVIEW® CAMLITERS®

Camwear Tumblers

- The look and feel of glass but made of durable Camwear.
- Textured exterior surface resists scratching.
- Smooth interior promotes easy cleaning.
- Designed with a Sani-Rim lip for sanitary drinking.

Color: Clear (152).

Capacities calculated to rim.

Withstands temperatures from -40° to 210°F.



CODE	500CW	800CW	850CW	950CW	1200CW	1600CW
FITS LID	—	—	—	CLNT10	—	CL900P
MAX DIAMETER	2¼"	2⅝"	3⅜"	2¾"	2⅝"	3⅜"
MAX HEIGHT	3⅝"	3⅞"	3⅜"	4⅜"	5⅝"	5¼"
FULL SIZE CAMRACK®	49S318	36S418	25S418	36S418	25S434	25S534
CAPACITY TO RIM	5.4 oz.	8 oz.	9.1 oz. (Heavy wall)	9.6 oz.	13 oz.	17 oz.
CASE PACK TUMBLER / LID	48 / —	48 / —	48 / —	48 / 1,000	48 / —	48 / 1,000
TUMBLER LIST PRICE EACH	\$ 1.55	\$ 1.90	\$ 4.85	\$ 2.20	\$ 2.50	\$ 3.10
LID PRICE PER CASE	—	—	—	\$ 89.25	—	\$ 97.75

CamView Camlitter Beverage Decanters

- Ideal for serving beverages on buffet lines or table side.
- Spill-proof, snap tight flat lids included to protect content from cross contamination.
- Pour spout lid available to protect content while allowing free pour.
- Light-weight, dent and scratch resistant.
- Made of impact resistant material.
- NSF Listed- Camlitter with Flat Lid.

Color: Clear (135).

Lid Color: White (148).

Personalize with a logo to promote your brand. For information please refer to the Table Service Personalization page.



CODE	CAPACITY	HEIGHT	LIST PRICE EA.
Camlitters with Flat Lids			
WW1500	1½ L	10"	\$ 14.00
WW1000	1	9¾"	10.75
WW500	½	7⅞"	7.95
WW250	¼	6¼"	4.80
Lids			
WW1000LS (Pour spout lid for 1½ L, 1 L and ½ L)			1.00
WW1000L (Replacement lid for 1½ L, 1 L and ½ L)			1.00
WW250L (Replacement lid for ¼ L)			1.00
Case Pack: 12 InStock Color: Clear (135).			



CAMWEAR® PITCHERS

- Lightweight for easy handling.
- Exclusive ice-control contoured lip and pour spout reduce spills.
- Slotted base allows for complete and sanitary drying.

Color: Clear (135). P600CW is also available in Amber (153).

InStock Color: Clear (135).

Capacities calculated to rim.

PC34CW Stackable Pitcher is covered by the following U.S. Patent D 682,002 S.



P320CW, P480CW and P600CW

An industry standard. Broad base for stability, prevents tipping.



P320CW

CAPACITY: 32 oz.

HEIGHT WITH SPOUT: 6¾"

DIAMETER WITH HANDLE: 5¾"

LIST PRICE EACH: \$ 10.70

Case Pack: 6



P480CW

CAPACITY: 48 oz.

HEIGHT WITH SPOUT: 7⅞"

DIAMETER WITH HANDLE: 6¼"

LIST PRICE EACH: \$ 12.90

Case Pack: 6



P600CW

CAPACITY: 60 oz.

HEIGHT WITH SPOUT: 8"

DIAMETER WITH HANDLE: 6¾"

LIST PRICE EACH: \$ 14.05

Case Pack: 6



P60CW

CAPACITY: 60 oz.

HEIGHT WITH SPOUT: 9"

DIAMETER WITH HANDLE: 7¼"

LIST PRICE EACH: \$ 15.75

Case Pack: 6

PL60CW

Laguna® pitcher with hammered texture that hides scratches. Pour liquids from front or ice and liquid from sides. Matching tumblers available.



PL60CW

CAPACITY: 60 oz.

HEIGHT WITH SPOUT: 7⅞"

DIAMETER WITH HANDLE: 6¾"

LIST PRICE EACH: \$ 9.35

Case Pack: 6

PE600CW

Economy and lightweight design. Pour liquids from front or ice and liquid from sides.



PE600CW

CAPACITY: 60 oz.

HEIGHT WITH SPOUT: 7⅞"

DIAMETER WITH HANDLE: 7⅞"

LIST PRICE EACH: \$ 9.35

Case Pack: 6

P64CW

Tapered design and drip-proof spout.



P64CW

CAPACITY: 64 oz.

HEIGHT WITH SPOUT: 9¼"

DIAMETER WITH HANDLE: 7⅞"

LIST PRICE EACH: \$ 15.75

Case Pack: 6

PC64CW

Three position lid can strain ice, free pour or close to protect contents.



PC64CW

CAPACITY: 64 oz.

HEIGHT WITH SPOUT: 9¼" with lid

DIAMETER WITH HANDLE: 7⅞"

LIST PRICE EACH: \$ 20.25

Case Pack: 6

PC34CW

Stackable pitchers and lid with frosted design to hide scratches.



PC34CW

CAPACITY: 34 oz.

HEIGHT WITH SPOUT: 7½" with lid

DIAMETER WITH HANDLE: 6⅞"

LIST PRICE EACH: \$ 9.50

Case Pack: 6

CAMWEAR® DINNERWARE

5 5 YEAR PRORATED WARRANTY
AGAINST BREAKAGE

- Durable Camwear resists stains, odors and scratches.
- Textured surface on salad and dinner plates for long wear.
- Ideal for schools, cafeterias, day care centers and healthcare facilities.
- Mug and stacking cup can be personalized.

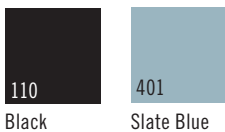

Oval Platters and Compartment Plates



CODE	90SPCW	120CWP	93CW	HK93BCW*
DIAMETER	9" x 1 $\frac{1}{16}$ "	12" x 9"	9"	9 $\frac{1}{2}$ "
DESCRIPTION	Round, soup bowl	Oval, narrow rim	Narrow rim	Heat Keeper base
CASE PACK	48	24	48	12
LIST PRICE EACH	\$ 7.35	\$ 8.40	\$ 7.30	\$ 15.70

*HK93BCW is available in Beige (133) only.

Plates



CODE	10CWNR	9CWNR	825CWNR	725CWNR	65CWNR	55CWNR
DIAMETER	10"	9"	8 $\frac{1}{4}$ "	7 $\frac{1}{4}$ "	6 $\frac{1}{16}$ "	5 $\frac{1}{2}$ "
DESCRIPTION	Narrow rim	Narrow rim	Narrow rim	Narrow rim	Narrow rim	Narrow rim
CASE PACK	48	48	48	48	48	48
LIST PRICE EACH	\$ 6.90	\$ 5.00	\$ 5.20	\$ 4.45	\$ 3.25	\$ 2.75

Bowls



CODE	10CW	10CWL	35CW	45CW	50CW	60CW	100CW	150CW
APPROX. CAPACITY	9.4 oz.	—	8.4 oz.	5 oz.	15.3 oz.	10.9 oz.	12.5 oz.	16.7 oz.
DESCRIPTION	Square bowl	Lid for 10CW bowl	Bouillon	#3 $\frac{1}{2}$ Fruit cup	Nappie bowl	#1 Grapefruit bowl	5" Nappie	Square bowl
CASE PACK	48	48	48	48	48	48	48	48
SHAPE	Square	Square	Round	Round	Round	Round	Round	Top/Rnd-Bottom/Sqr
OUTSIDE DIA.	Top: 4" x 4"	—	3 $\frac{3}{16}$ "	4 $\frac{5}{8}$ "	5 $\frac{1}{4}$ "	6"	5"	Top: 5 $\frac{1}{4}$ "
HEIGHT	1 $\frac{7}{8}$ "	7 $\frac{7}{8}$ "	2 $\frac{1}{8}$ "	1 $\frac{1}{16}$ "	2 $\frac{1}{8}$ "	1 $\frac{1}{2}$ "	1 $\frac{11}{16}$ "	2 $\frac{3}{8}$ "
LIST PRICE EACH	\$ 3.25	\$ 2.50	\$ 2.25	\$ 2.75	\$ 3.25	\$ 3.25	\$ 2.80	\$ 4.45

Mugs and Cups



CODE	75CW	96CW
APPROX. CAPACITY	7.5 oz.	9.6 oz.
DESCRIPTION	Stacking cup	Mug
CASE PACK	48	48
MAX DIA. / HEIGHT	4 $\frac{1}{16}$ " - 3 $\frac{3}{16}$ "	4 $\frac{1}{16}$ " - 3 $\frac{3}{4}$ "
FULL SIZE CAMRACK®	16C414	16C414
LIST PRICE EACH	\$ 4.25	\$ 4.25

Maximum diameter includes handle.

Camwear® Heat Keepers



CODE	HK93CW	HK39
DESCRIPTION	3 Compartment base and cover	Heat keeper base and cover for 9" plate
CASE PACK	6	6
LIST PRICE EACH	\$ 28.95	\$ 30.50

HK93CW is available in Beige (133). HK39 is available in Antique White (148).

HK93PMC

Camcarrier® for HK93CW available by special request. Call Cambro Customer Service for more information.

VERSA CAMCOVERS®

Serve hot food hot with the Versa Camcover, an elegant and efficient alternative to traditional metal covers.

- Microwave safe plate covers withstands temperatures up to 300°F (149°C)*.
- Covers remain cool to the touch for easy handling.
- Lighter and quieter than metal covers.
- Elegant appearance without polishing.
- Keeps food warm longer than metal covers.

- Available in a variety of sizes in round and square.
- Made of fiberglass material.

Colors: Ivory (380), Granite Gray (191), Antique Parchment (101).

*Can be used in heated carts.

For help selecting the correct size plate cover, refer to the Camcover Sizing Guide on our website at www.cambro.com. Or, send one of your plates to Cambro Customer Service for sizing.

Microwave safe.



CODE	INSIDE DIAMETER	OUTSIDE HEIGHT	LIST PRICE EA.
Square			
85SFVS	8 ⁵ / ₈ "	2 ³ / ₄ "	\$ 13.40
978SFVS	10"	2 ³ / ₄ "	13.65
Round			
68VS	6 ¹ / ₂ "	2 ³ / ₁₆ "	11.35
86VS	8 ¹ / ₄ "	2 ⁵ / ₈ "	12.55
91VS	9 ¹ / ₈ "	2 ¹ / ₁₆ "	13.40
913VS	9 ¹³ / ₁₆ "	2 ¹ / ₁₆ "	13.40
95VS	9 ⁵ / ₁₆ "	2 ¹ / ₁₆ "	13.40
99VS	9 ⁹ / ₁₆ "	2 ⁵ / ₈ "	13.40
911VS	9 ¹¹ / ₁₆ "	2 ³ / ₄ "	13.80
100VS	10"	2 ¹ / ₁₆ "	13.65
103VS	10 ³ / ₁₆ "	2 ¹ / ₁₆ "	14.05
105VS	10 ⁵ / ₁₆ "	2 ¹ / ₁₆ "	14.05
106VS	10 ¹³ / ₃₂ "	2 ³ / ₁₆ "	15.75
1010VS	10 ⁵ / ₈ "	2 ¹ / ₁₆ "	14.90
1012VS	10 ³ / ₄ "	2 ¹ / ₁₆ "	14.90
1014VS	10 ⁷ / ₈ "	2 ¹ / ₁₆ "	14.90
116VS	11 ³ / ₈ "	3 ³ / ₁₆ "	16.05
120VS	12"	2 ⁷ / ₈ "	20.60
124VS	12 ¹ / ₄ "	2 ⁷ / ₈ "	21.35

Case Pack: 12



CAMWEAR® CAMCOVERS

- Food stays hot and appetizing without re-heating.
- Ideal for use in heated carts up to 210°F (99°C)*.
- Made of durable Camwear, will not dent or scratch.
- Lightweight for quiet service.
- Saves on labor with no polishing required.

Colors: Clear (152), Amber (153), Beige (133), Silver (486).

MDCPC9CW Colors: Clear (135), Amber (153), Beige (133), Silver (486).

For help selecting the correct size plate cover, refer to the Camcover Sizing Guide on our website at www.cambro.com. Or, send one of your plates to Cambro Customer Service for sizing.



CODE	INSIDE DIAMETER	OUTSIDE HEIGHT	LIST PRICE EA.
Camwear Camcovers			
806CW	8 ⁷ / ₁₆ "	2 ¹ / ₁₆ "	\$ 9.75
900CW	9 ¹ / ₈ "	2 ³ / ₄ "	9.85
901CW	9 ¹ / ₁₆ "	2 ¹³ / ₁₆ "	10.50
905CW	9 ¹ / ₂ "	2 ¹³ / ₁₆ "	10.80
909CW	9 ³ / ₄ "	2 ³ / ₄ "	10.75
9011CW	10"	2 ⁷ / ₈ "	11.70
9013CW	10"	2 ³ / ₄ "	11.70
1000CW	10 ³ / ₁₆ "	2 ¹ / ₁₆ "	11.65
1005CW	10 ⁵ / ₁₆ "	2 ¹³ / ₁₆ "	11.90
1007CW	10 ⁵ / ₈ "	2 ³ / ₄ "	11.90
1013CW	10 ¹³ / ₁₆ "	2 ¹ / ₁₆ "	11.95
1101CW	11"	2 ¹ / ₁₆ "	11.90
1202CW	12 ¹ / ₂ "	2 ³ / ₄ "	11.95
Camwear Low Profile Camcover			
MDCPC9CW	9 ¹ / ₈ "	2"	8.75

Case Pack: 12

BEVERAGE DISPENSER, PAIL WITH BAIL AND SWIRL BOWLS®



6-Gallon Beverage Dispenser

- Perfect for mixing and serving concentrated beverages.
- Standard and metric graduations are printed on dispenser.
- Impact resistant polyethylene withstands temperatures from -40° to 160°F (-40° to 70°C).

CODE	LIST PRICE EA.
DSPR6	\$ 48.55

Case Pack: 1 **Color:** White (148).
DSPR6 Capacity: 6 gallons (22,7 L).



Pail with Bail – Poly

- A large, multi-purpose, 22 quart (20,8 L) pail, ideal for mixing, storing and transporting.
- Durable polyethylene withstands temperatures from -40° to 160°F (-40° to 70°C), and is stain resistant.
- Snap-tight, thumb tab cover sold separately.

CODE	LIST PRICE EA.
PWB22	\$ 28.40
RFSC12 (cover)	5.30

Case Pack: 6 **Color:** White (148).
 All graduations are approximate.



Swirl Bowls

- Ideal for hot or cold side dishes, desserts, dips, or fruit.
- Fits on a plate or stacks in place on a buffet station.
- Available in durable Camwear® or break resistant SAN.

Colors:
SRB5CW and SRB13CW: Clear (135), Black (110), White (148).
SRB5 and SRB13: Clear (152), Black (110), White (148).

*Made of (P.E.T.) material.



SRB13CW

SRB5CW

CODE	CAPACITY	CASE PACK	LIST PRICE EA.
Camwear			
SRB5CW	5 oz.	24	\$ 2.25
SRB13CW	13	24	4.45
SAN			
SRB5	5	24	1.95
SRB13	13	24	3.65
Disposable Lid			
CLSRB5*	Fits 5 oz. only	1,000	146.45

Disposable Lid Color: Clear (152). **InStock Colors:** Clear (152).

CAMWEAR® WINE BUCKETS, PUNCH BOWLS AND BUD VASE

Wine Buckets

- Chill and showcase wine or champagne.
- Tough Camwear won't crack or break and is easy to clean.

Color: Clear (135).



WC100CW

CODE	SIZE DIA. x H	LIST PRICE EA.
WC100CW	8" x 9½"	\$ 43.45
WC100CWNH (without handles)	8" x 9"	25.00

Case Pack: 1

Pebbled Pedestal Punch Bowls

- Perfect for parties, weddings and receptions.
- Made of durable Camwear.
- Attractive pebbled exterior is scratch resistant and smooth interior is easy to clean.

Color: Pebbled (176).

Capacities are calculated to rim.



CODE	INSIDE DIAMETER	APPROX. CAPACITY	LIST PRICE EA.
PPB15	15"	11.2 qt.	\$ 76.65
PPB18	18"	20.2	101.10
PPB23	23"	40	173.90

Case Pack: 1

Bud Vase

- Ideal for dining rooms, cafeteria tables and patient or room service trays.
- Made of durable Camwear.
- Fill with a fresh rose bud or a colorful faux flower.

Colors: Black (110), Clear (135), White (148).



CODE	DESCRIPTION	LIST PRICE EA.
BV6CW	6" Bud vase	\$ 3.50

Case Pack: 12

PROMOTE YOUR BRAND – PERSONALIZED TABLE SERVICE AND FOOD STORAGE PRODUCTS

Personalize tumblers, barware, pitchers, decanters and dinnerware to promote a brand, business or enhance customer satisfaction. Use to identify inventory for multiple service locations. Personalize food storage products to identify contents, add fill lines with recipe instructions to ensure product quality and consistency. Personalized product orders are full case quantities only, no broken cartons.



Look for this icon that identifies items that can be personalized.

PAD PRINT PERSONALIZATION

- One color. Two color available for table service products only.
- Choose from 12 standard imprint colors.
- Print area is 1/4" – 4", based on printable area specific to product. Order minimum 72 each.

PERSONALIZATION CHARGES

- Custom Personalization Plate Charge.
- \$75.00 Net (one-time charge, billed on first purchase order).
- Set Up Charge \$50.00 Net per order.
- Color Imprint Charge \$.30 Net per side, per color.

HOW TO ORDER A SAMPLE

1. Request a Sample
Contact your local Cambro representative to complete and submit your sample request to Cambro. Form **MUST BE** submitted with artwork.

2. Artwork
Must be ready to use, digital format only. Email to Cambro Representative or to Cambro at letsgetpersonal@Cambro.com. Title email subject with logo name. Provide contact info. If artwork is incomplete, graphic services are available for \$50.00 per hour.
File Dimensions: 100% reproduction size, 300 dpi resolution
File Type: Adobe® Illustrator®, Photoshop®
File Format: jpeg, tiff, eps.

3. Sample Turnaround
7 – 10 business days from approval of artwork.

4. Sample Approval
Signed approval form must be included with purchase order for processing. This form is included with each sample.

5. Sample Charge (net)
\$50.00 per sample (charge billed on sample order, credited back on first purchase order).

6. Questions
Contact Kristie Patterson at 714-230-4125 direct, 800-854-7631 Ext. 4125 or email kpatterson@Cambro.com.



CHOOSE ONE OR TWO STANDARD IMPRINT COLORS



Due to the catalog printing process, the colors shown may not be exact.

DISPLAY



DELI CROCKS & PLATTER

- Prep, store and serve all in one with contemporary style at an economical price.
- Crock and platter are made of SAN, making them impact, stain and chip resistant.
- Ideal for supermarket delis, sandwich shops, buffets and catered events.
- Handled covers are made of crystal clear, virtually unbreakable Camwear®.

Crock and Platter Colors: Clear (152), Black (110), White (148), Red (404).

Crock Cover Color: Clear (135).

Deli Crock covers are covered by the following U.S. Patents D 504,283 S, D 503,871 S & D 494,419 S. Scalloped Food Service Cover is covered by the following U.S. Patent D 509,705 S.

DCC5, DCC10 are NSF Component.



Prep, stack, store and serve all in one.



Interstacking saves storage space.



Avoid cross contamination and keep food fresh by using clear cover with handle.



Lid can be used as a riser to provide additional height on the buffet table or in a deli display case.



Cover doubles as a false bottom for presentation and to reduce waste.

Crocks & Platter



CODE	DC5	DC10	DP15
DESCRIPTION	Crock	Crock	Platter
DIMENSIONS L x D x H	10 ⁵ / ₁₆ " x 6 ¹³ / ₁₆ " x 3 ³ / ₁₆ "	13 ³ / ₁₆ " x 10 ⁷ / ₁₆ " x 3 ³ / ₁₆ "	15 ³ / ₄ " x 11 ⁵ / ₁₆ " x 2 ³ / ₁₆ "
APPROX. CAPACITY	2.2 qt.	4.9 qt.	3.4 qt.
LIST PRICE EACH	\$ 11.70	\$ 16.05	\$ 13.75

Case Pack: 6

Covers



CODE	DCC5 fits DC5	DCC10 fits DC10
DIMENSIONS L x D x H	9 ³ / ₈ " x 5 ⁷ / ₈ " x 1 ¹ / ₁₆ "	12 ³ / ₁₆ " x 9 ⁷ / ₁₆ " x 1 ¹ / ₁₆ "
APPROX. CAPACITY	0.9 qt.	2 qt.
LIST PRICE EACH	\$ 8.20	\$ 11.45

Case Pack: 6



SHOWFEST® DISPLAY BOWLS & TRAYS

- Showcase cold deli, buffet and salad bar items.
- Made from SAN for impact, stain, break & chip resistance.
- Variety of shapes and sizes to make the best use of display area.

Color: Black (110).



Scalloped Ovals



CODE	SFV1015
DIMENSIONS L x D x H	15" x 10" x 2½"
APPROX. CAPACITY	3 qt.
LIST PRICE EACH	\$ 18.85

Case Pack: 6

Scalloped Rectangles



CODE	SFR1012
DIMENSIONS L x D x H	12½" x 10" x 3"
APPROX. CAPACITY	4.5 qt.
LIST PRICE EACH	\$ 18.15

Case Pack: 6



Octagonals



CODE	SFG1012	SFG1015	SFG820	SFG1220
DIMENSIONS L x D x H	12" x 10" x 2"	15" x 10" x 2"	20" x 8" x 2"	20" x 12" x 2"
APPROX. CAPACITY	3 qt.	3.5 qt.	4 qt.	6 qt.
LIST PRICE EACH	\$ 18.15	\$ 19.30	\$ 20.55	\$ 24.65

Case Pack: 6

CAMWEAR® BOWLS

Round Pebbled Bowls

- Textured on the outside for an elegant look, smooth on the inside for easy cleaning.
- Made of virtually unbreakable Camwear for years of dependable service.
- Ideal for fruit, salads, snacks and desserts.

Color: Pebbled (176).

 Capacities are calculated to rim.



Ribbed Bowls

- Stylish, contemporary appearance for a dramatic presentation.
- Made of virtually unbreakable Camwear that won't break like glass.
- Bowls are durable and lightweight. Will not chip and crack like acrylic.
- Resistant to stains, acids and odors.

Colors: Clear (135), Black (110), White (148).

 Rectangular Ribbed Bowls are not available in White (148).

 Capacities are calculated to rim.



Round Pebbled Bowls



CODE	PSB6	PSB8	PSB10	PSB12
INSIDE DIAMETER	6"	8"	10"	12"
OUTSIDE DIAMETER x HEIGHT	6 ¹³ / ₁₆ " x 1 ¹ / ₂ "	8 ¹³ / ₁₆ " x 2 ¹ / ₁₆ "	10 ¹³ / ₁₆ " x 3 ³ / ₄ "	12 ¹³ / ₁₆ " x 4"
APPROX. CAPACITY	18.8 oz.	1.6 qt.	3.2 qt.	5.8 qt.
CASE PACK	12	12	12	12
LIST PRICE EACH	\$ 3.65	\$ 6.25	\$ 12.30	\$ 15.90

InStock Color: Pebbled (176).

CAMWEAR® BOWLS

Round Pebbled Bowls



CODE	PSB15	PSB18	PSB23
INSIDE DIAMETER	15"	18"	23"
OUTSIDE DIAMETER x HEIGHT	15 ³ / ₄ " x 4 ⁷ / ₈ "	18 ³ / ₄ " x 5 ³ / ₄ "	23 ³ / ₄ " x 7 ¹ / ₁₆ "
APPROX. CAPACITY	11.2 qt.	20.2 qt.	40 qt.
CASE PACK	4	4	4
LIST PRICE EACH	\$ 25.90	\$ 41.25	\$ 62.85

InStock Color: Pebbled (176).

Rectangular Ribbed Bowls



CODE	RSB912CW	RSB1014CW	RSB1419CW
DIMENSIONS L x D x H	12 ¹ / ₈ " x 9" x 3"	14 ⁹ / ₁₆ " x 10 ¹³ / ₁₆ " x 3 ⁹ / ₁₆ "	19 ³ / ₁₈ " x 14 ³ / ₁₈ " x 4 ¹¹ / ₁₆ "
APPROX. CAPACITY	2.9 qt.	5 qt.	12 qt.
CASE PACK	12	4	4
LIST PRICE EACH	\$ 12.65	\$ 18.50	\$ 30.00

Rectangular Ribbed Bowls are not available in White (148).

Round Ribbed Bowls



CODE	RSB6CW	RSB8CW	RSB10CW	RSB12CW
INSIDE DIAMETER	6"	8"	10"	12"
OUTSIDE DIAMETER x HEIGHT	6 ¹ / ₁₆ " x 1 ¹ / ₂ "	8 ³ / ₁₆ " x 2 ¹ / ₁₆ "	10 ¹³ / ₁₆ " x 3 ¹ / ₄ "	12 ¹³ / ₁₆ " x 4"
APPROX. CAPACITY	18.8 oz.	1.65 qt.	3.2 qt.	5.8 qt.
CASE PACK	12	12	12	12
LIST PRICE EACH	\$ 4.55	\$ 8.85	\$ 16.20	\$ 27.00



CODE	RSB15CW	RSB18CW	RSB23CW
INSIDE DIAMETER	15"	18"	22 ⁷ / ₈ "
OUTSIDE DIAMETER x HEIGHT	15 ³ / ₄ " x 4 ¹⁵ / ₁₆ "	18 ³ / ₄ " x 5 ¹³ / ₁₆ "	23 ³ / ₄ " x 7 ¹ / ₁₆ "
APPROX. CAPACITY	11.2 qt.	20.2 qt.	40 qt.
CASE PACK	4	4	4
LIST PRICE EACH	\$ 34.90	\$ 50.25	\$ 75.70

InStock Color: Black (110).

BELL-SHAPED, BUDGET & FIBERGLASS BOWLS

Camwear® Bell-Shaped Pebbled Bowls

- Perfect for showcasing fruits and salads.
- A versatile alternative to Cambro traditional Round Pebbled Bowls.
- Made from virtually unbreakable Camwear.

Color: Pebbled (176).

Capacities are calculated to rim.



CODE	BSB10	BSB12	BSB18
INSIDE DIAMETER	9 ¹ / ₈ "	12"	18"
OUTSIDE DIAMETER x HEIGHT	10 ³ / ₄ " x 3 ³ / ₈ "	12 ³ / ₄ " x 4 ¹ / ₁₆ "	18 ³ / ₄ " x 5 ¹ / ₂ "
APPROX. CAPACITY	2.1 qt.	4 qt.	12.5 qt.
CASE PACK	12	4	4
LIST PRICE EACH	\$ 12.30	\$ 15.85	\$ 33.40

Budget Salad Bowls

- An economical serving choice for fruit, salads, snacks and desserts.
- Impact resistant FDA approved material resists stains, acids and odors.

Colors: Birch (174), Black (110).

Capacities are calculated to rim.



CODE	SB55	SB60	SB80
INSIDE DIAMETER	5 ¹ / ₁₆ "	6"	8"
OUTSIDE DIAMETER x HEIGHT	5 ¹ / ₁₆ " x 1 ¹ / ₁₆ "	6" x 1 ¹ / ₁₆ "	8" x 2 ¹ / ₁₆ "
APPROX. CAPACITY	10.9 oz.	12.6 oz.	31.2 oz.
LIST PRICE EACH	\$ 1.95	\$ 2.35	\$ 4.80

Case Pack: 72



Fiberglass Bowls

- Combines the look of warm wood grains with the durability of fiberglass.
- Colors won't fade even after years of service and washing.

Color: Dark Basketweave (301).

Capacities are calculated to rim.



CODE	6F	8F
INSIDE DIAMETER	6 ¹ / ₈ "	8"
OUTSIDE DIAMETER x HEIGHT	6 ¹ / ₈ " x 1 ¹ / ₂ "	8" x 2"
APPROX. CAPACITY	14.3 oz.	31.2 oz.
LIST PRICE EACH	\$ 12.25	\$ 14.25

Case Pack: 12



CROCKS AND LADLES

Crocks

- Resists stains and odors caused by vinegar, salad oils, or mayonnaise.
- Made of high impact FDA accepted material.
- Smooth surface is easy-to-clean.
- Works in Salad Bar Holder SBH15 and Crock Holder CPH3.

Solid Color Crock Colors:
Black (110), Beige (133),
Reddish Brown (195), White (148).
Lid Color: White (148).
Clear Crock Color: Clear (152).

*Lids for Solid Color and Clear Crocks are not interchangeable.



CODE	CAPACITY	CASE PACK	LIST PRICE EA.
Solid Color Crocks			
CP12	1.2 quart w/lid	12	\$ 8.85
CP15	1.5 quart w/lid	6	10.95
CP27	2.7 quart w/lid	6	12.50
Lids for Solid Color Crocks			
CPL12*	Fits CP12 crock	12	1.50
CPL27*	Fits CP15 & CP27 crock	12	1.55
Clear Crocks			
CCP12	1.2 quart w/lid	12	10.15
CCP15	1.5 quart w/lid	6	15.85
CCP27	2.7 quart w/lid	6	16.90
Lids for Clear Crocks			
CCPL12*	Fits CCP12 crock	12	1.45
CCPL27*	Fits CCP15 & CCP27 crock	12	1.50

CODE	HEIGHT	TOP DIAMETER	CUT OUT DIAMETER
Solid Color Crock with Lid			
CP12	5 $\frac{5}{16}$ "	5 $\frac{1}{16}$ "	4 $\frac{3}{4}$ "
CP15	4 $\frac{5}{16}$ "	6 $\frac{5}{8}$ "	6 $\frac{3}{16}$ "
CP27	6 $\frac{3}{4}$ "	6 $\frac{5}{8}$ "	6 $\frac{1}{8}$ "
Clear Color Crock with Lid			
CCP12	5 $\frac{3}{4}$ "	5 $\frac{1}{4}$ "	4 $\frac{7}{8}$ "
CCP15	4 $\frac{3}{8}$ "	6 $\frac{3}{4}$ "	6 $\frac{1}{4}$ "
CCP27	6 $\frac{3}{4}$ "	6 $\frac{3}{4}$ "	6 $\frac{3}{16}$ "

InStock Color: Black (110).

Camwear® Ladles

- Portion control bowls serve the perfect amount of dressing or food ingredient.
- Angled for easy handling.
- Designed with a side rest so ladles don't slip into crocks or serving bowls.
- Made of virtually unbreakable Camwear for years of dependable service.

Colors: Black (110), Beige (133), Clear (135), White (148).

*Cambro's assortment pack is available in black only. It offers 8 imprinted ladles and 4 with no imprinting. The 8 imprints include: 1 Thousand Island, 1 French, 1 House, 1 Italian, 1 Bleu Cheese, 1 Ranch, 1 Low Cal, 1 Caesar. This makes a perfect start-up set for a salad bar.

Custom Order Ladle Imprints – See personalization section for information, ordering and pricing. Maximum imprint area is 1" x 1/2". Six dozen minimum.

No broken cartons on assortment pack or imprinted ladles. Special order item not carried in stock, non-returnable.



Imprinted Ladles shown.

CODE	DESCRIPTION	LENGTH	CAPACITY	LIST PRICE EA.
LD85	Plain	8 $\frac{1}{2}$ "	$\frac{3}{4}$ oz.	\$ 3.40
LD85A*	Assortment	8 $\frac{1}{2}$ "	$\frac{3}{4}$	4.90
LD105	Plain	10 $\frac{1}{16}$ "	1	3.40
LD105A*	Assortment	10 $\frac{1}{16}$ "	1	4.90
LD130	Plain	13"	1	3.80

Case Pack: 12 InStock Color: Black (110).

SERVING SPOONS, CAMTENSILS® & TURNERS

Camwear® Serving Spoons

- Made of virtually unbreakable Camwear, spoons won't tarnish, bend or dent.
- A wide handle and molded in thumb rest ensure a solid, ergonomic grip.
- Spoons feature a notched back to rest on pans.
- Spoon capacities are approximate and are not intended for measuring.

Colors: Black (110), Beige (133), Clear (135), White (148) Red (404).

InStock Color: Black (110).

*Cannot be personalized.



Perforated



SPOP10CW
DESCRIPTION: ¾ oz. 10"
Perforated salad spoon
DIMENSIONS: 10¼" x 1⅛"
LIST PRICE EACH: \$ 2.85
Case Pack: 12



SPOP11CW*
DESCRIPTION: 11"
Perforated deli spoon
DIMENSIONS: 11⅞" x 2⅞"
LIST PRICE EACH: \$ 3.50
Case Pack: 12



SPOP13CW*
DESCRIPTION: 13"
Perforated deli spoon
DIMENSIONS: 13⅞" x 2⅞"
LIST PRICE EACH: \$ 6.00
Case Pack: 12

See personalization section for information, ordering and pricing.

Solid



SPO8CW
DESCRIPTION: ½ oz. 8"
Salad spoon
DIMENSIONS: 8⅞" x 1½"
LIST PRICE EACH: \$ 2.60
Case Pack: 12



SPO10CW
DESCRIPTION: ¾ oz. 10"
Buffet spoon
DIMENSIONS: 10¼" x 1⅛"
LIST PRICE EACH: \$ 2.85
Case Pack: 12



SPO11CW*
DESCRIPTION: 11"
Deli spoon
DIMENSIONS: 11⅞" x 2⅞"
LIST PRICE EACH: \$ 3.50
Case Pack: 12



SP013CW*
DESCRIPTION: 13"
Deli spoon
DIMENSIONS: 13⅞" x 2⅞"
LIST PRICE EACH: \$ 6.00
Case Pack: 12

High Heat Camtensils, Spoons and Turners

- Ideal for preparing and serving hot and cold foods.
- Made of a durable high heat material that withstands temperatures from -40° to 375°F (-40° to 190°C).
- Handle includes a hole for hanging when not in use and notches to rest on pans.

Colors: Amber (150), Black (110).

InStock Color: Black (110).



SP013
DESCRIPTION: 13"
Solid spoon
DIMENSIONS: 13⅞" x 2⅞"
LIST PRICE EACH: \$ 11.25
Case Pack: 12



SPA14
DESCRIPTION: 14"
Solid turner
DIMENSIONS: 14⅞" x 3½"
LIST PRICE EACH: \$ 12.60
Case Pack: 12



SPOP13 PERFORATED
DESCRIPTION: 13"
Perforated spoon
DIMENSIONS: 13⅞" x 2⅞"
LIST PRICE EACH: \$ 11.25
Case Pack: 12



SPASL14 SLOTTED
DESCRIPTION: 14"
Slotted turner
DIMENSIONS: 14⅞" x 3½"
LIST PRICE EACH: \$ 12.60
Case Pack: 12



LUGANO® TONGS

Lugano Flat and Scallop Grip Tongs

- Flat Tongs are ribbed to provide a secure hold.
- Scallop Tongs feature an ergonomic design and secure finger grip.

FLAT GRIP



TG6
LENGTH: 6"
LIST PRICE EACH: \$ 2.50
Case Pack: 12



TG9
LENGTH: 9"
LIST PRICE EACH: \$ 4.00
Case Pack: 12

SCALLOP GRIP



6TGS
LENGTH: 6"
LIST PRICE EACH: \$ 2.60
Case Pack: 12



9TGS
LENGTH: 9"
LIST PRICE EACH: \$ 4.00
Case Pack: 12

Colors: Black (110), Beige (133), Clear (135), Red (404), White (148).

InStock Color: Black (110).



12TGS
LENGTH: 12"
LIST PRICE EACH: \$ 6.10
Case Pack: 12



Lugano Angled and Easy-Grasp Tongs

- Angled tongs feature an ergonomic design that makes it easy to serve a variety of foods.
- Easy-Grasp Tongs provide a secure grip for hard to hold items.

Angled Tong Color: Black (110).
Easy-Grasp Tong Colors: Black (110), Beige (133), Clear (135), White (148).

InStock Color: Black (110).



ANGLED TONG



TGA8
LENGTH: 8 1/4"
LIST PRICE EACH: \$ 3.95
Case Pack: 12



TGA11
LENGTH: 10 13/16"
LIST PRICE EACH: \$ 4.65
Case Pack: 12

EASY-GRASP



TGG6
LENGTH: 6 9/16"
LIST PRICE EACH: \$ 3.95
Case Pack: 12



TGG9
LENGTH: 9 1/2"
LIST PRICE EACH: \$ 4.25
Case Pack: 12



CAMVIEW® SHAKERS/DREDGES & CAMWEAR® CONDIMENT JARS

CamView Shakers/Dredges

- A staple in the kitchen, at the condiment station or on the dining table.
- Clear shatter-resistant CamView and color coded lids make it easy to identify contents.
- Dishwasher safe and unaffected by food acids.

Shaker Color: Clear (135).



96SKRLD
Salt & Pepper



96SKRLM
Med. Ground



96SKRLC
Cheese



96SKRLP
Parsley

CODE	COLOR	APPROX. CAPACITY	LIST PRICE EA.
Shakers Complete with Lids			
96SKRP (w/parsley lid)	—	10	\$ 5.85
96SKRD (w/salt & pepper lid)	—	10	5.85
96SKRC (w/cheese lid)	—	10	5.85
96SKRM (w/medium ground lid)	—	10	5.85

Case Pack: 12 InStock Color: Clear (135).

Lids

96SKRLP parsley lid	White (148)	—	1.00
96SKRLD salt & pepper lid	Beige (406)	—	1.05
96SKRLC cheese lid	Yellow (405)	—	1.05
96SKRLM medium ground lid	Rose (408)	—	1.05

Case Pack: 12

Camwear Condiment Jars

- Use to hold condiments such as mustard, ketchup, dressings, jam or salsa.
- Made of clear, virtually unbreakable Camwear.
- Lids are slotted to hold serving spoons when not in use.

Color: Clear (135).



CODE	APPROX. CAPACITY	SIZE H x DIA.	CASE PACK	LIST PRICE EA.
Jar & Cover				
CJ80CW*	8 oz.	4" x 3 3/4"	24	\$ 8.25

*Spoons not included.

CAMWEAR® DISPLAY COVERS & TRAYS

- Display covers protect freshness of pastries, breads and desserts.
- Virtually unbreakable Camwear features the upscale look of glass.
- Openings on side or end provide quick and easy access to contents without removing cover.

Display Covers Color: Clear (135).

Display Tray Colors:
Clear (135), Black (110).



Display Trays are stackable.
Display Trays cannot be personalized.
Refer to Market Tray page for information.



RD1200CW



RD1220CW



RD1220CWH



*DD1220BECW



DD1220SCW



Display Tray – DT1220CW

CODE	DESCRIPTION	APPROX. DIMENSIONS W x D x H*	CASE PACK	LIST PRICE EA.
Display Covers				
RD1200CW	Cake cover	12" x 12" x 8¼"	1	\$ 29.95
DD1220CW	Dome cover	21⅞" x 14¾" x 8"	1	51.75
DD1220ECW	Dome w/end cut	21⅞" x 14¾" x 8"	1	65.40
DD1220BECW	Dome w/2 ends cut	21⅞" x 14¾" x 8"	1	79.65
DD1220SCW	Dome w/side cut	21⅞" x 14¾" x 8"	1	65.40
DD1826CW	Dome cover	26¾" x 18⅞" x 8⅞"	1	72.60
RD926CW	Rectangular cover	26⅝" x 10" x 6¼"	1	48.20
RD1220CW	Rectangular cover	21⅞" x 14⅞" x 5⅞"	1	54.75
RD1220CWH	Rectangular w/hinge	21⅞" x 14⅞" x 5"	1	77.90
RD1826CW	Rectangular cover	26⅝" x 18⅞" x 6¼"	1	70.95
RD1826CWH	Rectangular w/hinge	26¾" x 18¾" x 5⅞"	1	82.80
Display Tray – Fits with all 1220 Covers				
DT1220CW	Tray	12" x 20"	1	20.85
Market Tray – Fits with all 1826 Covers				
1826MT	Tray	25 ¹³ / ₁₆ " x 17 ¹³ / ₁₆ " x 1 ¹ / ₁₆ "	6	34.25

*Dimensions include handle(s). Handle height is 13/16".

TRAYS



TRAYS AT A GLANCE

Patron Trays

Camtray®

The industry standard. Durable fiberglass construction.



43 SIZES	8 SHAPES	53 COLORS
-------------	-------------	--------------



PRORATED

Non-Slip Service Trays

Camtread® Trays

Durable fiberglass construction with non-skid surface. Grips service items to avoid spills.



16 SIZES	3 SHAPES	2 COLORS
-------------	-------------	-------------



PRORATED

Camlite® Tray

Combine economy with durability. Fiberglass construction.



6 SIZES	1 SHAPE	9 COLORS
------------	------------	-------------



PRORATED

Treadlite™ Tray

Fiberglass reinforced polyester lightweight tray with molded in non-skid surface ensures items stay in place during service.



2 SIZES	1 SHAPE	2 COLORS
------------	------------	-------------



PRORATED

Camwear® Trays

Made of durable Camwear.



3 SIZES	3 SHAPES	5 COLORS
------------	-------------	-------------



PRORATED

Polytread® Trays

General purpose tray with non-skid surface.



6 SIZES	2 SHAPES	2 COLORS
------------	-------------	-------------



PRORATED

Fast Food Tray

Economical choice that withstands frequent use.



3 SIZES	1 SHAPE	14 COLORS
------------	------------	--------------



PRORATED

Décor Series Camtrays

Woodgrain textured surface with durability of the classic Camtray. Also available in clear EpicTread non-slip surface.



3 SIZES	1 SHAPE	5 COLORS
------------	------------	-------------



PRORATED

Healthcare Dietary Tray

Low profile offers patient comfort. Made of durable fiberglass. Camtray and Non-Skid Versa Camtrays are also recommended for patient meal delivery.



6 SIZES	1 SHAPE	53 COLORS
------------	------------	--------------



PRORATED

Camwear Non-Skid Tray

Made of durable Camwear. Non-skid surface grips items firmly.



2 SIZES	2 SHAPE	3 COLORS
------------	------------	-------------



PRORATED

TRAYS AT A GLANCE

Non-Skid Versa Camtrays®

Non-Skid Versa Trays reduce waste, save money and provide a stable tray surface for meal delivery.



2 SIZES	3 SHAPES	3 COLORS
------------	-------------	-------------



Compartment Serving Trays

Compartment configurations to meet all menu requirements. Warranty varies by material.



3 SIZES	3 SHAPES	7 COLORS
------------	-------------	-------------



Service Trays

Hotel Room Service Tray

Lightweight yet durable service tray features a contemporary design.



1 SIZE	1 SHAPE	3 COLORS
-----------	------------	-------------



Trapezoid Compartment Tray

Offers seven deep compartments for ample, portion controlled serving.



1 SIZE	1 SHAPE	1 COLOR
-----------	------------	------------



Display Trays

Market Trays and Pans

Ideal for merchandising food items in showcases. Durable fiberglass construction.

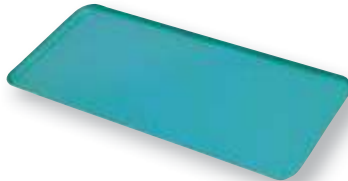

19 SIZES	1 SHAPE	5 COLORS
-------------	------------	-------------



Separator® Compartment Trays

Tray with cover separates each compartment to retain food temperature and reduce spills. Warranty varies by material.



2 SIZES	1 SHAPE	4 COLORS
------------	------------	-------------



Compartment Trays

Compartment Tray

Six compartment tray available in three materials. Warranty varies by material.



1 SIZE	1 SHAPE	10 COLORS
-----------	------------	--------------



Tray on Tray Meal Delivery System

Use Insert Tray and Base Tray to serve hot and cold foods together. Warranty varies by material.



3 SIZES	2 SHAPES	4 COLORS
------------	-------------	-------------



2 x 2 Compartment Trays

Durable trays with easy grip handles. Trays fit side by side in dishrack to reduce warewashing expense. Warranty varies by material.



2 SIZES	2 SHAPES	9 COLORS
------------	-------------	-------------



Meal Delivery Trays

Deep compartments and snap-on cover. Warranty varies by material.

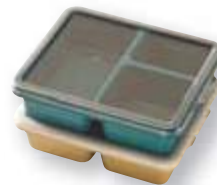

2 SIZES	2 SHAPES	4 COLORS
------------	-------------	-------------



PROMOTE YOUR BRAND – PERSONALIZED CAMTRAY®

Personalize Camtrays to display a message with every tray served. Advertise a product or a brand, promote your business, enhance patient satisfaction or strengthen school spirit. All personalized tray orders are full case quantities only, no broken cartons.

Personalization Charges:

QUANTITY EACH	NET CHARGE PER TRAY
144-299	\$ 0.50
300 and up	Free



Look for this icon that identifies items that can be personalized.

Digital Printing - Edge to Edge:

- Multiple color artwork.
- Print area covers 100% of surface, edge to edge on top and bottom of the tray.
- Order minimum 144 each.
- Available for Decor Series Camtrays and select Camtrays.



Digital Printing - Inside Trays:

- Multiple color artwork as well as photo reproduction.
- Processing requires light colors trays only.
- Printable area up to 1" from the internal tray edge.
- Order minimum 144 each.



Silkscreen Printing Personalization:

- Up to four colors.
- Best for light color artwork on dark color trays.
- Order minimum 144 each.

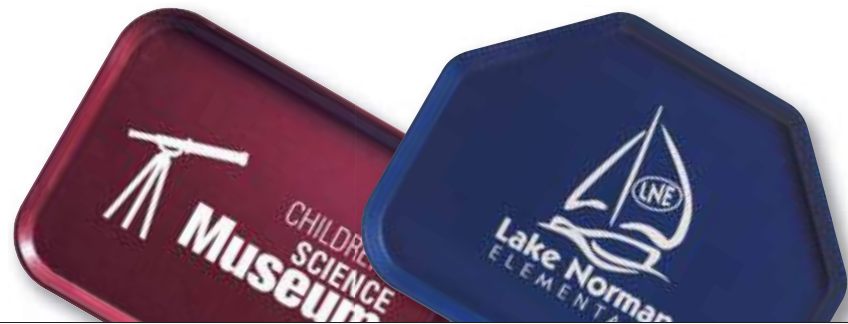

HOW TO ORDER A SAMPLE

1. Request a Sample

Contact your local Cambro Representative to complete and submit sample request form to Cambro. Form **MUST BE** submitted along with artwork.

2. Provide Artwork

Must be ready to use, digital format only. Email to Cambro

Representative or to Cambro at letsgetpersonal@Cambro.com. Title email subject with logo name. Provide contact info. If artwork is incomplete, graphic services are available for \$50.00 per hour.

File Dimensions:

100% reproduction size, 300 dpi resolution.

File Type:

Adobe® Illustrator®, Photoshop®.

File Format: jpeg, tiff, and eps.

3. Sample Turnaround

7 - 10 business days from approval of artwork.

4. Sample Approval

Approval form included with each sample. Form must be completed and be included with the purchase order for order processing.

5. Sample Charge (NET)

\$50.00 per sample (charge billed on sample order, credited back on first purchase order).

6. Questions?

Contact Kristie Patterson at 714-230-4125 direct, 800-854-7631 Ext. 4125 or email kpatterson@Cambro.com.

CAMTRAY®

- Use in restaurants, hotel room service, cafeterias, food courts, hospitals and schools.
- Durable construction backed by five year prorated warranty against manufacturer's defects.
- Made of lightweight, high-impact fiberglass.

- Stain and odor resistant.
- Stacking lugs keep trays stacked securely in place and ensure proper air flow.



Rectangular Camtrays

The industry standard.

Available in Group I colors and patterns and Group III Wood.

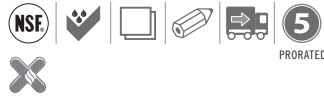

Trapezoid Camtrays

Saves tabletop space and increases seating capacity.

Available in Group I colors and patterns and Group III Wood.

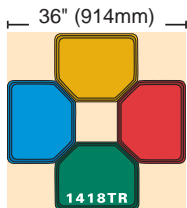
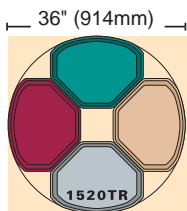
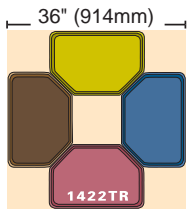

CODE	DIMENSIONS	CASE PACK	LIST PRICE EA.	
			GROUP I	GROUP III
Rectangular				
46	4¼" x 6"	12	\$ 5.10	\$ 7.10
57*	4 ¹⁵ / ₁₆ " x 6 ¹⁵ / ₁₆ "	12	5.50	7.70
810	8" x 9 ⁷ / ₈ "	12	12.15	15.70
915	8¾" x 15"	12	17.25	20.00
926*	8 ⁷ / ₈ " x 25 ⁹ / ₁₆ " x 1"	12	22.55	29.20
1014	10 ⁵ / ₈ " x 13¾"	12	16.00	20.70
1216	12" x 16 ⁵ / ₁₆ "	12	18.50	24.25
1318*	12 ⁵ / ₈ " x 17 ³ / ₄ " x 1 ¹ / ₁₆ "	12	22.95	28.65
1418	14" x 18"	12	22.10	28.80
1520	15" x 20¼"	12	26.70	34.65
1622	16" x 22"	12	30.75	40.00
16225*	16½" x 22½"	12	33.70	42.10
1826	17 ⁷ / ₈ " x 25¾"	6	41.00	52.75
2025*	20¾" x 25 ⁹ / ₁₆ "	6	50.00	60.85
Trapezoid				
1418TR	14" x 18"	12	20.95	28.30
1422TR*	14" x 22"	12	22.95	31.05
1520TR*	14 ⁹ / ₁₆ " x 19½"	12	24.45	31.95

InStock Colors: Antique Parchment (101), Black (110). *Special order item not carried in stock, non-returnable. One case order minimum.

CAMTRAY®

Oval Camtrays

Perfect for banquet service.

Available in Group I colors and patterns (except Doily patterns) and Group III Wood.

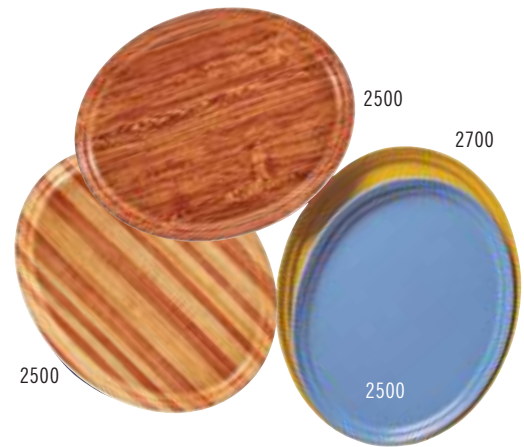

Round Camtrays

A favorite for pizza and beverage service.

Available in Group I colors and patterns (except Doily patterns) and Group III Wood.

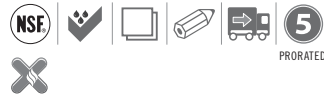

Insert Camtrays

Fits onto a Camtray to separate hot and cold food, ideal for dietary tray service.

Available in Group I colors and patterns (except Doily patterns) and Group III Wood.

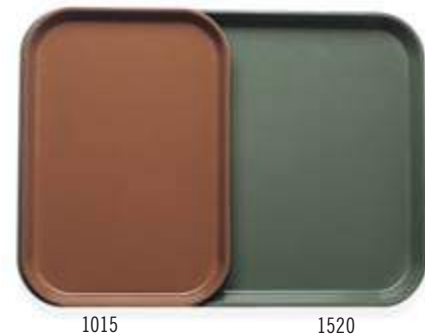

CODE	DIMENSIONS	CASE PACK	LIST PRICE EA.	
			GROUP I	GROUP III
Oval				
2500*	19¼" x 24"	6	\$ 39.95	\$ 52.75
2700*	22" x 26⅞"	6	46.55	61.65
Round				
900*	9"	12	12.30	15.60
1000*	10"	12	13.60	17.65
1100	11"	12	13.60	17.20
1200*	12"	12	15.00	20.10
1300*	13"	12	16.55	21.85
1400	14"	12	16.85	22.85
1550*	16" low profile	12	21.55	28.10
1600	16"	12	21.15	28.30
1950*	19½" low profile	12	29.20	38.50
Insert				
1015* 2 trays fit into a 1520	10⅞" x 15"	24	16.55	21.40
1116* 2 trays fit into a 1622	10⅞" x 15⅞"	24	17.30	24.25

*Special order item not carried in stock, non-returnable.

CAMTRAYS® WITH HANDLES, DIETARY TRAYS AND METRIC CAMTRAY

Camtrays with Handles

- Enhance your tray presentation and improve your customer's experience with these easy-to-grip, ergonomic, contoured handles.
- Made of durable, lightweight and high-impact fiberglass.
- Stacking lugs keep trays stacked securely in place and ensure proper air flow.
- Dishwasher safe at high and low temperatures.

Available in Group I colors.
 Special order item not carried in stock, non-returnable. One case order minimum.
 NSF listed for non-direct food contact only.
 Personalization through digital printing process only. Please refer to Camtray Personalization section for details.
 Camtrays with handles is covered by U.S. Patent D 683,191 S.

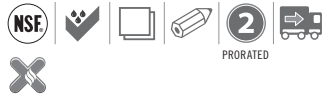

CODE	DIMENSIONS	LIST PRICE EA.
1418H	14" x 18"	\$ 25.00
1520H	15" x 20"	29.75

Case Pack: 12

Healthcare Dietary Trays

- Designed specifically for in-room patient feeding.
- Low slope edge provides easy access when dining from a hospital bed.
- Made of lightweight fiberglass.

Available in Group I colors and patterns and Group III Wood.
 NSF listed for non-direct food contact only.
 Personalization through digital printing process only. Please refer to Camtray Personalization section for details.
 Camtrays with handles is covered by U.S. Patent D 683,191 S.



CODE	DIMENSIONS	CASE PACK	LIST PRICE EA.	
			GROUP I	GROUP III
Dietary				
1216D*	12" x 16"	12	\$ 19.10	\$ 25.35
1219D*	12" x 19"	12	22.45	29.00
1220D*	12" x 20"	12	24.30	31.20
1222D*	12" x 22"	12	24.30	31.15
1418D*	14" x 18"	12	22.25	29.40
1520D*	15" x 20 ³ / ₁₆ "	12	26.45	33.45

*Special order item not carried in stock, non-returnable.

Metric Camtrays

Designed to meet international specifications.

Available in Group I colors and patterns and Group III Wood. 3555TR is available in Group I colors and patterns except Doily.



CODE	DIMENSIONS	CASE PACK	LIST PRICE EA.	
			GROUP I	GROUP III
Metric				
1313*	13" x 13" (33 x 33 cm)	12	\$ 16.55	\$ 21.70

*Special order item not carried in stock, non-returnable.



1313

Other sizes available on www.cambro.com.

CAMTRAY® GROUP I COLORS

Colors listed alphabetically. See numerical reference on following page.



123
Amazon Blue



101
Antique Parchment



513
Bay Leaf Brown



110
Black



409
Blush



116
Brazil Brown



522
Burgundy Wine



521
Cambro Red



537
Cameo Yellow

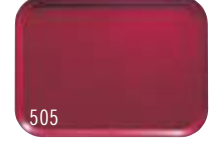

505
Cherry Red



220
Citrus Orange



538
Cottage White



117
Dark Peach



104
Desert Tan



514
Earthen Gold



221
Ever Red

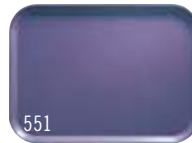

551
Grape



105
Horizon Blue



429
Key Lime



536
Lemon Chiffon



106
Light Peach



113
Lime-ade



504
Mustard



428
Olive Green



222
Orange Pizzazz



107
Pearl Gray



410
Raspberry Cream

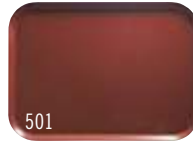

501
Real Rust



518
Robin Egg Blue



119
Sherwood Green



510
Signal Red



177
Sky Blue



401
Slate Blue



508
Suede Brown



199
Taupe



414
Teal



171
Tuscan Gold



148
White

**Due to the catalog printing process, the colors & patterns shown may not be exact.
Contact Cambro or a Cambro representative for a color chip.**

CAMTRAY® GROUP I PATTERNS

Galaxy



526
531
Antique Parchment
Gold (526), Silver (531)

Swirl

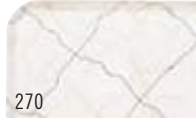

270
Black & Gold **NR**



277
Gray **NR**

Doily



241
Antique Parchment **NR**

Abstract



214
Tan **NR**



215
Gray **NR**

NR Trays are
non-returnable.



CAMTRAY GROUP III WOOD

Wood



308
Burma Teak **NR**



304
Country Oak **NR**



301
Dark Basketweave **NR**



309
Java Teak **NR**

Linen

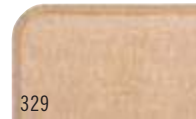

329
Toffee **NR**



302
Light Basketweave **NR**

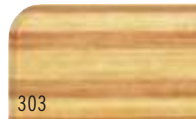

303
Light Butcher Block **NR**



307
Light Elm **NR**



204
Rattan **NR**

NR Trays are
non-returnable.

CAMTRAY GROUP I COLORS – NUMERICAL REFERENCE BY COLOR CODE

Antique Parchment (101),
Desert Tan (104), Horizon Blue (105),
Light Peach (106), Pearl Gray (107),
Black (110), Lime-ade (113),
Brazil Brown (116), Dark Peach (117),
Sherwood Green (119),

Amazon Blue (123), White (148),
Tuscan Gold (171), Sky Blue (177),
Taupe (199), Citrus Orange (220),
Ever Red (221), Orange Pizzazz (222),
Slate Blue (401), Blush (409),
Raspberry Cream (410), Teal (414),

Olive Green (428), Key Lime (429),
Real Rust (501), Mustard (504),
Cherry Red (505), Suede Brown (508),
Signal Red (510), Bayleaf
Brown (513), Earthen Gold (514),

Robin Egg Blue (518), Cambro
Red (521), Burgundy Wine (522),
Lemon Chiffon (536), Cameo
Yellow (537), Cottage White (538),
Grape (551).

Due to the catalog printing process, the colors & patterns shown may not be exact.
Contact Cambro or a Cambro representative for a color chip.

DÉCOR SERIES CAMTRAYS®

- Woodgrain textured surface creates the look feel of real wood.
- Durability of the classic Camtray.
- Ideal for upscale employee feeding, restaurant, cafeteria, schools, food courts and hospitals.
- Personalize a portion or an entire tray surface with a full color logo or design.
- Made of lightweight high-impact fiberglass.
- Commercial dishwasher safe.

Colors: Stonewash Gray (810), Charcoal Gray (815), Light Olive (820), Dark Oak (825), Light Oak (830).

Personalization with a minimum order of 144 trays.



CODE	DIMENSIONS	CASE PACK	LIST PRICE EA.
1216DC	12" x 16"	12	\$ 24.25
1418DC	14" x 18"	12	28.80
1520DC	15" x 20"	12	34.65

Stonewash Gray (810)

Charcoal Gray (815)

Light Olive (820)

DÉCOR SERIES EPICTREAD™ CAMTRAYS

- The Décor Series design and texture with our clear EpicTread non-slip surface.
- Perfect for busy cafeterias to reduce food and dish spills.
- An excellent solution for hospital foodservice to provide a beautiful patient tray presentation without a paper tray mat.
- Personalize a portion or an entire tray surface with a full color logo or design.
- Commercial dishwasher safe.

Colors: Stonewash Gray (810), Charcoal Gray (815), Light Olive (820), Dark Oak (825), Light Oak (830).

Personalization with a minimum order of 144 trays.



Dark Oak (825)

Light Oak (830)

CODE	DIMENSIONS	CASE PACK	LIST PRICE EA.
1216DCET	12" x 16"	12	\$ 30.31
1418DCET	14" x 18"	12	39.25
1520DCET	15" x 20"	12	43.90

NON-SKID VERSA CAMTRAYS®



- Non-Skid Camtrays provide a better grip for safer meal delivery.
- Dishwasher safe in low and high temperatures.
- Stacking lugs keep trays stacked securely in place and ensure proper air flow.
- Ergonomic handles allow for safe and elegant meal delivery.
- Trays fit within existing meal delivery carts, that accommodate 15" x 20" and 14" x 18" trays.

Colors: Black with Pebbled Black (382), Pearl Gray with Titan (381), Ivory with Sahara (380).

Non-Skid Versa Camtrays with Handles are covered by U.S. Patent D 683,191 S.

NSF listed for splash zone only.



Personalization available. Visit www.cambro.com for details.

1418VCH



1418VC

Black with Pebbled Black (382)

Pearl Gray with Titan (381)

Ivory with Sahara (380)

CODE	DIMENSIONS	CASE PACK	LIST PRICE EA.
Non-Skid Versa Camtrays			
1418VC	14" x 18"	12	\$ 39.25
1520VC	15" x 20"	12	43.90
Non-Skid Versa Camtrays with handles			
1418VCH	14" x 18"	12	40.60
1520VCRST	15" x 20"	12	46.20

CAMWEAR® TRAYS

Camwear Trays

- Ideal for use in correctional facilities.
- Made from durable Camwear.
- Stacking lugs keep trays stacked securely in place and ensure proper air flow.

1418CW, 1520CW, 1418TRCW Colors:
Blue (168), Beige (133).

1418CWH, 1520CWH Colors:
Black (110), Smoked Metal (485),
Dark Cranberry (488).

NSF listed for splash zone only.



CODE	DIMENSIONS	CASE PACK	LIST PRICE EA.
Rectangular			
1418CW	13 ¹⁵ / ₁₆ " x 17 ¹⁵ / ₁₆ "	12	\$ 24.95
1520CW	14 ⁷ / ₈ " x 20 ⁷ / ₈ "	12	25.95
Rectangular with Handles			
1418CWH	13 ¹⁵ / ₁₆ " x 17 ¹⁵ / ₁₆ "	12	34.55
1520CWH	14 ⁷ / ₈ " x 20 ⁷ / ₈ "	12	38.65
Trapezoid			
1418TRCW	14" x 18"	12	24.95



Camwear Non-Skid Trays

- Ideal for use in high-traffic cafeterias.
- Made from durable Camwear.
- Non-skid clear textured surface is scratch resistant and ensures drinks and meals stay in place during transport.
- Stacking lugs keep trays stacked securely in place and ensure proper air flow.
- Commercial dishwasher safe at high and low temperatures.

Colors: Black (110), Smoked Metal (485),
Dark Cranberry (488).

These trays are not recommended for use in heated carts.

NSF listed for splash zone only.



Black (110)

Dark Cranberry (488)

Smoked Metal (485)

CODE	DIMENSIONS	CASE PACK	LIST PRICE EA.
Non-skid tray			
1418CWNS	14" x 18"	12	\$ 39.25
1520CWNS	15" x 20"	12	43.90
Non-skid tray with handles			
1418CWNSH	14" x 18"	12	40.60
1520CWNSH	15" x 20"	12	46.20

1418CWNS and 1520CWNS InStock Colors: Black (110), Smoked Metal (485),
Dark Cranberry (488). **1520CWNSH InStock Colors:** Black (110),
Smoked Metal (485).



HOTEL ROOM SERVICE TRAY

- Lightweight, weighs up to 30% less than wood room service trays.
- Dishwasher safe once a day, easily wipes clean. Saves time and labor.
- Standard 14" x 19" tray mat can be used on the surface of the tray.

Colors: Brushed Steel (612), Venge (384), Walnut (376).

NSF listed for splash zone only.

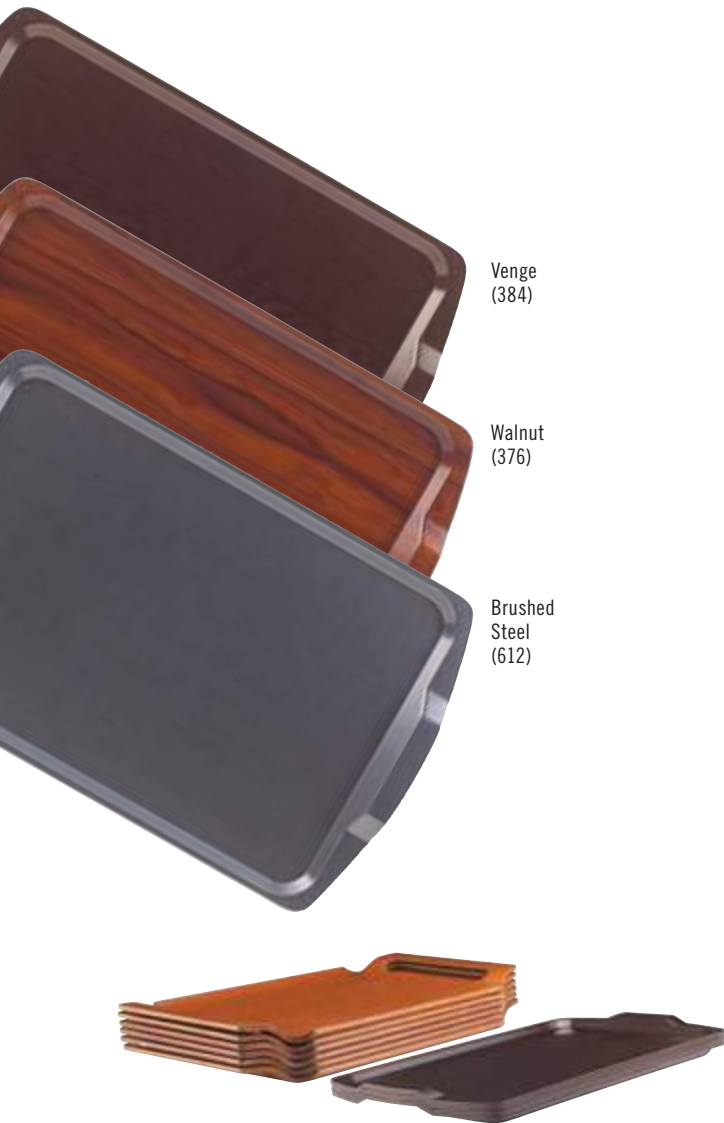

Venge
(384)

Walnut
(376)

Brushed
Steel
(612)

Up to 50% greater stacking capacity than comparable wood trays.



CODE	OUTER DIMENSION	INNER DIMENSION	LIST PRICE EA.
1525RST	15½" x 25"	14" x 21"	\$ 32.40

Case Pack: 12

CAMTREAD® TRAYS

- An industry standard for caterers, hotels, banquet halls, dining rooms and bars.
- Non-skid surface ensures drinks and meals stay in place during transport.
- Made of heavy-duty, durable fiberglass with a thick molded in, non-skid surface.

Orders for non-standard Camtread Tray colors will be handled by special quotation only.

*Special order item not carried in stock, non-returnable. One case order minimum.

Not for use in heated carts.

**Personalization available on 1600CT only.



Non-skid trays mean less breakage and greater profits.



FIVE YEAR PRORATED WARRANTY AGAINST MANUFACTURER'S DEFECTS

Tray Colors:



CODE	DIMENSIONS	CASE PACK	LIST PRICE EA.
Round			
900CT*	9"	12	\$ 19.70
1100CT	11"	12	19.70
1400CT	14"	12	26.20
1550CT*	16" low profile	12	35.60
1600CT**	16"	12	34.55
1800CT	18"	6	49.00
1950CT*	19 ¹ / ₁₆ " low profile	12	50.15
Oval			
2500CT	19 ³ / ₄ " x 23 ³ / ₈ "	6	62.35
2700CT	22" x 26 ⁵ / ₈ "	6	70.20
2900CT	28 ⁷ / ₈ " x 23 ¹ / ₂ "	6	79.65
Rectangular			
1014CT*	10 ⁵ / ₈ " x 13 ³ / ₄ "	12	24.25
1216CT*	12" x 16 ⁵ / ₁₆ "	12	28.05
1418CT	14" x 18"	12	34.90
1520CT*	15" x 20 ¹ / ₄ "	12	39.70
1622CT*	16" x 22"	12	49.00
1826CT	17 ¹³ / ₁₆ " x 25 ¹¹ / ₁₆ "	6	58.80
3253CT*	12 ³ / ₄ " x 20 ⁷ / ₈ "	12	40.85

InStock Colors: Black Satin (110), Tavern Tan (138).
1950CT and 3253CT special order only available in Tavern Tan (138).

TREADLITE™ TRAY

- Fiberglass reinforced polyester lightweight tray has a molded in non-skid surface.
- Non-skid surface ensures items stay in place during service.
- Reinforced edges provide superior strength and protection.
- Stacking lugs keep trays stacked securely in place and ensure proper air flow.



CODE	DIAMETER	LIST PRICE EA.
1400TL	14"	\$ 15.75
1600TL	16"	21.00

Case Pack: 12 InStock Colors: Black Satin (110), Tavern Tan (138).

Tray Colors:



POLYTREAD® TRAYS

- An economical service tray for restaurants, bars and banquet service.
- General, all-purpose, non-skid service trays help reduce spills and breakage.
- Non-skid surface is bonded directly into a lightweight polypropylene tray.
- Stacking lugs keep trays stacked securely in place and ensure proper air flow.



CODE	DIMENSIONS	CASE PACK	LIST PRICE EA.
Round			
PT1100	11"	12	\$ 10.95
PT1400	14"	12	14.70
PT1600	16"	12	19.85
Rectangular			
PT1014	10 ¹ / ₁₆ " x 13 ³ / ₈ "	24	14.10
PT1216	11 ¹ / ₈ " x 16 ¹ / ₄ "	24	15.35
PT1418	14" x 18"	12	19.45



Tray Colors:

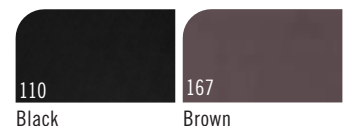

PROMOTE YOUR BRAND – PERSONALIZED CAMTREAD® TRAYS

Personalize Camtread Trays to display a message with every tray served. Advertise a product, a brand or promote your business. Personalized tray orders are full case quantities only, no broken cartons.

Personalization Charges:

QUANTITY EACH	NET CHARGES PER TRAY
144-299	\$ 0.50
300 and up	Free

White trays are recommended for tray back personalization.



Look for this icon that identifies items that can be personalized.

Tray Back – Digital Printing Personalization:

- Multiple color artwork as well as photo reproduction.
- Printable area up to 1" from the external tray edge.
- Available for 1600CT Tray, Black Tread with White Bottom only.
- Order minimum 144 each.



Tray Top – Emboss Personalization:

- Available for all Camtread Trays.
- Embossing area up to 1" from the internal tray edge.
- Order minimum 144 each.

Personalization Charges:

- Custom Emboss Plate \$500.00 Net (one-time charge, billed on first purchase order).
- Embossing Charge: \$1.00 Net per Tray.



HOW TO ORDER A SAMPLE

1. Request a Sample

Contact your local Cambro Representative to complete and submit sample request form to Cambro. Form **MUST BE** submitted along with artwork.

2. Provide Artwork

Must be ready to use, digital format only. Email to Cambro Representative or to Cambro at letsgetpersonal@cambro.com. Title email subject with logo name.

Provide contact info. If artwork is incomplete, graphic services are available for \$50.00 per hour.

File Dimensions:

100% reproduction size, 300 dpi resolution.

File Type:

Adobe® Illustrator®, Photoshop®.

File Format: jpeg, tiff, and eps.

3. Sample Turnaround

7 – 10 business days from approval of artwork.

4. Sample Approval

Approval form included with each sample. Form must be completed and be included with the purchase order for order processing.

5. Sample Charge (NET)

\$50.00 per sample (charge billed on sample order, credited back on first purchase order).

6. Questions?

Contact Kristie Patterson at 714-230-4125 direct, 800-854-7631 Ext. 4125 or email kpatterson@cambro.com.

FAST FOOD TRAY

- Perfect for self-serve or quick-serve dining.
- Made of durable polypropylene.
- Attractive textured surface hides scratches.



Available Colors:



CODE	DIMENSIONS	CASE PACK	LIST PRICE EA.
1014FF	10 ⁷ / ₁₆ " x 13 ³ / ₁₆ "	24	\$ 4.85
1216FF	11 ⁷ / ₈ " x 16 ⁷ / ₈ "	24	5.80
1418FF	13 ¹³ / ₁₆ " x 17 ³ / ₄ "	12	7.45

InStock Colors: Black (110), Red (163).

PROMOTE YOUR BRAND – PERSONALIZED FAST FOOD TRAYS

Personalize Fast Food Trays and display an important message with every tray put into service. Advertise a product or a brand, promote your business or strengthen school spirit. Personalized tray orders are full case quantities only, no broken cartons.

Hot Stamp Personalization

- Single color imprint only.
- Choose from 12 standard imprint colors.
- Maximum imprint size: 5" x 5".
- Print area is 1" from internal side.
- Order minimum 288 each.

QUANTITY EACH	NET CHARGES PER TRAY
288-767	\$ 0.36
768-1199	0.27
1200-5999	0.18
6000-11,999	0.14
12,000 +	0.12

HOW TO ORDER A SAMPLE

1. Request a Sample

Contact your local Cambro Representative to complete and submit sample request form to Cambro. Form MUST BE submitted along with artwork.

2. Provide Artwork

Must be ready to use, digital format only. Email to Cambro Representative or to Cambro at letsgetpersonal@Cambro.com. Title email subject with logo name. Provide contact info. If artwork is incomplete, graphic services are available for \$50.00 per hour.

File Dimensions:

100% reproduction size, 300 dpi resolution.

File Type:

Adobe® Illustrator®, Photoshop®.

File Format: jpeg, tiff, and eps.

3. Sample Turnaround

7 – 10 business days from approval of artwork.

4. Sample Approval

Approval form included with each sample. Form must be completed and be included with the purchase order for order processing.

5. Sample Charge (NET)

\$50.00 per sample (charge billed on sample order, credited back on first purchase order).

6. Custom Die Charge (net)

\$150.00 per die (one-time charge, billed on first purchase order).

7. Questions?

Contact Kristie Patterson at 714-230-4125 direct, 800-854-7631 Ext. 4125 or email kpatterson@Cambro.com.

CHOOSE ONE OR TWO STANDARD IMPRINT COLORS



Due to the catalog printing process, the colors shown may not be exact.



MARKET TRAYS AND PANS

- Attractively merchandise desserts, pastries, hors d'oeuvres and salads.
- Ideal for use in bakeries, supermarkets and delis.
- High-impact resistant fiberglass.
- Trays and pans resist odors and will not oxidize like aluminum trays.
- Pans feature a 2" rim for salads and ready to eat foods.

Colors: Yellow (145)*, Blue (142), Green (140), White (148), Black (110).

*NSF listed for splash zone only.



Market Trays make appealing bakery merchandising quick and easy.



Market Pans showcase deli items.

CODE	DIMENSIONS W x L x D	CASE PACK	LIST PRICE EA.
Market Trays			
630MT	6 ¹ / ₁₆ " x 30" x 3 ³ / ₄ "	12	\$ 21.20
826MT	8 ¹ / ₄ " x 25 ¹ / ₂ " x 3 ³ / ₄ "	12	17.35
830MT	8 ⁷ / ₁₆ " x 30" x 3 ³ / ₄ "	12	23.95
913MT	8 ⁷ / ₈ " x 12 ³ / ₄ " x 1"	12	18.55
918MT	8 ¹¹ / ₁₆ " x 18" x 1 ¹³ / ₁₆ "	12	20.15
926MT	8 ⁷ / ₈ " x 25 ³ / ₁₆ " x 1"	12	22.40
1015MT	10 ⁵ / ₁₆ " x 15" x 3 ³ / ₄ "	24	16.80
1030MT	10 ⁷ / ₁₆ " x 30" x 3 ³ / ₄ "	12	26.50
1218MT	11 ¹ / ₂ " x 17 ³ / ₄ " x 1"	12	20.90
1224MT	12 ⁷ / ₁₆ " x 24" x 3 ³ / ₄ "	12	26.20
1230MT	12 ⁷ / ₁₆ " x 30" x 3 ³ / ₄ "	12	30.45
1318MT	12 ⁵ / ₈ " x 17 ³ / ₄ " x 1 ¹ / ₁₆ "	12	21.50
1826MT	17 ¹³ / ₁₆ " x 25 ¹¹ / ₁₆ " x 1 ¹ / ₁₆ "	6	34.25
2025MT	20 ³ / ₄ " x 25 ¹ / ₁₆ " x 1 ¹³ / ₁₆ "	6	44.80
Market Pans			
6302MT	6 ¹ / ₁₆ " x 30" x 2"	12	33.25
8262MT	8 ³ / ₈ " x 25 ¹ / ₂ " x 2"	12	27.25
8302MT	8 ⁷ / ₁₆ " x 30" x 2"	12	36.60
92615MT	8 ⁷ / ₈ " x 25 ¹ / ₂ " x 1 ¹ / ₂ "	12	22.35
10302MT	10 ⁷ / ₁₆ " x 30" x 2"	12	39.15

Special order item not carried in stock, non-returnable. One case order minimum.

CAMLITE® TRAYS

- An economical, all-purpose tray for self-serve food service dining.
- Made of fiberglass with reinforced corners.
- Stacking lugs keep trays stacked securely in place and ensure proper air flow.

Colors: Rose Red (163), Yellow (145), Green (162), Blue (142), Tan (161), Steel White (676), Steel Red (675), Steel Blue (674), Black (110).



CODE	DIMENSIONS	CASE PACK	LIST PRICE EA.
Rectangular			
1014CL	10 ⁵ / ₈ " x 13 ³ / ₄ "	12	\$ 15.30
1216CL	12" x 16 ⁵ / ₁₆ "	12	17.30
1418CL	14" x 18"	12	19.75
1520CL	15" x 20 ¹ / ₄ "	12	22.55
1826CL	17 ⁷ / ₈ " x 25 ³ / ₄ "	12	32.45
3253CL	12 ³ / ₄ " x 20 ⁵ / ₈ "	12	19.50

COMPARTMENT TRAY

- Perfect for school lunch programs or cafeteria-style feeding in correctional facilities.
- Textured surface resists scratching.
- All are FDA approved for food contact.
- Camwear® is made with virtually unbreakable material.
- Budget is made with ABS.
- Penny-Saver is made with economical co-polymer.

ABS and Co-Polymer trays are not NSF listed.



Cambro Trays

Saves 110 lbs of trash in disposable trays per day or 9.26 tons of trash per year from trays for just one school district.*

*This number is approximate. The average school district in the U.S. is about 10,000 students and the average number of in-session school days is 175.

Camwear Colors



Budget Colors



Penny-Saver Colors



PS1014

150CW, 100CW, 50CW, 45CW, 35CW, 10CW and SRB5CW reusable bowls fit in this tray and can be used to serve cereal, soup & salads.



BCT1014



6.2 oz. 6.2 oz. 5.1 oz.
183,4 mL 183,4 mL 150,8 mL

7.7 oz. 12.1 oz.
227,7 mL 357,8 mL

BCT1014, PS1014 & 10146CW

CODE	DIMENSIONS W x L x D	LIST PRICE EA.
Camwear		
10146CW	10" x 14½" x ¾"	\$ 13.70
Budget - BPA FREE		
BCT1014	10" x 14½" x ¾"	10.65
Penny-Saver - BPA FREE		
PS1014	10" x 14½" x ¾"	6.65

Case Pack: 24









PS1014 on OETR314
Open End Tray Rack.

2 X 2 COMPARTMENT TRAYS

- Perfect for school lunch programs or cafeteria-style feeding in correctional facilities.
- Gradual sloping compartment walls promote quick draining and faster drying.
- "Easy grip" handles ensure a better grip for children with smaller hands.
- 915CW, 100CW, SRB13CW and 50CW bowls fit in round compartment.
- 10CW and 150CW bowls fit in square compartment.

Camwear® trays are NSF Listed.
 Co-Polymer trays are not NSF listed.







 CA PROP 65



Styrofoam, the material that many disposable trays are made from, can make up to 30% of the trash volume in landfills.

Cambro Trays are made from FDA approved materials.

Camwear Colors



Co-Polymer Colors



915CP



1596CW

Personalization Available



915CW and 1596CW inside two PR314 Camracks.

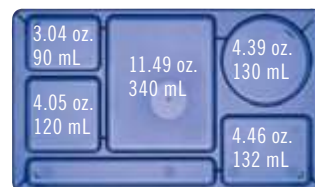

915CW & 915CP

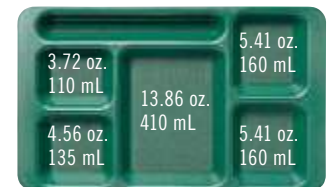

1596CW & 1596CP

CODE	DIMENSIONS W x L x D	LIST PRICE EA.
Camwear		
1596CW	9" x 15" x 7/8"	\$ 12.05
915CW	8 3/4" x 15" x 3/4"	12.05
Co-Polymer - BPA FREE		
1596CP	9" x 15" x 7/8"	7.00
915CP	8 3/4" x 15" x 3/4"	7.00

Case Pack: 24

COMPARTMENT SERVING TRAYS

- For meal delivery in correctional facilities.
- Compartment configurations designed to meet all menu requirements.

Camwear® 6-Compartment Colors: Navy (186), Cranberry (416), Yellow (145), Sherwood Green (119), Beige (133), Black (110).
5-Compartment Colors: Beige (133), Yellow (145).



Co-Polymer Not NSF Listed Color: Tan (161).

Withstands Temperatures From
Camwear: -40° to 210°F.
Co-Polymer: -40° to 160°F.



NT9CP Co-Polymer Cup: For details contact your Cambro representative.



10146CW

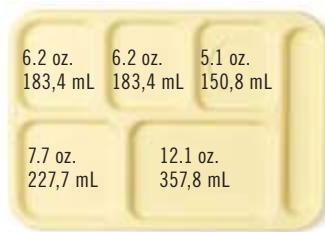

6.2 oz. 183,4 mL
 6.2 oz. 183,4 mL
 5.1 oz. 150,8 mL
 7.7 oz. 227,7 mL
 12.1 oz. 357,8 mL

10146CW



4.3 oz. 127,2 mL
 4.3 oz. 127,2 mL
 9.3 oz. 275 mL
 17.7 oz. 523,5 mL
 9.3 oz. 275 mL

10145CW

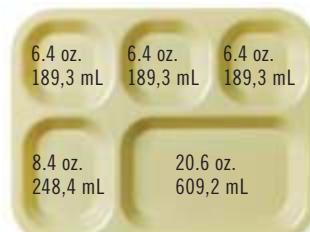

6.4 oz. 189,3 mL
 6.4 oz. 189,3 mL
 6.4 oz. 189,3 mL
 8.4 oz. 248,4 mL
 20.6 oz. 609,2 mL

14105CW and 14105CP

Camwear Colors



119 Sherwood Green



145 Yellow



416 Cranberry



133 Beige



186 Navy Blue



110 Black

Co-Polymer Color



161 Tan

CODE	DESCRIPTION	DIMENSIONS W x L x D	LIST PRICE EA.
Camwear			
10146CW	6 Compartments	10" x 14½" x 1½"	\$ 13.70
14105CW	5 Compartments	10½" x 13⅞" x 1½"	15.00
10145CW	5 Compartments	10" x 14½" x 1½"	14.95
Co-Polymer - BPA FREE			
14105CP	5 Compartments	10½" x 13⅞" x 1½"	7.10

Case Pack: 24

TRAPEZOID COMPARTMENT TRAY

- Space saving tray for self serve correctional facility feeding.
- Offers seven deep compartments for ample, portion controlled servings.
- Serve soup and salad at the same time.

Camwear Color: Beige (133).

Withstands Temperatures From
Camwear: -40° to 210°F.

Trapezoid Compartment Trays are covered by the following U.S. Patent D 508,634.

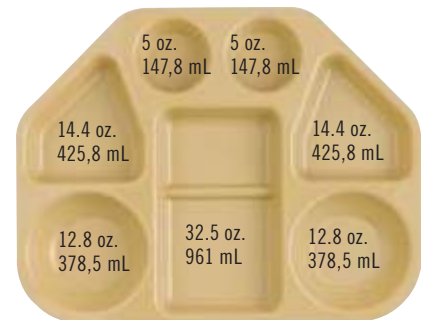

5 oz. 147,8 mL
 5 oz. 147,8 mL
 14.4 oz. 425,8 mL
 14.4 oz. 425,8 mL
 12.8 oz. 378,5 mL
 32.5 oz. 961 mL
 12.8 oz. 378,5 mL



Camwear Color



133 Beige

CODE	DESCRIPTION	DIMENSIONS W x L x D	LIST PRICE EA.
Camwear Trapezoid Tray			
14187RCW	7 Compartments	14" x 17½" x 1½"	\$ 26.90

Case Pack: 12

MEAL DELIVERY TRAYS

- Three deep-dish food compartments for large portions.
- Snap-on cover fits securely.
- Textured surface minimizes scratching.

Camwear® Colors:
Beige (133), Teal (414).
Lid Color: Clear (135).



Co-Polymer Not NSF Listed Colors:
Teal (414), Brown (167), Tan (161).
Lid Color: White (148).

Withstands Temperatures From
Camwear: -40° to 210°F.
Co-Polymer: -40° to 160°F.



Camwear Colors

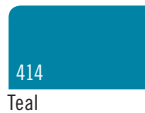

Co-Polymer Colors

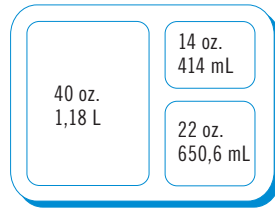
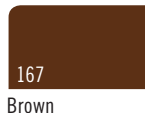

9113CW/9113CP

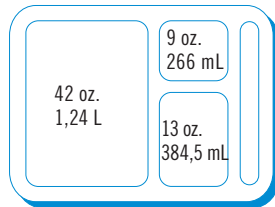

9114CW/9114CP

CODE	DESCRIPTION	DIMENSIONS W x L x D	LIST PRICE EA.
Camwear			
9113CW	3 Compartments	9" x 11" x 2 ¹ / ₁₆ "	\$ 16.05
9114CW	4 Compartments	9" x 11" x 2 ¹ / ₁₆ "	16.75
911CWC	Lid fits both trays	9" x 11" x 3/ ₁₆ "	11.35
Co-Polymer - BPA FREE			
9113CP	3 Compartments	8 ⁷ / ₈ " x 10 ¹ / ₁₆ " x 2 ⁵ / ₈ "	7.25
9114CP	4 Compartments	8 ¹⁵ / ₁₆ " x 10 ³ / ₄ " x 2 ⁵ / ₈ "	7.25
911CPC	Lid fits both trays	8 ¹⁵ / ₁₆ " x 10 ¹³ / ₁₆ " x 9/ ₁₆ "	3.95

Case Pack: 24

SEPARATOR® COMPARTMENT TRAY

- Six compartment tray designed specifically for in-cell feeding programs.
- Serve both hot and cold food from the same tray.
- Tray with cover separates each compartment to retain food temperature and reduce spills.
- Locking ridges on top of cover and bottom of tray ensure more secure stacking.

Camwear Color: Beige (133).
Lid Color: Clear (135).



Co-Polymer Not NSF Listed Colors:
Teal (414), Brown (167), Tan (161).
Lid Color: Translucent (190).

Withstands Temperatures From
Camwear: -40° to 210°F.
Co-Polymer: -40° to 160°F.



10146DCW



10146DCP

Camwear Color



Co-Polymer Colors

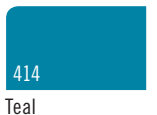
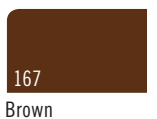
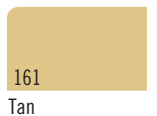

CODE	DESCRIPTION	DIMENSIONS W x L x D	LIST PRICE EA.
Camwear			
10146DCW	6 Compartments	10" x 14 ³ / ₁₆ " x 1 ¹ / ₁₆ "	\$ 17.60
10146DCWC	Lid fits 10146DCW	10 ³ / ₄ " x 14 ³ / ₄ " x 1 ¹ / ₁₆ "	9.35
Co-Polymer - BPA FREE			
10146DCP	6 Compartments	9 ¹⁵ / ₁₆ " x 13 ¹⁵ / ₁₆ " x 1 ¹ / ₁₆ "	9.25
10146DCPC	Lid fits 10146DCP	10 ¹ / ₁₆ " x 14 ¹ / ₁₆ " x 1 ¹ / ₁₆ "	5.40

Case Pack: 24



TRAY ON TRAY MEAL DELIVERY SYSTEM

Base Tray

- Combine hot and cold food portions into a reusable, single service unit.
- Works as a tray or for in-cell feeding with the insert tray.
- Base tray has 5 compartments with 1 compartment for nesting the insert tray.

Camwear® Color: Beige (133).



Co-Polymer Not NSF Listed Colors: Brown (167), Tan (161).

Withstands Temperatures From

Camwear: -40° to 210°F.

Co-Polymer: -40° to 160°F.



1411CW



1411CW base tray with 853FH insert tray

Camwear Color

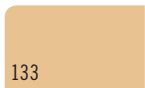

133
Beige

Co-Polymer Colors

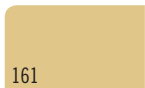

161
Tan

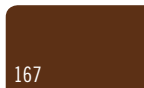

167
Brown

11.8 oz. 349 mL	6.7 oz. 198,1 mL	6.7 oz. 198,1 mL
11.8 oz. 349 mL	23.6 oz. 697,9 mL	

1411CW/1411CP

CODE	DESCRIPTION	DIMENSIONS W x L x D	LIST PRICE EA.
Camwear			
1411CW	5 Compartments	10 ⁹ / ₁₆ " x 14 ³ / ₈ " x 1 ¹ / ₄ "	\$ 17.50
Co-Polymer - BPA FREE			
1411CP	5 Compartments	10 ⁹ / ₁₆ " x 14 ³ / ₈ " x 1 ¹ / ₄ "	6.55

Case Pack: 24

Insert Trays

- Eight trays efficiently fit on a standard sheet pan or in an 18" x 26" (45,5 x 65,5 cm) wire rack.

Camwear Color: Beige (133).

Lid Color: Clear (135).



Co-Polymer Not NSF Listed Colors:

Brown (167), Tan (161).

Lid Color: Translucent (190).

Heat Resistant Plastic Tray and

Lid Color: Amber (150).

Withstands Temperatures From

Camwear: -40° to 210°F.

Co-Polymer: -40° to 160°F.

Heat Resistant Plastic:

-40° to 375°F.



853FCW



853FCP

Camwear Color



133
Beige

Co-Polymer Colors

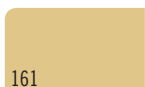

161
Tan



167
Brown

Heat Resistant Plastic Color

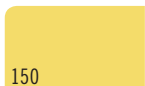

150
Amber

7 oz. 207 mL	21 oz. 621 mL
7 oz. 207 mL	

CODE	DESCRIPTION	DIMENSIONS W x L x D	LIST PRICE EA.
Camwear			
853FCW	3 Compartments	6 ⁵ / ₁₆ " x 8 ¹¹ / ₁₆ " x 1 ¹ / ₈ "	\$ 11.35
853FCWC	Lid for 853FCW	6 ³ / ₄ " x 8 ¹³ / ₁₆ " x 1 ¹ / ₄ "	6.00
Co-Polymer - BPA FREE			
853FCP	3 Compartments	6 ¹ / ₄ " x 8 ⁹ / ₁₆ " x 1 ¹ / ₈ "	5.80
853FCPC	Lid for 853FCP	6 ³ / ₄ " x 8 ¹³ / ₁₆ " x 1 ¹ / ₄ "	3.10
Heat Resistant Plastic			
853FH	3 Compartments	6 ⁵ / ₁₆ " x 8 ¹¹ / ₁₆ " x 1 ¹ / ₈ "	23.55
853FHC	Lid for 853FH	6 ³ / ₄ " x 8 ¹³ / ₁₆ " x 1 ¹ / ₄ "	13.55

Case Pack: 24

HEALTHCARE



NON-SKID VERSA CAMTRAYS®

- Non-Skid Trays reduce waste, save money and provide a stable tray surface for meal delivery.
- Switching from paper tray mats will generate annual savings of over 50%.
- Green initiatives will get rapid results with the elimination of tons of trash each year.
- Non-Skid Camtrays provide a better grip for safer meal delivery.
- Dishwasher safe in low and high temperatures.
- Stacking lugs keep trays in place and ensure proper airflow between trays.

Colors:
 Black with Pebbled Black (382),
 Pearl Gray with Titan (381),
 Ivory with Sahara (380).

.....
 NSF Listed for splash zone only.

 Personalization available.
 Visit www.cambro.com for details.



Non-skid trays grip tray top items firmly.



CODE	DESCRIPTION	DIMENSIONS	LIST PRICE EA.
1418VC	Non-Skid Versa Camtray	14" x 18"	\$ 39.25
1520VC	Non-Skid Versa Camtray	15" x 20"	43.90

Case Pack: 12

Visit www.cambro.com/savemoney to see how much you can save by eliminating your purchase of paper mats.

Black with Pebbled Black (382)

Pearl Gray with Titan (381)

Ivory with Sahara (380)

NON-SKID VERSA CAMTRAYS WITH HANDLES

- Ergonomic handles allow for safe and elegant meal delivery.
- Non-skid surface eliminates the need for tray mats saving time and money.
- Trays fit within existing meal delivery carts that accommodate 14" x 18" or 15" x 20" trays.
- Dishwasher safe at high and low temperatures.
- Stacking lugs keep trays in place and ensure proper airflow between trays.
- 15" x 20" tray is ideal for room service.

Colors:
 Black with Pebbled Black (382),
 Pearl Gray with Titan (381),
 Ivory with Sahara (380).

.....
 Non-Skid Versa Camtrays for Room Service with Handles are covered by U.S. Patent D 683,191 S.

 NSF Listed for splash zone only.

 Personalization available.
 Visit www.cambro.com for details.



CODE	DESCRIPTION	DIMENSIONS	LIST PRICE EA.
1418VCH	Non-Skid Versa Camtray with handles	14" x 18"	\$ 40.60
1520VCRST	Non-Skid Versa Camtray with handles	15" x 20"	46.20

Case Pack: 12

CAMWEAR® TRAYS AND NON-SKID TRAYS

- Ideal for patient meal delivery and in high-traffic cafeterias.
- Scratch-resistant, made of durable Camwear.
- Non-skid surface eliminates the need for tray mats, saving time and money.
- Enhances stability, providing safer transport and service.
- Stacking lugs keep trays in place and ensure proper airflow between trays.
- Commercial dishwasher safe at high and low temperatures.
- Trays with handles are also available without non-skid surface.

Colors: Black (110), Dark Cranberry (488), Smoked Metal (485).

Not recommended for use in heated carts.

NSF Listed for splash zone only.



1520CWNSH

Black (110)

Dark Cranberry (488)

Smoked Metal (485)

CODE	DESCRIPTION	DIMENSIONS	LIST PRICE EA.
Non-Skid Trays			
1418CWNS	Without handles	14" x 18"	\$ 39.25
1520CWNS	Without handles	15" x 20"	43.90
1418CWNSH	With handles	14" x 18"	40.60
1520CWNSH	With handles	15" x 20"	46.20
Camwear Trays			
1418CWH	With handles	14" x 18"	34.55
1520CWH	With handles	15" x 20"	38.65

Case Pack: 12 1418CWNS, 1520CWNS **InStock Color:** Black (110), Smoked Metal (485), Dark Cranberry (488).

1520CWNSH InStock Color: Black (110), Smoked Metal (485).



1520CWNSH

DÉCOR SERIES EPICTREAD™ CAMTRAYS

- Provides the appearance of authentic wood grain, perfect modern healthcare facilities.
- Tray surface is embedded with clear EpicTread non-slip material, providing safe and spill-free patient meal delivery.
- EpicTread eliminates the use of tray mats, saving cost, waste and labor.

- Personalize a portion or an entire tray surface with a full color logo or design.
- Commercial dishwasher safe.

Colors: Stonewash Gray (810), Charcoal Gray (815), Light Olive (820), Dark Oak (825), Light Oak (830).

Personalization with a minimum order of 144 trays.



CODE	DIMENSIONS	CASE PACK	LIST PRICE EA.
1216DCET	12" x 16"	12	\$ 30.31
1418DCET	14" x 18"	12	39.25
1520DCET	15" x 20"	12	43.90



Stonewash Gray (810)

Charcoal Gray (815)

Light Olive (820)

Dark Oak (825)

Light Oak (830)



MEAL DELIVERY WARE SYSTEM – THE HARBOR COLLECTION

- Attractive design provides a pleasant dining experience.
- Supports temperature maintenance.
- Available in six popular colors to complement any decor.
- Mugs and bowls fit Cambro disposable CamLids®.
- Made of durable polypropylene, won't chip or break.
- High temperature dishwasher safe.
- Dome fits 9" plate.
- Works with all Cambro Temperature Retention Systems, Camduction® Complete Heat System, Camtherm® Thermal Pellet System, Heat Keeper Insulating Base System and Camchiller® Pellet System.

Cambro insulated ware is not recommended for use in a microwave oven as this will increase the likelihood of staining and cracking, neither of which is covered under the manufacturers warranty.

Insulated Harbor bowl is covered by U.S. Patent D795,017 S.



Ergonomically correct handle fits three adult fingers.



CODE	MDSHD9	MDSHB5	MDSHB9	MDSHM8
DESCRIPTION	Insulated dome cover for 9" plate	Insulated small bowl	Insulated large bowl	Insulated mug
LID CODE	—	CLSM8B5, CLRSM8B5	CLSB9, CLRSB9	CLSSM8B5, CLSM8B5, CLRSM8B5
APPROX. CAPACITY	—	5 oz.	9 oz.	8 oz.
OUTSIDE DIAMETER	10¼"	3½"	4¾"	4½"
HEIGHT	3⅜"	2⅝"	2⅝"	4"
FULL-SIZE CAMRACK®	PR59314	16C414	9S318	16C414
CASE PACK	12	48	48	48
LIST PRICE EACH	\$ 19.10	\$ 3.25	\$ 3.25	\$ 3.25

InStock Color: Smoked Metal (485).

Harbor Meal Delivery Ware Colors:



110

Black



447

Meadow



485

Smoked Metal



487

Cranberry



148

White

New!



497

Navy Blue

CLASSIC WHITE CERAMIC WARE

- Enhance dining experience with ceramic plates and bowls.
- Protect contents in bowls with disposable CamLids.
- Enhance operational efficiency: microwave, oven and freezer safe.
- Meets Society of Glass and Ceramic Decorators (SGCD) heavy metal standards.

Color: White (148)
Disposable CamLids Color: Translucent (190)

No Broken Cartons.



CODE	MDSM8CNL	MDSB5C	MDSB9C	MDSPLT9
DESCRIPTION	Ceramic Contoured Mug	Ceramic Small Bowl	Ceramic Large Bowl	Ceramic Plate
APPROX. CAPACITY TO RIM	8 oz.	5 oz.	9 oz.	—
OUTSIDE DIAMETER	4¾" with handle	3½"	4¾"	9"
HEIGHT	3⅜"	2¼"	2⅝"	1"
CAMLID CODE	CLNT12 with Straw Slot	CLSM8B5	CLSB9	—
CASE PACK	48	48	48	24
LIST PRICE PER CASE	\$ 372.00	\$ 180.00	\$ 230.40	\$ 194.65



MEAL DELIVERY WARE SYSTEM – THE SHORELINE COLLECTION

- Classic design, high performance, and unequalled safety at a budget-friendly price.
- Works with all Cambro Temperature Retention Systems, Camduction® Complete Heat System, Camtherm® Thermal Pellet System, Heat Keeper Insulating Base System and Camchiller® Pellet System.
- Mugs and bowls fit Cambro disposable CamLids®.
- Domes and delivery ware are made of durable polypropylene.

Cambro insulated ware is not recommended for use in a microwave oven as this will increase the likelihood of staining and cracking, neither of which is covered under the manufacturers warranty.



Insulated Meal Delivery Ware



CODE	MDS09	MDSL09	MDSM8	MDSB5	MDSB9	MDSB16
DESCRIPTION	Insulated dome covers 9" plate	Low profile insulated dome covers 9" plate	Mug	Sm. bowl	Lg. bowl	Entree bowl
LID CODE	—	—	CLSSM8B5, CLSM8B5, CLRSM8B5	CLSSM8B5, CLSM8B5, CLRSM8B5	CLSB9, CLRSB9	CLRSB16
APPROX. CAPACITY	—	—	8 oz.	5 oz.	9 oz.	16.9 oz.
OUTSIDE DIAMETER	10¼"	10¼"	3½" *	3½"	4¾"	5¾"
HEIGHT	3¾"	2¾"	4"	2⅝"	2⅝"	2⅝"
FULL-SIZE CAMRACK®	PR59314	PR59314	16C414	16C414	9S318	9S318
CASE PACK	12	12	48	48	48	48
LIST PRICE EACH	\$ 19.10	\$ 14.40	\$ 3.25	\$ 3.25	\$ 3.25	\$ 6.35

*MDSM8 Diameter 4½" with Handle. **InStock Colors.

Shoreline Meal Delivery Ware Colors:



Disposable Lids for Meal Delivery Ware



LID CODE	CLSM8B5	CLSB9	CLSSM8B5
DESCRIPTION	Sm. disp. lid	Lg. disp. lid	Disp. sip lid
FITS	MDSB5, MDSM8, MDSHB5	MDSB9, MDSHB9	MDSB5, MDSM8, MDSHM8
OUTSIDE DIAMETER	3⅞"	4⅞"	3⅞"
HEIGHT	⅝"	⅝"	1⅞"
CASE PACK	1,500	1,000	1,000
LIST PRICE PER CASE	\$ 97.65	\$ 81.90	\$ 81.90

CLSM8B5, CLSB9 Color: Translucent (190). CLSSM8B5 Color: White (148).
Sold in full cases only. No broken cartons.



TEMPERATURE RETENTION SYSTEMS

Cambro offers an array of products that support a variety of temperature retention systems. As each facility has its own separate needs and challenges, different serving solutions are needed.

MDCDB9, HK39B, MDSL9, and MDS09
Colors: Meadow (447), Wheat (457), Speckled Gray (480), Cranberry (487), Navy Blue (497), Black (110), Smoked Metal (485)*.

MDSPC9 Color: Black (110).

MDSP9 Color: Dark Gray (477).

MDSPL Color: (000).

*Only available for Harbor Dome and Camduction Base.

MDSPL not NSF listed.

MDCDB9 is covered by U.S. Patent D 630, 8975 S. and 8,263,906 B2.



Camduction®



- A. Insulated Dome
- B. 9" Ceramic Plate
- C. Camduction Base

Insulated Base



- A. Insulated Dome
- B. 9" Ceramic Plate
- C. Heat Keeper Insulated Base

Thermal Pellet

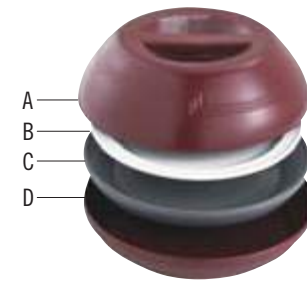

- A. Insulated Dome
- B. 9" Ceramic Plate
- C. Hot Thermal Pellet
- D. Underliner

Cold Pellet

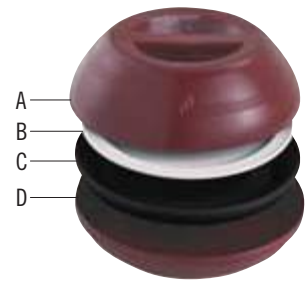

- A. Insulated Dome
- B. 9" Ceramic Plate
- C. Cold Pellet
- D. Underliner

Camduction Complete Heat System

The most efficient heat retention solution, holds hot food at safe temperatures 140°F or higher for up to 60 minutes.

- Camduction Bases are durable and dishwasher safe.
- Resistant to chips, cracks and breaks.
- Revolutionary technology eliminates errors or issues with spikes in voltage.



MDCDB9

Camduction base holds 9" plate

OUTSIDE DIAMETER: 9³/₁₆"

OUTSIDE HEIGHT: 1¹⁵/₁₆"

FULL-SIZE CAMRACK®: PR59314

LIST PRICE EACH: \$ 97.85

Case Pack: 12

Heat Keeper Insulating Base System

The cost-effective solution for heat retention, holds temperature for 20 minutes or more.

- Resists stains, odors and scratches.



HK39B

Insulating base holds 9" plate

OUTSIDE DIAMETER: 9⁵/₈"

OUTSIDE HEIGHT: 1⁵/₈"

FULL-SIZE CAMRACK®: PR59314

LIST PRICE EACH: \$ 10.95

Case Pack: 12

TEMPERATURE RETENTION SYSTEMS

Camtherm® Thermal Pellet System

The perfect choice for maximum heat retention, holds temperature for 60 minutes or more.

- Holds heat at its core to keep hot foods at safe temperatures.
- Stays 20°F cooler on the edge than metal pellets to protect staff and patients from burns.
- Is a high-density plastic material that won't dent like metal pellets.



MDSP9
Thermal pellet holds 9" plate
OUTSIDE DIAMETER: 9½"
OUTSIDE HEIGHT: 1¾"
FULL-SIZE CAMRACK®: PR59314
LIST PRICE EACH: \$ 44.65
Case Pack: 12



MD SL9
Pellet underliner holds 9½" pellet
OUTSIDE DIAMETER: 9⅞"
OUTSIDE HEIGHT: 1⅙"
FULL-SIZE CAMRACK: PR59314
LIST PRICE EACH: \$ 8.65
Case Pack: 12



MDSPL
Camtherm thermal pellet lifter
OUTSIDE DIAMETER: 3⅞"
OUTSIDE HEIGHT: 3"
LIST PRICE EACH: \$ 84.35
Case Pack: 1

Camchiller® Pellet System

Keeps cold food below or at 40°F for up to 45 minutes when used with a chilled plate and insulated dome.

- Shatter-resistant at freezing temperature.
- Stackable for easy transport and storage.
- Can be used with or without an underliner.
- High-temperature dishwasher safe.



MDSPC9
Camchiller pellet holds 9" plate
OUTSIDE DIAMETER: 9½"
OUTSIDE HEIGHT: 1⅜"
FULL-SIZE CAMRACK: PR59314
LIST PRICE EACH: \$ 30.90
Case Pack: 12



MDSL9
Pellet underliner holds 9½" pellet
OUTSIDE DIAMETER: 9⅞"
OUTSIDE HEIGHT: 1⅙"
FULL-SIZE CAMRACK: PR59314
LIST PRICE EACH: \$ 8.65
Case Pack: 12

Domes, Plate Cover and Plate for all Cambro Temperature Retention Systems



CODE	MDSD9 (NSF)	MDSL9 (NSF)	MDSHD9 (NSF)	909CW (NSF)	MDSPLT9
DESCRIPTION	Insulated dome covers 9" plate	Low profile insulated dome covers 9" plate	Insulated dome cover for 9" plate	Camwear® Camcover®	Ceramic plate
OUTSIDE DIAMETER	10¼"	10¼"	10¼"	10⅞"	9"
OUTSIDE HEIGHT	3⅜"	2¾"	3⅜"	2¾"	1"
FULL-SIZE CAMRACK	PR59314	PR59314	PR59314	PR59314	PR314
CASE PACK	12	12	12	12	24
LIST PRICE EACH	\$ 19.10	\$ 14.40	\$ 19.10	\$ 10.75	\$ 194.65 / case

MDSD9, MDSL9 and MDSHD9 Colors: Meadow (447), Wheat (457), Speckled Gray (480), Cranberry (487), Navy Blue (497), Black (110), Smoked Metal (485)*.
909CW Colors: Clear (152), Amber (153), Beige (133), Silver (486). **MDSPLT9 Color:** White (148). *Smoked Meal (485) only available for Harbor Dome.
 MDSPLT9 Sold in full cases only.



HEALTHCARE TUMBLER, SWIRL BOWL AND DISPOSABLE CAMLIDS®

Lido® Tumblers with Disposable Lids



The 6 & 9 ounce Lido tumblers are marked with 2 ounce increments from the top down for easy patient liquid intake recording.

TUMBLER CODE	LDT6	LDT9
LID CODE	CLST6	CL900P
TUMBLER CAPACITY	6 oz.	9 oz.
CASE PACK TUMBLER / LID	36 / 1,000	36 / 1,000
LIST PRICE PER CASE TUMBLER / LID	\$ 68.40 / \$ 69.60	\$ 79.20 / \$ 97.75

Color: Translucent (190). Sold in full cases only. No broken cartons.

Laguna® Tumblers with Disposable Lids



Swirl Bowl with Disposable Lids



TUMBLER CODE	LT6	LT10	LT12
LID CODE	CLLT6	CLLT10	CLLT12
TUMBLER CAPACITY	6 oz.	10 oz.	12 oz.
CASE PACK TUMBLER / LID	36 / 1,500	36 / 1,000	36 / 1,000
LIST PRICE PER CASE TUMBLER / LID	\$ 72.00 / \$ 110.25	\$ 81.00 / \$ 89.25	\$ 88.20 / \$ 97.75

Color: Translucent (190). Sold in full cases only. No broken cartons.

SWIRL BOWL CODE	SRB5CW (SRB5)
LID CODE	CLSRB5
SWIRL BOWL CAPACITY	5 oz.
CASE PACK BOWL / LID	24 / 1,000
LIST PRICE PER CASE BOWL / LID	\$ 54.00 (46.80) / \$ 146.45

Color: Clear (152). Made of (P.E.T.). Sold in full cases only. No broken cartons.

Colorware Tumblers with Disposable Lids



TUMBLER CODE	500P (500P2)	800P (800P2)	900P (900P2)	950P (950P2)
LID CODE	CLJ6	CL800P	CL900P	CL950P
TUMBLER CAPACITY	5.2 oz.	8 oz.	9.7 oz.	9.8 oz.
CASE PACK TUMBLER / LID	72 / 24 / 1,000	72 / 24 / 1,000	72 / 24 / 1,000	72 / 24 / 1,000
LIST PRICE PER CASE TUMBLER / LID	\$ 75.60 (26.40) / \$ 66.60	\$ 90.00 (32.40) / \$ 76.55	\$ 154.80 (56.40) / \$ 97.75	\$ 104.40 (38.40) / \$ 71.30

Color: Translucent (190). Sold in full cases only. No broken cartons.

Newport Tumblers with Disposable Lids



TUMBLER CODE	NT5	NT8	NT9	NT10	NT12
LID CODE	CLNT5	CLNT8	CLNT9	CLNT10	CLNT12
TUMBLER CAPACITY	6.4 oz.	8 oz.	9 oz.	10 oz.	12.6 oz.
CASE PACK TUMBLER / LID	36 / 1,500	36 / 1,000	36 / 1,000	36 / 1,000	36 / 1,000
LIST PRICE PER CASE TUMBLER / LID	\$ 57.60 / \$ 110.25	\$ 59.40 / \$ 69.60	\$ 64.80 / \$ 97.75	\$ 70.20 / \$ 89.25	\$ 73.80 / \$ 97.75

Color: Translucent (190). Sold in full cases only. No broken cartons.



CAMDUCTION® COMPLETE HEAT SYSTEM – HOT MEAL DELIVERY SYSTEM

Camduction innovative hot meal delivery system is fast and efficient. Camduction is perfect for any facility with a hot tray line system.

Camduction Charger covered by U.S. Patent 8,263,906 B2.
Camduction Base covered by U.S. Patent D630,897 S.

Camduction Charger comes with 1 year warranty.



Food Temperature Retention

*When used with heated plate, dome and Camduction Base.

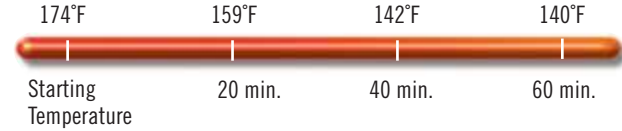

Quickly and efficiently heats up to 20 Camduction bases at one time. Initial start-up takes approximately 4 - 6 minutes.

Supports up to 5 trays per minute, improving operational efficiency.

Holds hot foods safe at 140°F or higher for up to 60 minutes. Based on voltage supply.

Energy efficient unit turns off after 60 minutes of inactivity.

Camduction charger is made of high-grade, durable stainless steel that remains cool to the touch.

Easy to operate: Red Slot LED indicates bases are heating. Green light indicates ready.

Independent functionality of each compartment reduces the risk of service interruption.

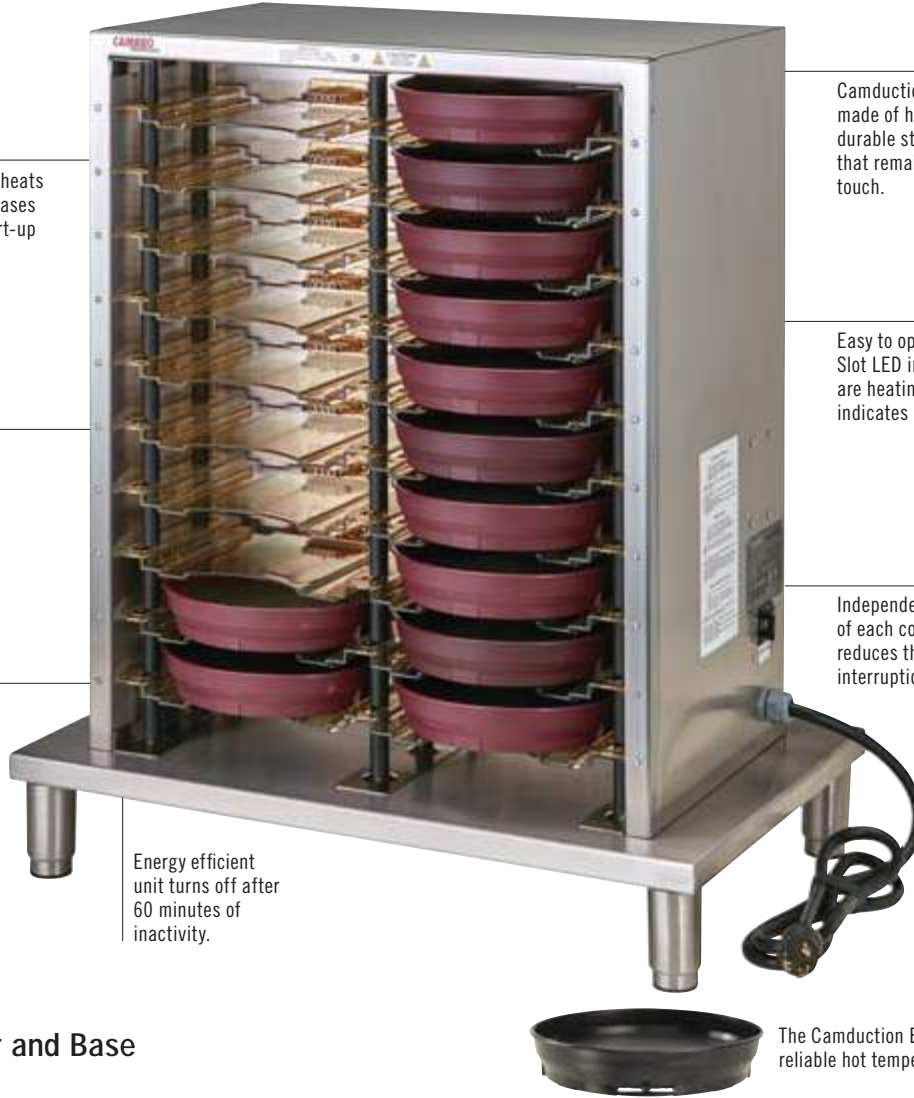

Camduction Charger and Base

CODE	MDSCDC9X1
DESCRIPTION	Camduction base charger, single phase
CAPACITY	20 Bases
OVERALL DIMENSIONS W x D x H	30" x 18 ⁷ / ₈ " x 34 ³ / ₈ "
VOLTAGE / PHASE	208-240 VAC, Single Phase
AMPS / HERTZ	18a, 50/60
PLUG CONFIGURATION	NEMA L6-30P
ELECTRICAL CORD	6 feet
INITIAL HEAT UP TIME	4 - 6 minutes*
ALL INDICATOR LIGHTS	LED
UNIT WEIGHT	108 lbs.
LIST PRICE EACH	\$ 8,500.00

Case Pack: 1 Color: Stainless Steel (000).

CODE	MDSCDB9 
DESCRIPTION	Camduction base holds 9" plate
OUTSIDE DIAMETER	9 ⁹ / ₁₆ "
OUTSIDE HEIGHT	1 ¹⁵ / ₁₆ "
FULL-SIZE CAMRACK®	PR59314
CASE PACK	12
LIST PRICE EACH	\$ 97.85



The Camduction Base provides reliable hot temperature retention.

CAMTHERM® PLATE HEATER

- Heats plates up to proper temperatures to help keep foods hot longer, increase food quality and enhance patient satisfaction scores.
- Insulation keeps exterior cool to the touch.
- Delivers reliable and convected air heating throughout the unit.
- Self-leveling plate dispensers hold up to 100 plates.
- Fits ceramic or china plates up to 10.5" in diameter.
- Energy savings with independent temperature control for each silo.

Color: Stainless Steel (000).



CODE	CHPL100
DESCRIPTION	Plate heater
NUMBER OF SILOS	2
CAPACITY	100 plates (50 in each side)
DIMENSIONS W x D x H	39 ³ / ₄ " x 26 ¹ / ₂ " x 39 ⁷ / ₈ "
VOLTAGE/PHASE	208-240 VAC
AMPS / HERTZ	10.5a, 50/60
WATTS	2400
ELECTRICAL CORD	6 feet
NEMA PLUG CONFIGURATION	6-15
TEMPERATURE RANGE	80° - 175°F
PRODUCT WEIGHT	356 lbs.
LIST PRICE EACH	\$ 8,925.00

Case Pack: 1



CHPL100

REUSABLE CAMLIDS®

- Save up to 75% in lid costs each year.
- Reduce your waste-stream by tons each year when you switch from disposables to reusables.
- Dishwasher safe.
- Made of durable polypropylene.
- Fits both Shoreline and Harbor Collection mugs and bowls.



CAMRACK® WASH AND STORE RACK

- Designed for safe and secure washing and storing of reusable CamLids, CLRSB9 and CLRSM8B5 only.
- Holds 36 reusable CamLids.
- 2 Wash and store racks fit in a full size base rack with 2 extenders.



Visit www.cambro.com/savemoney for a Customized Savings Calculator!

Reusable CamLids Color: Speckled White (490).
Camrack Wash and Store Rack Color: Kelly Green (452).
Camrack Base Full Size InStock Color: Soft Gray (151).
Full Rack Cover InStock Color: Gray (180).

CLRWSR36 is covered under U.S. patent D 617,069.
 Full Rack Cover not NSF certified.



CODE	DESCRIPTION	DIMENSIONS	CASE PACK	LIST PRICE EA.
Reusable CamLids		H x DIA.		
CLRSM8B5	Fits 8 oz. mug and 5 oz. bowl	2 ¹ / ₄ " x 3 ³ / ₁₆ "	240	\$ 122.55
CLRSB9	Fits 9 oz. bowl	2 ¹ / ₄ " x 4 ⁷ / ₁₆ "	240	163.25
CLRSB16	Fits 16 oz. bowl	2 ¹ / ₄ " x 5 ¹ / ₂ "	240	267.80
Accessories for CLRSM8B5 and CLRSB9		L x W x H		
CLRWSR36	Camrack wash and store rack for reusable lids	8 ³ / ₄ " x 17 ⁷ / ₈ " x 5 ¹ / ₂ "	4	25.65
BR578	Camrack full size base rack with 2 extenders	19 ³ / ₄ " x 19 ³ / ₄ " x 7 ¹ / ₄ "	4	71.40
DRC2020	Full rack cover	19 ⁵ / ₈ " x 19 ⁵ / ₈ " x 1 ¹⁵ / ₁₆ "	1	57.20
Accessories for CLRSB16		L x W x H		
PR500	9 x 9 peg rack with 1 extender	19 ³ / ₄ " x 19 ³ / ₄ " x 5 ⁵ / ₈ "	5	58.60
E3	Full size open extender	19 ³ / ₄ " x 19 ³ / ₄ " x 2"	12	14.15
CRPHDG2878	Full size square hold down grid	18 ³ / ₈ " x 18 ³ / ₈ "	6	27.95

Reusable CamLids sold in full cases only. No broken cartons.

AIR CURTAIN ULTRA™

The Air Curtain Ultra is a necessity for any Healthcare Room Service or Tray line operation. The ACU offers mobile refrigeration that can maintain cabinet temperatures of 40°F or below for 2 hours with the door open*. Perfect for staging cold sides, deserts, drinks or salads in your tray assembly area; operators can quickly access these items without risking temperature issues. Combine with our Camduction® system, Camtherm® Plate Heater and the rest of our healthcare product offering to fill your patient service needs.

- Stainless steel construction with welded base frame provides durability.
- Fully insulated cabinet and door for cooling efficiency.
- Multi directional cold air flow provides an even temperature throughout the entire cabinet.
- Intuitive control panel includes temperature set points, actual temperature indicator, clean condenser reminder and door open alarm.
- 270° door open.
- Space saving sliding door available for limited space applications.
- Air Curtain Ultra ships FOB and is exempt from any Cambro pre-paid freight programs.

Color: Stainless (000).

Capacity: 10/ea. 18" x 26" sheet pans or 20/ea. 13" x 18" sheet pans at 4.5" spacing.

Voltage/Phase: 120 / Single Phase.
Amps/Hertz: 6.5a / 60.

Plug Configuration: NEMA 5-15P.

*Dependent on ambient air temperature, and forced air near the unit.



Air Curtain Ultra is only available in North America.



Advanced digital controls.



Removable tray slides with tilt feature.

Recessed hand grips and rear mounted push bar.

1/2 HP Hi-Torque Condensing unit.

2 rigid and 2 swivel w/brake.

Optional, space-saving sliding door only requires 90° swing.



CODE	DESCRIPTION	DIMENSION W x D x H	UNIT WEIGHT	LIST PRICE EA.
ACU1826R	Right Door Swing	32" x 37½" x 78¾"	580 lbs.	\$ 17,150.00
ACU1826L	Left Door Swing	32" x 37½" x 78¾"	580	17,150.00
ACU1826RS	Right Sliding Door	32" x 37½" x 78¾"	580	18,800.00
ACU1826LS	Left Sliding Door	32" x 37½" x 78¾"	580	18,800.00

Case Pack: 1



MEAL DELIVERY CARTS FOR TRAY SERVICE

- Transport meal trays from the kitchen to acute care patients, nursing home residents or correctional facility inmates.
- Enhance patient satisfaction with high quality, room service style meals served quietly and efficiently.
- Tough, one-piece, double-wall polyethylene carts are easy to clean and won't rust, dent, crack, chip or break.
- Features light-weight non-insulated ABS doors.
- Features four total locking quiet, non-marking nylon casters (2 rigid, 2 swivel with brake). MDC1411T60 comes standard with plated casters.
- Features a latching mechanism to secure the doors closed during transport and a magnetic device to hold doors open 270° when loading or serving.

Single door 10-Tray Meal Delivery Cart is covered by U.S. Patent D 723,237 S.



10-TRAY DUAL ACCESS ROOM SERVICE CART – LOW PROFILE



Center opening provides self-venting airflow, optimizing food quality and humidity.

Large, molded-in ergonomic handle makes it easy to transport and maneuver.

Molded-in marine rail provides an additional tray landing surface. Marine rail is designed for use during service, not transport.

Polyurethane insulation ensures quiet meal delivery and provides structural strength.

Durable, lightweight, self-venting, ABS doors are non-insulated and open a full 270°, providing ergonomic access to trays from both the front and back of the cart.

Molded-in full-perimeter bottom bumper protects the cart, walls and furniture.



Menu clip holds routing directions or content lists.

Molded-in rails ensure quiet meal delivery, rail spacing 5¼" (13,34 cm).

Holds up to ten 15" x 20" (38 x 51 cm) trays.



Total locking quiet casters lock both swivel motion and wheel.



CODE	MDC1520S100
TRAY SIZE	15" x 20"
TRAYS PER COMPARTMENT/ RAIL SPACING	5 / 5¼"
EXTERNAL DIMENSIONS W x D x H	30¾" x 38¼" x 42¾"
INTERNAL DIMENSIONS W x D x H	21½" x 31" x 26¼"
CASTER TYPE	Nylon, 5" 2 rigid, 2 swivel with brake
UNIT WEIGHT	91 lbs.
LIST PRICE EACH	\$ 4,244.20

Case Pack: 1 Colors: Granite Gray (191), Granite Sand (194).

AIRPOT AND CONDIMENT STATION

- Holds three airpots for safe transport and service.
- Compartments are designed for stir sticks, napkins and a variety of condiments.
- Stain and odor resistant.
- Made of durable ABS material.
- Fits Cambro's 10-tray room service carts.

BSACS patent pending.



CODE	DIMENSIONS W x D x H	CASE PACK	LIST PRICE EA.
BSACS	23 $\frac{3}{4}$ " x 15 $\frac{3}{8}$ " x 6"	1	\$ 165.00

Color: Black (110). Airpots not included.



10-TRAY SINGLE DOOR ROOM SERVICE CART – LOW PROFILE



One louvered vent on the back supports air circulation to optimize food quality.

Large, molded-in ergonomic handle makes it easy to transport and maneuver.

Molded-in marine rail creates additional work surface during service. Marine rail is designed for use during service, not transport.



Molded-in rails ensure quiet meal delivery, rail spacing up to 5 $\frac{1}{4}$ " (13,34 cm).

Molded-in full-perimeter bottom bumper protects the cart, walls & furniture.

Lightweight, self-venting, ABS door is non-insulated and opens a full 270°.

Total locking quiet casters lock both swivel motion and wheel.



Menu clip holds routing directions or content lists.

CODE	MDC1520S10	MDC1520S10HD
TRAY SIZE	15" x 20"	15" x 20"
TRAYS PER RAIL / RAIL SPACING	2 / 5 $\frac{1}{4}$ "	2 / 5 $\frac{1}{4}$ "
EXTERNAL DIMENSIONS W x D x H	30 $\frac{3}{8}$ " x 38 $\frac{1}{4}$ " x 42 $\frac{3}{4}$ "	30 $\frac{3}{8}$ " x 38 $\frac{1}{2}$ " x 43 $\frac{1}{2}$ "
INTERNAL DIMENSIONS W x D x H	21 $\frac{1}{8}$ " x 31" x 26 $\frac{1}{4}$ "	21 $\frac{1}{8}$ " x 31" x 26 $\frac{1}{4}$ "
CASTER TYPE	Nylon, standard casters 5" x 1 $\frac{1}{4}$ "	Heavy Duty casters 6" x 2"
UNIT WEIGHT	78 lbs.	90 lbs.
LIST PRICE EACH	\$ 2,662.55	\$ 3,110.60

Case Pack: 1 Colors: Granite Gray (191) and Granite Sand (194).

20-TRAY MEAL DELIVERY CART – LOW PROFILE



MDC1520S20
Back view with louvered vents.

Marine rail is designed for use during service, not transport.



CODE	MDC1520S20	MDC1418S20
TRAY SIZE	15" x 20"	14" x 18"
TRAYS PER CART / PER COMPARTMENT	20 / 10	20 / 10
RAILS PER COMPARTMENT	5	5
TRAYS PER RAIL / RAIL SPACING	2 / 5½"	2 / 5½"
NUMBER OF COMPARTMENTS AND VENTS	2	2
NUMBER OF MENU CLIPS	2	2
MENU CLIPS - LOCATION	1 per door	1 per door
HANDLES - TYPE AND LOCATION	Molded in, each end	Molded in, each end
CASTER TYPE	Nylon, 6", 2 swivel w/brakes, 2 rigid, offset	Nylon, 5", 2 swivel w/brake, 2 rigid, offset
LATCHES	2 internal nylon friction	2 internal nylon friction
EXTERNAL DIMENSIONS W x L x H	38" x 55½" x 44¼"	32½" x 48½" x 44"
INTERNAL DIMENSIONS W x D x H	20½" x 30¼" x 27½"	18⅜" x 28⅝" x 29"
REQUIRED DOOR WIDTH	38½"	33"
UNIT WEIGHT	155 lbs.	141.5 lbs.
LIST PRICE EACH	\$ 4,001.55	\$ 3,934.60

Case Pack: 1 Colors (All carts with cream color doors): Slate Blue (401), Granite Gray (191), Granite Green (192), Granite Sand (194).

16 AND 30 TRAY MEAL DELIVERY CARTS – TALL PROFILE



Marine rail is designed for use during service, not transport.



Tall Profile

CODE	MDC1520T30	MDC1418T30	MDC1520T16	MDC1418T16
TRAY SIZE	15" x 20"	14" x 18"	15" x 20"	14" x 18"
TRAYS PER CART / COMPARTMENT	30 / 10	30 / 10	16 / 8	16 / 8
RAILS PER COMPARTMENT	10	10	4	4
TRAYS PER RAIL / RAIL SPACING	1 / 5"	1 / 5"	2 / 5¼"	2 / 5¼"
NUMBER OF COMPARTMENTS	3	3	2	2
NUMBER OF MENU CLIPS	5	5	1	1
MENU CLIPS - LOCATION	Each door, each end	Each door, each end	Back of cart only	Back of cart only
HANDLES - TYPE AND LOCATION	Heavy-duty nylon, mounted 1 per end	Heavy-duty nylon, mounted 1 per end	Molded-in, back of cart	Molded-in, back of cart
CASTER TYPE	Nylon, 6", 2 rigid, 4 swivel with brake, offset	Nylon, 6", 2 rigid, 4 swivel with brake, offset	Nylon, 6", 2 rigid, 2 swivel with brake	Nylon, 6", 2 rigid, 2 swivel with brake
LATCHES	Friction catch, transit latches*	Friction catch, transit latches*	Large paddle latch	Large paddle latch
EXTERNAL DIMENSIONS W x L x H	29¼" x 60" x 63⅝"	29¼" x 60" x 63⅝"	30⅞" x 39⅞" x 58⅞"	28" x 36½" x 58⅞"
INTERNAL DIMENSIONS W x D x H	15¼" x 21" x 50"	14½" x 21½" x 50"	20⅞" x 30½" x 21½"	18⅞" x 29⅞" x 21½"
REQUIRED DOOR WIDTH	30"	30"	31"	28½"
UNIT WEIGHT	210 lbs.	214 lbs.	137.5 lbs.	121 lbs.
LIST PRICE EACH	\$ 6,422.05	\$ 6,360.25	\$ 3,692.55	\$ 3,599.85

Case Pack: 1 Cart Colors (All carts with cream color doors): Slate Blue (401), Granite Gray (191), Granite Green (192), Granite Sand (194). *Stainless steel transit latch at top of each door. MDC1520T16 and MDC1418T16 are covered by U.S. Patent D 398,727. For lighter-duty applications, 30-tray carts may be ordered without the steel transit latches by using product code MDC1520T30NL or MDC1418T30NL.

60-TRAY MEAL DELIVERY CART FOR CORRECTIONAL TRAY SERVICE

- For use in correctional facilities.
- Holds 60 each 1411CW or 1411CP Cambro Base Trays with 853 Insert Trays or 60 each 10146DCW or 10146DCP Separator Compartment Trays.
- Security features include security screws on handles, stop locks on door knuckles, security bolts for transit latches and caster carriage bolts with lock nuts.



CODE	MDC1411T60
TRAY SIZE	14" x 11" base tray 1411CW and 1411CP
TRAYS PER CART / PER COMPARTMENT	60 / 20
RAILS PER COMPARTMENT	10
TRAYS PER RAIL / RAIL SPACING	2 / 5"
NUMBER OF COMPARTMENTS	3
HANDLES - TYPE AND LOCATION	Heavy-duty aluminum with security screws, black finish, 1 per end
CASTER TYPE	6" heavy-duty casters, 2" wide tread, 2 swivel with brake, 2 rigid
LATCHES	Internal friction catch, 2 per door, transit latch*
EXTERNAL DIMENSIONS W x L x H	29¼" x 60" x 63¾"
INTERNAL DIMENSIONS W x D x H	14½" x 21½" x 50"
REQUIRED DOOR WIDTH	30"
UNIT WEIGHT	216 lbs.
LIST PRICE EACH	\$ 6,360.25

Case Pack: 1 Colors: Granite Gray (191), Granite Sand (194), Slate Blue (401).
*Stainless steel transit latch at top of each door.

MEAL DELIVERY CARTS FEATURES AND CASTER CONFIGURATIONS

Standard Caster Configurations:

These caster configurations are designed to provide stability and maneuverability over uneven surfaces.

For optional caster configurations, contact your Cambro representative.

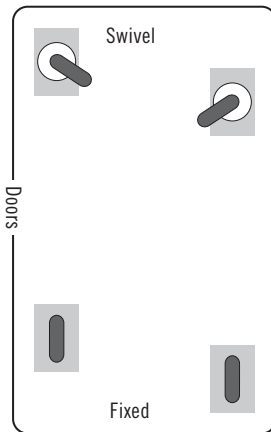

MDC1520S20, MDC1418S20, MDC1411T60

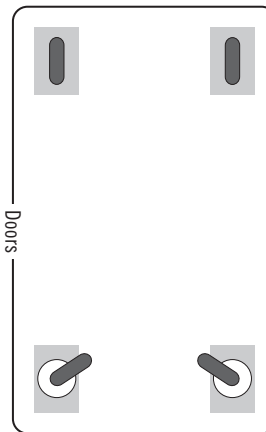

MDC1520S10, MDC1520S10D, MDC1520T16, MDC1418T16

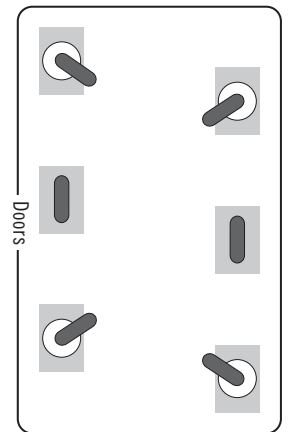

MDC1520T30, MDC1418T30

Handles

MDC1520S20, MDC1418S20



Molded in handles on each end for smooth transporting.

MDC1520T16, MDC1418T16



Molded in handles for easy transporting.

MDC1520T30, MDC1418T30, MDC1411T60**



Heavy duty nylon handles are securely mounted and nested into each end.
**MDC1411T60 has tamper resistant heavy duty aluminum tubing handles.

Lead in Casters



Castors are offset to ease movement over uneven surfaces. This is standard on MDC1520S10, MDC1520S10D, MDC1520S20, MDC1418S20, MDC1520T30, MDC1418T30 and MDC1411T60.

CAMSHELVING® HYGIENIC DRYING RACKS



- Keep tray line and warewashing areas organized and prevent wet stacking by storing newly washed products upright for faster drying before storing.
- Non-corrosive, break resistant and easy to assemble.
- Mobile racks allow for easy floor clean up and maneuverability.
- Drying cradles are removable and are high temperature dishwasher safe.
- Combine individual drying cradles to build custom drying racks on 24" deep Camshelving units.
- Lifetime warranty against rust and corrosion on posts and traverses.
- Drying Cradles are made of high impact ABS material.

***Camshelving Premium Series Color:** Speckled Gray (480).
****Drying Cradle Color:** Soft Gray (151).

Casters:
4 Premium Casters: (2 Swivel with Total Locking Brake, 2 Swivel with No Brake).



Vertical Drying Rack

- Securely holds various sizes of trays, cutting boards, baking sheet pans, lids and plates 8" to 13.5".
- Drying Cradles are installed directly onto shelf traverses.
- Fits 24" shelves.

7-Slot Drying Cradle is covered by U.S. Patent D 663,912 S.



CSDR7
 7-Slot Drying Cradle
 Width Per Slot: 1 5/16"



CODE	DESCRIPTION	DIMENSIONS D x L x H	HOLDING CAPACITY	CASE PACK	LIST PRICE EA.
Camshelving Premium*					
CPMU244875DRPKG	Vertical drying rack	24" x 48" x 75"	84 trays	1	\$ 1,454.15
CPMU246075DRPKG	Vertical drying rack	24" x 60" x 75"	105 trays	1	1,626.30
Drying Cradles**					
CSDR7	7-Slot drying cradle	23 1/2" x 10 1/4" x 3 3/4"		1	57.70
CSDR73	7-Slot drying cradle	23 1/2" x 10 1/4" x 3 3/4"		3	173.10 (Case price)

Drying Cradles fit on Camshelving Premium Series, mobile or stationary 24" deep shelves to 72" in length.
Package Includes: Pre-assembled mobile post kits, 6 traverses for each model, 12 or 15 drying cradles and premium swivel casters with total locking brake. Assembly required.



CPMU244875DRPKG
 Camshelving Premium

CAMSHELVING® HYGIENIC DRYING RACKS

Angled Drying Rack

- Securely holds up to 128 meal delivery Pellets/Bases or a variety of food pan sizes, pots and kitchen wares.
- Drying Cradles are installed directly onto shelf traverses.
- Fits 24" shelves.

*Camshelving Premium Series Color: Speckled Gray (480).

**Drying Cradle Color: Soft Gray (151).

8-Slot Drying Cradle is covered by U.S. Patent D739,989 S.



CSDR8
8-Slot Drying Cradle
Width Per Slot: 2 3/8"

CODE	DESCRIPTION	DIMENSIONS D x L x H	HOLDING CAPACITY	CASE PACK	LIST PRICE EA.
Camshelving Premium*					
CPMU244875PDPKG	Angled drying rack	24" x 48" x 75"	128 pellets and bases or 16 GN 1/1 food pans	1	\$ 1,531.30
Drying Cradles**					
CSDR8	8-Slot drying cradle	23 3/16" x 10 3/8" x 6 1/16"		1	46.35
CSDR84	8-Slot drying cradle	23 3/16" x 10 3/8" x 6 1/16"		4	185.40 (Case price)

Individual Drying Cradles fit on Camshelving Premium Series 24" deep shelves only, mobile or stationary.
Package Includes: Pre-assembled mobile post kits, 8 traverses, 16 drying cradles and premium swivel casters with total locking brake. Assembly required.



CPMU244875PDPKG
Camshelving Premium

Dome Drying Rack

- Securely holds 100 meal delivery domes.
- Drying Cradles are installed directly onto shelf traverses.
- Fits 24" shelves.

*Camshelving Premium Series Color: Speckled Gray (480).

**Drying Cradle Color: Soft Gray (151).

10-Slot Drying Cradle is covered by U.S. Patent D 736,488 S.



CSDDC
10-Slot Drying Cradle
Width Per Slot: 3 1/8"

CODE	DESCRIPTION	DIMENSIONS D x L x H	HOLDING CAPACITY	CASE PACK	LIST PRICE EA.
Camshelving Premium*					
CPMU243675DDPKG	Dome drying rack	24" x 36" x 75"	100 domes	1	\$ 1,490.00
Drying Cradles**					
CSDDC24	10-slot drying cradle	23 1/2" x 16 1/3" x 3 3/8"		1	67.00
CSDDC245	10-slot drying cradle	23 1/2" x 16 1/3" x 3 3/8"		5	335.00 (Case price)

Individual Drying Cradles fit on Camshelving Premium 24" deep shelves only, mobile or stationary.
Package Includes: Pre-assembled mobile post kits, 10 traverses, 10 drying cradles and premium swivel casters with total locking brake. Assembly required.



CPMU243675DDPKG
Camshelving Premium

ALPHA NUMERICAL LISTING

Discontinued items effective 1/1/2020

CODE	PAGE	PRICE	CODE	PAGE	PRICE	CODE	PAGE	PRICE
1000	205	13.60	10HS434	73	60.40	12HP	162	64.10
1000 (Group 3)	205	17.65	10HS638	73	72.90	12HP772	Discontinued	
1000CW	185	11.65	10HS800	73	88.20	12HPH	165	73.70
1000LCD	42	438.60	10HS958	73	103.65	12PP	167	13.70
1000LCDCVR	42	130.00	10PPCH	168	12.80	12RS12	57	209.10
1005CW	185	11.90	10PPCWSC	159, 168	12.30	12SFSCW	144	26.45
1007CW	185	11.90	10PPD	167	9.85	12SFSCW441	174	29.10
100BC	Discontinued		1100	205	13.60	12SFSP	146	19.45
100BC1	Discontinued		1100 (Group 3)	205	17.20	12SFSP	146	20.40
100BCS	Discontinued		1100CT	213	19.70	12TGS	197	6.10
100CW	184	2.80	1101CW	185	11.90	1300	205	16.55
100LCD	42, 44	239.70	1116	205	17.30	1300 (Group 3)	205	21.85
100MCCW	173	13.70	1116 (Group 3)	205	24.25	1313	206	16.55
100MCCW441	174	15.05	1120CBP	92	18.60	1313 (Group 3)	206	21.70
100MPC	35	438.60	1120CBR	92	24.75	1318	204	22.95
100MPCHL	34	550.80	116VS	185	16.05	1318 (Group 3)	204	28.65
100VS	185	13.65	1200	205	15.00	1318CC	29	540.60
1010VS	185	14.90	1200 (Group 3)	205	20.10	1318MT	217	21.50
1012VS	185	14.90	1200CW	181	2.50	13CLRCW	160	27.15
1013CW	185	11.95	1200DIV	38, 55	91.65	13CLRHP	164	77.55
1014	204	16.00	1200P	180	1.65	1400	205	16.85
1014 (Group 3)	204	20.70	1200P2	180	1.75	1400 (Group 3)	205	22.85
10145CW	220	14.95	1202CW	185	11.95	1400CT	213	26.20
10146CW	218, 220	13.70	120CWP	184	8.40	1400ET	Discontinued	
10146DCP	221	9.25	120VS	185	20.60	1400TL	214	15.75
10146DCPC	221	5.40	1210PW	38	200.15	14105CP	220	7.10
10146DCW	221	17.60	1216	204	18.50	14105CW	220	15.00
10146DCWC	221	9.35	1216 (Group 3)	204	24.25	1411CP	222	6.55
1014CL	217	15.30	1216CL	217	17.30	1411CW	222	17.50
1014CT	213	24.25	1216CT	213	28.05	1418	204, 174	22.10
1014FF	216	4.85	1216D	206	19.10	1418 (Group 3)	204	28.80
1014VS	185	14.90	1216D (Group 3)	206	25.35	14187TRCW	220	26.90
1015	205	16.55	1216DC	209	24.25	1418CL	217	19.75
1015 (Group 3)	205	21.40	1216DCET	209, 225	30.31	1418CT	213	34.90
1015MT	217	16.80	1216FF	216	5.80	1418CW	211	24.95
10302MT	217	39.15	12183CW	152	24.10	1418CWH	211, 225	34.55
1030MT	217	26.50	12183P	154	19.95	1418CWNS	211, 225	39.25
103VS	185	14.05	12186CW	152	30.50	1418CWNSH	211, 225	40.60
105VS	185	14.05	12186P	154	24.85	1418D	206	22.25
106VS	185	15.75	12189CW	56, 152	41.00	1418D (Group 3)	206	29.40
10CW	184	3.25	12189P	154	32.85	1418DC	209	28.80
10CWC	159	18.00	1218CCW	152	14.90	1418DCET	209, 225	39.25
10CWCH	159	18.00	1218CP	154	15.30	1418FF	216	7.45
10CWCHN	159	18.00	1218DSCW	153	9.70	1418H	206	25.00
10CWD	158	15.50	1218MT	217	20.90	1418TR	204	20.95
10CWGL	159	37.95	1218SCCW	56, 152	31.80	1418TR (Group 3)	204	28.30
10CWL	184	2.50	1219D	206	22.45	1418TRCW	211	24.95
10CWNR	184	6.90	1219D (Group 3)	206	29.00	1418VC	210, 224	39.25
10HC258	74, 78	29.70	1220D	206	24.30	1418VCH	210, 224	40.60
10HC414	74	49.35	1220D (Group 3)	206	31.20	1422TR	204	22.95
10HE1	79	15.70	1222D	206	24.30	1422TR (Group 3)	204	31.05
10HE2	79	14.75	1222D (Group 3)	206	31.15	14CW	158	27.15
10HPC	163	57.55	1224MT	217	26.20	14HP	162	77.55
10HPCH	163	57.55	1230MT	217	30.45	14HP772	Discontinued	
10HPCHN	163	57.60	124VS	185	21.35	14PP	167	17.30
10HPD	162	42.45	1252SLB250	155	350.20	150CW	184	4.45
10HS1114	73	118.90	1252SLINB250	155	350.20	1520	204	26.70
10HS318	73	44.20	12CW	158	21.35	1520 (Group 3)	204	34.65

ALPHA NUMERICAL LISTING

Discontinued items effective 1/1/2020

CODE	PAGE	PRICE
1520CBCP	92	15.55
1520CBP	92	19.15
1520CBPF	92	19.15
1520CBR	92	25.35
1520CL	217	22.55
1520CT	213	39.70
1520CW	211	25.95
1520CWH	211, 225	38.65
1520CWNS	211, 225	43.90
1520CWNSH	211, 225	46.20
1520D	206	26.45
1520D (Group 3)	206	33.45
1520DC	209	34.65
1520DCET	209, 225	43.90
1520H	206	29.75
1520TR	204	24.45
1520TR (Group 3)	204	31.95
1520VC	210, 224	43.90
1520VCRST	210, 224	46.20
1525RST	212	32.40
1550	205	21.55
1550 (Group 3)	205	28.10
1550CT	213	35.60
1596CP	219	7.00
1596CW	219	12.05
15CLRCW	160	32.95
15CLRHP	164	100.80
1600	205	21.15
1600 (Group 3)	205	28.30
1600CT	213	34.55
1600CW	181	3.10
1600DIV	38, 52	91.65
1600ET	Discontinued	
1600P	180	1.95
1600P2	180	2.05
1600TL	214	21.00
1621CBP	92	29.00
1622	204	30.75
1622 (Group 3)	204	40.00
16225	204	33.70
16225 (Group 3)	204	42.10
1622CT	213	49.00
16C258	74, 78	41.65
16C414	74	58.05
16C578	74	86.80
16CW	56, 158	32.95
16E1	78	18.70
16E2	78	16.60
16E4	79	20.05
16E5	79	17.65
16HP	162	100.80
16HP772	Discontinued	
16PP	167	22.15
16S1058	69	130.60
16S1114	69	149.75
16S1214	69	151.55
16S318	69	58.60
16S418	69	61.40

CODE	PAGE	PRICE
16S434	69	76.80
16S534	69	78.65
16S638	69	92.20
16S738	69	94.10
16S800	69	111.30
16S900	69	113.30
16S958	69	128.60
1722CBCP	92	28.00
1722CBP	92	23.30
1722CBR	92	32.90
17HE1	79	16.35
17HE2	79	15.70
17HS1114	73	128.60
17HS318	73	46.05
17HS434	73	62.90
17HS638	73	79.30
17HS800	73	96.10
17HS958	73	112.60
1800CT	213	49.00
1826	204	41.00
1826 (Group 3)	204	52.75
182612CW	152	91.35
182612P	154	68.50
182615CW	152	107.80
182615P	154	80.60
18263CW	152	44.00
18263P	154	33.00
18266CW	152	57.00
18266P	154	43.30
18268CLRCW	153	81.55
18268CLRKIT	153	209.95
18269CW	152	75.00
18269P	154	56.50
1826CCW	152	29.85
1826CL	217	32.45
1826CLRCW	153	47.15
1826CP	154	25.45
1826CT	213	58.80
1826DBC	28	2,611.05
1826DBCSP	28	3,301.15
1826DSCW	153	24.55
1826DTC	28	2,611.05
1826DTCSP	28	3,321.75
1826HAR	29, 37	92.70
1826LBC	29	1,565.60
1826LBCSP	29	1,946.70
1826LTC	29	1,581.05
1826LTC3	29	1,581.05
1826LTCSP	29	1,977.60
1826MT	199, 217	34.25
1826MTC	29	810.90
1826SCCW	152	53.45
18CW	158	39.35
18PP	167	29.75
18SFSCW	144	39.25
18SFSCW441	174	43.20
18SFSP	146	26.30
18SFSP	146	27.75

CODE	PAGE	PRICE
1950	205	29.20
1950 (Group 3)	205	38.50
1950CT	213	50.15
2000P	180	2.40
2000P2	180	2.60
200BC	Discontinued	
200BC1	Discontinued	
200BCS	Discontinued	
200MCCW	173	18.90
200MCCW441	174	20.80
200MCH	173	50.00
2025	204	50.00
2025 (Group 3)	204	60.85
2025MT	217	44.80
2030UT	83	772.50
20C258	74, 78	43.20
20C414	74	59.45
20CC	180	2.80
20CFC	169	15.60
20CWC	159	9.40
20CWCH	159	9.40
20CWCHN	159	11.00
20CWD	158	7.20
20CWGL	159	26.35
20CWL	159	14.85
20CWLN	159	14.85
20E2	78	15.35
20GE1	78	19.70
20GE2	78	17.10
20HPC	163	25.05
20HPCH	163	26.55
20HPCHN	163	30.45
20HPD	162	19.05
20HPL	163	44.10
20HPLN	163	44.10
20LPCWC	159	13.80
20LPCWD	158	8.05
20LPHPC	163	34.35
20LPHPD	162	21.20
20PPCH	168	8.80
20PPCWSC	159, 168	7.50
20PPD	167	5.10
20S1114	70	149.75
20S318	70	58.60
20S434	70	77.75
20S638	70	93.00
20S800	70	111.30
20S958	70	128.60
21155CBP	92	21.60
21155CBR	92	29.70
21157CBP	92	23.30
21157CBR	92	34.25
2115CBCP	92	15.50
2115CBCR	92	15.45
22CW	158	11.85
22HP	162	31.95
22HP772	Discontinued	
22LPCW	158	16.20

ALPHA NUMERICAL LISTING

Discontinued items effective 1/1/2020

CODE	PAGE	PRICE	CODE	PAGE	PRICE	CODE	PAGE	PRICE
22LPHP	162	45.60	2SFSCW	144	8.55	36E5	79	20.05
22PP	167	8.40	2SFSCW441	174	9.40	36HP	162	47.15
22SFSCW	144	49.75	2SFSP	146	6.80	36HP772	Discontinued	
22SFSCW441	174	54.75	2SFSP	146	7.15	36PP	167	9.90
22SFSP	146	32.15	300DIV	38	80.35	36S1058	71	144.90
22SFSP	146	34.20	30CFC	169	13.05	36S1114	71	149.75
23CLRCW	160	14.75	30CWC	159	6.90	36S1214	71	164.25
23CLRHP	164	41.55	30CWCH	159	6.90	36S318	71	61.40
23SL	155	381.10	30CWCHN	159	9.40	36S418	71	66.20
23SLB250	155	705.55	30CWD	158	6.65	36S434	71	78.65
23SLB6250	155	183.35	30CWGL	159	18.15	36S534	71	85.40
23SLINB250	155	705.55	30CWL	159	12.70	36S638	71	94.85
240MPC	34	306.00	30CWLN	159	12.70	36S738	71	105.45
2436UTH	83	726.15	30GE1	78	20.05	36S800	71	113.30
2436UTHS	83	772.50	30GE2	78	18.05	36S900	71	125.75
24CW	158	14.75	30HPC	163	18.70	36S958	71	132.45
24HP	162	41.55	30HPCH	163	21.10	38CW	158	18.30
24HP772	Discontinued		30HPCHN	163	21.10	38PP	167	12.80
24LPCW	56, 158	20.20	30HPD	162	14.30	400DIV	38	80.35
24LPHP	162	56.70	30HPL	163	31.50	400MCCW	173	20.50
24PP	167	10.35	30HPLN	163	31.50	400MCCW441	174	22.85
2500	205	39.95	30PPCH	168	6.10	400MCH	173	75.00
2500 (Group 3)	205	52.75	30PPCHN	168	7.50	400STP	25, 32, 33, 37	15.45
2500CT	213	62.35	30PPCWSC	159, 168	5.65	40CWC	159	6.25
250LCD	42	249.90	30PPD	167	4.75	40CWCH	159	6.25
250LCDCVR	42	130.00	30S1114	70	149.75	40CWCHN	159	6.25
25CLRCW	160	18.95	30S318	70	61.40	40CWD	158	5.55
25CLRHP	164	53.25	30S434	70	78.65	40HPC	163	15.20
25E1	78	19.70	30S638	70	94.85	40HPCH	163	16.35
25E2	78	17.10	30S800	70	113.30	40HPCHN	163	16.55
25E4	79	22.90	30S958	70	132.45	40HPD	162	14.30
25E5	79	19.20	3200P2	180	3.90	40PPCH	168	5.90
25MCCW	173	6.55	3253CL	217	19.50	40PPCWSC	159, 168	5.00
25MCCW441	174	7.20	3253CT	213	40.85	40PPD	167	3.95
25S1058	70	140.10	32CC	180	4.25	415CBP	92	8.55
25S1114	70	149.75	32CW	158	8.90	42CW	158	9.00
25S1214	70	161.15	32HP	162	26.75	42HP	162	23.15
25S318	70	58.60	32HP1H	165	41.00	42HP772	Discontinued	
25S418	70	63.40	32HP2H	165	42.00	42PP	167	6.30
25S434	70	77.75	32HP772	Discontinued		44CW	158	10.60
25S534	70	81.60	32PP	167	6.30	44HP	162	28.60
25S638	70	93.00	33CLRCW	160	12.25	44HP772	Discontinued	
25S738	70	100.65	33CLRHP	164	34.65	44PP	167	7.40
25S800	70	111.30	33CLRPP	166	8.55	45CW	184	2.75
25S900	70	120.90	34CW	158	12.25	46	204	5.10
25S958	70	128.60	34HP	162	34.65	46 (Group 3)	204	7.10
25SWGf	75, 180	90.90	34HP772	Discontinued		46CW	158	12.25
26CF	169	61.65	34PP	167	8.55	46HP	162	36.65
26CW	158	18.95	350LCD	42	244.80	46HP772	Discontinued	
26HP	162	53.25	35CLRCW	160	14.30	46PP	167	8.55
26HP772	Discontinued		35CLRHP	164	47.15	49E1	78	20.05
26PP	167	13.45	35CLRPP	166	9.90	49E2	79	18.05
2700	205	46.55	35CW	184	2.25	49S1114	71	155.50
2700 (Group 3)	205	61.65	36CF	169	46.35	49S318	71	62.35
2700CT	213	70.20	36CW	158	14.30	49S434	71	80.55
28CW	158	24.10	36E1	78	20.05	49S638	71	96.90
28PP	167	17.70	36E2	79	18.05	49S800	71	113.30
2900CT	213	79.65	36E4	79	25.90	49S958	71	134.35

ALPHA NUMERICAL LISTING

Discontinued items effective 1/1/2020

CODE	PAGE	PRICE
4FBRTT	50	1,545.00
4SFSCW	144	13.05
4SFSCW441	174	14.35
4SFSP	146	9.25
4SFSPPP	146	9.85
500CW	181	1.55
500LCD	42	285.60
500LDCVCR	42	130.00
500P	180, 230	1.05
500P2	180, 230	1.10
50CW	184	3.25
50MCCW	173	12.20
50MCCW441	174	13.40
5412CBP	44, 57	10.25
55CWNR	184	2.75
57	204	5.50
57 (Group 3)	204	7.70
5FBRTT	50	1,704.65
60CFC	169	6.95
60CW	184	3.25
60CWC	159	4.90
60CWCH	159	5.40
60CWCHN	159	5.40
60CWD	158	2.95
60CWGL	159	14.90
60CWL	159	7.20
60CWLN	159	7.20
60HPC	163	13.25
60HPCH	163	13.25
60HPCHN	163	13.25
60HPD	162	7.35
60HPL	163	18.05
60HPLN	163	18.05
60PPCH	168	5.15
60PPCHN	168	5.60
60PPCWSC	159, 168	3.85
60PPD	167	2.65
62CW	158	6.55
62HP	162	18.10
62HP772	Discontinued	
62PP	167	4.85
6302MT	217	33.25
630MT	217	21.20
63CLRCW	160	7.40
63CLRHP	164	21.85
63CLRPP	166	5.50
64CW	158	7.40
64HP	162	21.85
64HP772	Discontinued	
64PP	167	5.50
650WS	60	68.00
65CLRCW	160	9.90
65CLRHP	164	26.50
65CLRPP	166	6.25
65CWNR	184	3.25
66CF	169	31.55
66CW	158	9.90
66HP	162	26.50

CODE	PAGE	PRICE
66HP772	Discontinued	
66PP	167	7.20
68VS	185	11.35
6F	194	12.25
6FBRTT	50	1,838.55
6RS6	57	151.40
6SFSCW	144	16.90
6SFSCW441	174	18.60
6SFSP	146	11.55
6SFSPPP	146	12.20
6TGS	197	2.60
725CWNR	184	4.45
730SR	60	108.15
730STP	55	26.80
730WS	60	47.40
75CW	184	4.25
800CW	181	1.90
800P	180, 230	1.25
800P2	180, 230	1.35
806CW	185	9.75
80CWC	159	5.20
80CWCH	159	5.70
80CWCHN	159	5.70
80CWD	158	2.60
80HPC	163	11.15
80HPCH	163	11.15
80HPCHN	163	11.15
80HPD	162	6.45
80PPCWSC	159	3.70
810	204	12.15
810 (Group 3)	204	15.70
825CWNR	184	5.20
8262MT	217	27.25
826MT	217	17.35
82CW	158	6.60
82HP	162	15.85
82HP772	Discontinued	
8302MT	217	36.60
830MT	217	23.95
84CW	158	7.75
84HP	162	20.05
84HP772	Discontinued	
850CW	181	4.85
853FCP	222	5.80
853FCPC	222	3.10
853FCW	222	11.35
853FCWC	222	6.00
853FH	222	23.55
853FHC	222	13.55
85SFVS	185	13.40
86CW	158	10.25
86HP	162	25.85
86HP772	Discontinued	
86VS	185	12.55
8F	194	14.25
8FB434	77	49.00
8FBNH434	77	28.75
8HC258	74, 78	29.70

CODE	PAGE	PRICE
8HC414	74	49.35
8HE1	79	15.70
8HE2	79	14.10
8HS1114	73	118.90
8HS318	73	44.20
8HS434	73	60.40
8HS638	73	72.90
8HS800	73	88.20
8HS958	73	103.65
8RS8	57	168.90
8SFSCW	144	19.85
8SFSCW441	174	21.85
8SFSP	146	13.65
8SFSPPP	146	14.45
900	205	12.30
900 (Group 3)	205	15.60
900CT	213	19.70
900CW	185	9.85
900P	180, 230	2.15
900P2	180, 230	2.35
9011CW	185	11.70
9013CW	185	11.70
901CW	185	10.50
905CW	185	10.80
909CW	185, 229	10.75
90CWC	159	5.50
90CWCN	159	5.50
90CWD	158	2.25
90HPC	163	9.10
90HPD	162	5.45
90PPC	168	4.45
90PPCWSC	159, 168	3.45
90PPD	167	1.80
90SPCW	184	7.35
9113CP	221	7.25
9113CW	221	16.05
9114CP	221	7.25
9114CW	221	16.75
911CPC	221	3.95
911CWC	221	11.35
911VS	185	13.80
912CBP	92	11.65
913MT	217	18.55
913VS	185	13.40
915	204	17.25
915 (Group 3)	204	20.00
915CP	219	7.00
915CW	219	12.05
918MT	217	20.15
91VS	185	13.40
926	204	22.55
926 (Group 3)	204	29.20
92615MT	217	22.35
926MT	217	22.40
92CW	158	6.65
92HP	162	13.70
92HP772	Discontinued	
92PP	167	5.10

ALPHA NUMERICAL LISTING

Discontinued items effective 1/1/2020

CODE	PAGE	PRICE	CODE	PAGE	PRICE	CODE	PAGE	PRICE
93CW	184	7.30	BAR730CP	63	8,852.85	CBA185472V4	124	419.70
94CW	158	8.10	BAR730DS	63	8,337.85	CBA185484V5	125	518.00
94HP	162	16.00	BAR730DSCP	63	12,493.90	CBA186064V4	124	449.55
94HP772	Discontinued		BAR730DSDX	62	13,704.15	CBA186072V4	124	451.10
94PP	167	6.25	BAR730DSPM	62	17,345.20	CBA186084V5	125	557.25
950CW	181	2.20	BAR730DSPMT	62	19,528.80	CBA213064V4	124	302.10
950P	180, 230	1.45	BAR730DSPMT2	62	19,652.40	CBA213072V4	124	303.60
950P2	180, 230	1.60	BAR730DX	62	10,248.50	CBA213084V5	125	372.40
95VS	185	13.40	BAR730PM	62	15,367.60	CBA213664V4	124	341.70
96CW	184	4.25	BAR730PMT	62	16,799.30	CBA213672V4	124	343.20
96PCW	158	10.15	BAR730PMT220	62	16,922.90	CBA213684V5	125	421.90
96PHP	162	22.75	BBR480	50	860.05	CBA214264V4	124	394.30
96SKRC	198	5.85	BBR720	50	1,019.70	CBA214272V4	124	395.80
96SKRD	198	5.85	BC1115SH	91	82.40	CBA214284V5	125	487.65
96SKRLC	198	1.05	BC11TC	91	92.70	CBA214864V4	124	414.10
96SKRLD	198	1.05	BC225	91	623.15	CBA214872V4	124	415.60
96SKRLM	198	1.05	BC2254S	91	643.75	CBA214884V5	125	512.40
96SKRLP	198	1.00	BC230	91	787.95	CBA215464V4	124	467.10
96SKRM	198	5.85	BC2304S	91	808.55	CBA215472V4	124	468.60
96SKRP	198	5.85	BC235	91	854.90	CBA215484V5	125	578.65
978SFVS	185	13.65	BC2354S	91	875.50	CBA216064V4	124	502.90
99VS	185	13.40	BC330	91	849.75	CBA216072V4	124	504.40
9CWNR	184	5.00	BC3304S	91	870.35	CBA216084V5	125	623.40
9E1	78	17.60	BC331KD	89	216.00	CBA243064V4	124	317.90
9E2	78	16.60	BC331KDSH	89	50.60	CBA243072V4	124	319.45
9RS9	57	184.35	BC331KDTC	89	88.00	CBA243084V5	125	392.00
9S1114	69	149.75	BC340KD	89	321.00	CBA243664V4	124	352.50
9S318	69	58.60	BC340KDP	89	88.00	CBA243672V4	124	354.05
9S434	69	76.45	BCT1014	218	10.65	CBA243684V5	125	435.25
9S638	69	91.20	BR258	76, 78	38.25	CBA244264V4	124	399.30
9S800	69	110.95	BR414	76	55.70	CBA244272V4	124	400.85
9S958	69	128.60	BR578	76, 233	71.40	CBA244284V5	125	493.75
9TGS	197	4.00	BR712	76	87.65	CBA244864V4	124	430.10
ACU1826L	234	17,150.00	BSACS	236	165.00	CBA244872V4	124	431.65
ACU1826LS	234	18,800.00	BSB10	194	12.30	CBA244884V5	125	532.25
ACU1826R	234	17,150.00	BSB12	194	15.85	CBA245464V4	124	474.10
ACU1826RS	234	18,800.00	BSB18	194	33.40	CBA245472V4	124	475.65
ADCS	85	1,369.90	BUF48	50	453.20	CBA245484V5	125	587.25
ADCSC	87	1,150.00	BUF72	50	525.30	CBA246064V4	124	506.50
ADCSC12PKG	87	1,740.00	BV6CW	187	3.50	CBA246072V4	124	508.05
ADCSC8PKG	87	1,445.00	BWB16CW	176	12.15	CBA246084V5	125	627.75
ADCSC4	86	295.00	BWM10CW	176	11.65	CBCC1	126	5.65
BAR540	65	2,714.05	BWP14CW	176	12.65	CBCC10	126	56.50
BAR540DS	65	3,445.35	BWW10CW	176	9.20	CBCC8	126	45.20
BAR54SR	60	74.15	CB1220	22, 52, 53, 55	43.25	CBDS18H10	126	51.95
BAR650	65	5,294.20	CBA183064V4	124	274.95	CBDS18H6	126	51.75
BAR650CP	65	7,797.10	CBA183072V4	124	276.50	CBDS21H10	126	53.35
BAR650DS	65	7,143.05	CBA183084V5	125	339.00	CBDS21H6	126	53.15
BAR650DSCP	65	10,063.10	CBA183664V4	124	308.75	CBDS24H10	126	54.60
BAR650DSDX	64	11,577.20	CBA183672V4	124	310.30	CBDS24H6	126	54.40
BAR650DSPM	64	15,764.15	CBA183684V5	125	381.25	CBID6	127	2.90
BAR650DSPMT	64	17,767.50	CBA184264V4	124	355.35	CBR18E	128	24.20
BAR650DSPMT2	64	17,885.95	CBA184272V4	124	356.90	CBR21E	128	25.55
BAR650DX	64	9,584.15	CBA184284V5	125	439.50	CBR2436	128	125.05
BAR650PM	64	14,291.25	CBA184864V4	124	371.95	CBR24363	128	89.50
BAR650PMT	64	15,661.15	CBA184872V4	124	373.50	CBR2442	128	133.20
BAR650PMT220	64	16,129.80	CBA184884V5	125	460.25	CBR24423	128	93.60
BAR730	63	6,200.60	CBA185464V4	124	418.15	CBR2448	128	139.25

ALPHA NUMERICAL LISTING

Discontinued items effective 1/1/2020

CODE	PAGE	PRICE	CODE	PAGE	PRICE	CODE	PAGE	PRICE
CBR24483	128	96.60	CBU243084V5	125	476.25	CECDC6	81	1.90
CBR24E	128	27.00	CBU243664V4	124	424.20	CECFL6	81	1.90
CBR30S	128	32.50	CBU243672V4	124	427.30	CECGO6	81	1.90
CBR36S	128	35.55	CBU243684V5	125	519.50	CECGR6	81	1.90
CBR42S	128	39.60	CBU244264V4	124	471.00	CECHB6	81	1.90
CBR48S	128	42.65	CBU244272V4	124	474.10	CECHU6	81	1.90
CBR54S	128	46.65	CBU244284V5	125	578.00	CECIC6	81	1.90
CBR60S	128	49.65	CBU244864V4	124	501.80	CECIT6	81	1.90
CBTR30	126	27.80	CBU244872V4	124	504.90	CECJU6	81	1.90
CBTR302PK	126	50.50	CBU244884V5	125	616.50	CECMG6	81	1.90
CBTR36	126	28.00	CBU245464V4	124	545.80	CECMT6	81	1.90
CBTR362PK	126	50.90	CBU245472V4	124	548.90	CECOF6	81	1.90
CBTR42	126	31.10	CBU245484V5	125	671.50	CECPI6	81	1.90
CBTR422PK	126	56.40	CBU246064V4	124	578.20	CECPO6	81	1.90
CBTR48	126	34.00	CBU246072V4	124	581.30	CECRF6	81	1.90
CBTR482PK	126	61.80	CBU246084V5	125	712.00	CECRT6	81	1.90
CBTR54	126	37.10	CBUPR1826S6	129	180.00	CECRW6	81	1.90
CBTR542PK	126	67.30	CC32	172	638.60	CECSB6	81	1.90
CBTR60	126	39.90	CCP12	195	10.15	CECSG6	81	1.90
CBTR602PK	126	72.50	CCP15	195	15.85	CECSH6	81	1.90
CBU183064V4	124	344.30	CCP27	195	16.90	CECWF6	81	1.90
CBU183072V4	124	347.40	CCPL12	195	1.45	CECW16	81	1.90
CBU183084V5	125	421.00	CCPL27	195	1.50	CECWT6	81	1.90
CBU183664V4	124	378.10	CD100	37	334.75	CECWW6	81	1.90
CBU183672V4	124	381.20	CD100H	36	535.60	CFPFRC10	169	38.65
CBU183684V5	125	463.25	CD100HB	36	648.90	CFPMRC10	169	39.00
CBU184264V4	124	424.70	CD1313	83	283.25	CFPSRC10	169	16.40
CBU184272V4	124	427.80	CD1327	83	303.85	CFR18	169	34.25
CBU184284V5	125	521.50	CD1420	37, 83	303.85	CFRC18	169	19.05
CBU184864V4	124	441.30	CD160	37	334.75	CFRSC18	169	5.65
CBU184872V4	124	444.40	CD1826H	36, 82	566.50	CHPL100	233	8,925.00
CBU184884V5	125	542.25	CD1826HB	36, 82	700.40	CJ80CW	198	8.25
CBU185464V4	124	487.50	CD1826MTC	36	618.00	CL800P	180, 230	76.55
CBU185472V4	124	490.60	CD1826MTCB	36	777.65	CL900P	177, 180, 181, 230	97.75
CBU185484V5	125	600.00	CD1826PDB	170	375.95	CL950P	180, 230	71.30
CBU186064V4	124	518.90	CD2020	37, 82	309.00	CLAM8B5	178, 179	99.10
CBU186072V4	124	522.00	CD2020H	36, 82	484.10	CLJ6	177, 180, 230	66.60
CBU186084V5	125	639.25	CD2020HB	36, 82	623.15	CLLT10	179, 230	89.25
CBU213064V4	124	373.20	CD2028	37, 83	319.30	CLLT12	179, 230	97.75
CBU213072V4	124	376.20	CD300	30, 37	334.75	CLLT6	179, 230	110.25
CBU213084V5	125	456.05	CD300H	30, 36	525.30	CLLT8	179	141.75
CBU213664V4	124	412.80	CD300HB	36	623.15	CLNT10	177, 178, 181, 230	89.25
CBU213672V4	124	415.80	CD400	25, 32, 33, 37	370.80	CLNT12	177, 178, 230	97.75
CBU213684V5	125	505.55	CDC300	14, 37	185.00	CLNT5	178, 230	110.25
CBU214264V4	124	465.40	CDC400	14, 37	210.00	CLNT8	178, 230	69.60
CBU214272V4	124	468.40	CDR2020	75, 82	180.25	CLNT9	178, 230	97.75
CBU214284V5	125	571.30	CDR2020H	75, 82	288.40	CLRSB16	233	267.80
CBU214864V4	124	485.20	CECBE6	81	1.90	CLRSB9	233	163.25
CBU214872V4	124	488.20	CECBL6	81	1.65	CLRSM8B5	233	122.55
CBU214884V5	125	596.05	CECBM6	81	1.90	CLRWSR36	233	25.65
CBU215464V4	124	538.20	CECBR6	81	1.90	CLS89	227	81.90
CBU215472V4	124	541.20	CECCF6	81	1.90	CLSM8B5	177, 178, 227	97.65
CBU215484V5	125	662.30	CECCH6	81	1.90	CLSRB5	186	146.45
CBU216064V4	124	574.00	CECCL6	81	1.90	CLSSM8B5	227	81.90
CBU216072V4	124	577.00	CECCM6	81	1.90	CLST6	177, 230	69.60
CBU216084V5	125	707.05	CECCO6	81	1.90	CLST9	177, 179	97.75
CBU243064V4	124	389.60	CECCP6	81	1.90	CMBH1826LC	22	6,452.95
CBU243072V4	124	392.70	CECCR6	81	1.90	CMBH1826LF	22	6,452.95

ALPHA NUMERICAL LISTING

Discontinued items effective 1/1/2020

CODE	PAGE	PRICE	CODE	PAGE	PRICE	CODE	PAGE	PRICE
CMBH1826LSP	22	6,756.80	CPA214284V5PKG	107	791.35	CPHU214275S4	110	1,108.30
CMBH1826TBC	22	10,078.55	CPA214864V4	106	672.40	CPHU214275V4	110	1,082.90
CMBH1826TBF	22	10,078.55	CPA214872V4	106	674.75	CPHU214867S4	110	1,144.50
CMBH1826TSC	22	10,078.55	CPA214884V5PKG	107	831.60	CPHU214867V4	110	1,109.90
CMBH1826TSF	22	10,078.55	CPA215464V4	106	757.20	CPHU214875S4	110	1,149.70
CMBH1826TSP	22	10,634.75	CPA215472V4	106	759.55	CPHU214875V4	110	1,115.10
CMBHC1826LC	22	15,207.95	CPA215484V5PKG	107	937.60	CPHU215467S4	110	1,230.70
CMBHC1826LF	22	15,207.95	CPA216064V4	106	815.40	CPHU215467V4	110	1,194.70
CMBHC1826LSP	22	15,558.15	CPA216072V4	106	817.75	CPHU215475S4	110	1,235.90
CMBHC1826TBC	22	21,362.20	CPA216084V5PKG	107	1,010.35	CPHU215475V4	110	1,199.90
CMBHC1826TBF	22	21,362.20	CPA217264V4PKG	106	931.20	CPHU216067S4	110	1,290.70
CMBHC1826TSC	22	21,362.20	CPA217272V4PKG	106	933.55	CPHU216067V4	110	1,252.90
CMBHC1826TSF	22	21,362.20	CPA217284V5PKG	107	1,155.10	CPHU216075S4	110	1,295.90
CMBHC1826TSP	22	21,954.45	CPA242464V4	106	442.60	CPHU216075V4	110	1,258.10
CMBR	22	56.65	CPA242472V4	106	445.30	CPHU243667S4	110	1,043.50
CP12	195	8.85	CPA242484V5PKG	107	544.45	CPHU243667V4	110	1,010.70
CP1210	38, 52, 55	75.20	CPA243064V4	106	521.80	CPHU243675S4	110	1,048.80
CP1220	38, 44, 52, 55	144.20	CPA243072V4	106	524.50	CPHU243675V4	110	1,016.00
CP15	195	10.95	CPA243084V5PKG	107	643.45	CPHU244267S4	110	1,120.10
CP2632	15	63.00	CPA243664V4	106	572.20	CPHU244267V4	110	1,086.30
CP27	195	12.50	CPA243672C96	133	830.00	CPHU244275S4	110	1,125.40
CP3253	15	83.00	CPA243672V4	106	574.90	CPHU244275V4	110	1,091.60
CP814	38, 52, 55, 56, 154	73.00	CPA243684V5PKG	107	706.45	CPHU244867S4	110	1,174.10
CPA182464V4	106	397.40	CPA244264V4	106	647.80	CPHU244867V4	110	1,136.50
CPA182472V4	106	399.95	CPA244272V4	106	650.50	CPHU244875S4	110	1,179.40
CPA182484V5PKG	107	488.80	CPA244284V5PKG	107	800.95	CPHU244875V4	110	1,141.80
CPA183064V4	106	464.40	CPA244864V4	106	698.00	CPHU245467S4	110	1,251.50
CPA183072V4	106	466.95	CPA244872V4	106	700.70	CPHU245467V4	110	1,207.30
CPA183084V5PKG	107	572.55	CPA244884V5PKG	107	863.70	CPHU245475S4	110	1,256.80
CPA183664V4	106	501.80	CPA245464V4	106	768.80	CPHU245475V4	110	1,212.60
CPA183672V4	106	504.35	CPA245472V4	106	771.50	CPHU246067S4	110	1,310.10
CPA183684V5PKG	107	619.30	CPA245484V5PKG	107	952.20	CPHU246067V4	110	1,259.50
CPA184264V4	106	576.80	CPA246064V4	106	821.00	CPHU246075S4	110	1,315.40
CPA184272V4	106	579.35	CPA246072V4	106	823.70	CPHU246075V4	110	1,264.80
CPA184284V5PKG	107	713.05	CPA246084V5PKG	107	1,017.45	CPL12	195	1.50
CPA184864V4	106	603.80	CPA247264V4PKG	106	945.80	CPL27	195	1.55
CPA184872V4	106	606.35	CPA247272V4PKG	106	948.50	CPMCHD	111	55.55
CPA184884V5PKG	107	746.80	CPA247284V5PKG	107	1,173.45	CPMDB	127	9.60
CPA185464V4	106	678.20	CPB1220	49	195.70	CPMU183667V4	107	914.90
CPA185472V4	106	680.75	CPCC1	108	5.55	CPMU183675V4	107	919.90
CPA185484V5PKG	107	839.80	CPCC10	108	55.50	CPMU184267V4	107	989.90
CPA186064V4	106	729.20	CPCC8	108	44.40	CPMU184275V4	107	994.90
CPA186072V4	106	731.75	CPDS14H11	108	79.30	CPMU184867V4	107	1,016.90
CPA186084V5PKG	107	903.55	CPDS14H6	108	73.25	CPMU184875V4	107	1,021.90
CPA187264V4PKG	106	829.00	CPDS18H11	108	81.75	CPMU213667V4	107	970.80
CPA187272V4PKG	106	831.55	CPDS18H6	108	75.65	CPMU213675DDPKG	changed to CPMU243675DDPKG	
CPA187284V5PKG	107	1,028.30	CPDS21H11	108	83.65	CPMU213675V4	107	975.90
CPA212464V4	106	434.40	CPDS21H6	108	77.55	CPMU214267V4	107	1,056.00
CPA212472V4	106	436.75	CPDS24H11	108	85.60	CPMU214275V4	107	1,061.10
CPA212484V5PKG	107	534.10	CPDS24H6	108	79.50	CPMU214867V4	107	1,088.20
CPA213064V4	106	510.20	CPFWSC244860	137	3,038.50	CPMU214875V4	107	1,093.30
CPA213072V4	106	512.55	CPH3	49	75.20	CPMU243667V4	107	988.90
CPA213084V5PKG	107	628.85	CPHU213667S4	110	1,016.10	CPMU243675DDPKG	138, 241	1,490.00
CPA213664V4	106	555.00	CPHU213667V4	110	992.50	CPMU243675V4	107	994.30
CPA213672V4	106	557.35	CPHU213675S4	110	1,021.30	CPMU244267V4	107	1,064.50
CPA213684V5PKG	107	684.85	CPHU213675V4	110	997.70	CPMU244275V4	107	1,069.90
CPA214264V4	106	640.20	CPHU214267S4	110	1,103.10	CPMU244867FXPKG	56, 139	1,068.90
CPA214272V4	106	642.55	CPHU214267V4	110	1,077.70	CPMU244867SUPKG	137	3,863.75

ALPHA NUMERICAL LISTING

Discontinued items effective 1/1/2020

CODE	PAGE	PRICE
CPMU244867V4	107	1,114.70
CPMU244875DRPKG	137, 240	1,454.15
CPMU244875PDPKG	138, 241	1,531.30
CPMU244875V4	107	1,120.10
CPMU246075DRPKG	137, 240	1,626.30
CPR14E	128	22.40
CPR18E	128	24.20
CPR21E	128	25.55
CPR2436	128	125.05
CPR24363	128	89.50
CPR2442	128	133.20
CPR24423	128	93.60
CPR2448	128	139.25
CPR24483	128	96.60
CPR24E	128	27.00
CPR24S	128	29.55
CPR30S	128	32.50
CPR36S	128	35.55
CPR42S	128	39.60
CPR48S	128	42.65
CPR54S	128	46.65
CPR60S	128	49.65
CPR72S	128	56.75
CPTR24	108	32.30
CPTR242PK	108	56.50
CPTR30	108	34.90
CPTR302PK	108	61.20
CPTR36	108	38.00
CPTR362PK	108	66.50
CPTR42	108	40.60
CPTR422PK	108	72.50
CPTR48	108	44.30
CPTR482PK	108	79.10
CPTR54	108	48.10
CPTR542PK	108	85.80
CPTR60	108	51.80
CPTR602PK	108	92.50
CPTR72	108	56.50
CPU182464V4	106	512.60
CPU182472V4	106	517.70
CPU182484V5PKG	107	624.85
CPU183064V4	106	579.60
CPU183072V4	106	584.70
CPU183084V5PKG	107	708.60
CPU183664V4	106	617.00
CPU183672V4	106	622.10
CPU183684V5PKG	107	755.35
CPU184264V4	106	692.00
CPU184272V4	106	697.10
CPU184284V5PKG	107	849.10
CPU184864V4	106	719.00
CPU184872V4	106	724.10
CPU184884V5PKG	107	882.85
CPU185464V4	106	793.40
CPU185472V4	106	798.50
CPU185484V5PKG	107	975.85
CPU186064V4	106	844.40
CPU186072V4	106	849.50

CODE	PAGE	PRICE
CPU186084V5PKG	107	1,039.60
CPU187264V4PKG	106	944.20
CPU187272V4PKG	106	949.30
CPU187284V5PKG	107	1,164.35
CPU212464V4	106	552.60
CPU212472V4	106	557.30
CPU212484V5PKG	107	672.95
CPU213064V4	106	628.40
CPU213072V4	106	633.10
CPU213084V5PKG	107	767.70
CPU213664V4	106	673.20
CPU213672V4	106	677.90
CPU213684V5PKG	107	823.70
CPU214264V4	106	758.40
CPU214272V4	106	763.10
CPU214284V5PKG	107	930.20
CPU214864V4	106	790.60
CPU214872V4	106	795.30
CPU214884V5PKG	107	970.45
CPU215464V4	106	875.40
CPU215472V4	106	880.10
CPU215484V5PKG	107	1,076.45
CPU216064V4	106	933.60
CPU216072V4	106	938.30
CPU216084V5PKG	107	1,149.20
CPU217264V4PKG	106	1,049.40
CPU217272V4PKG	106	1,054.10
CPU217284V5PKG	107	1,293.95
CPU242464V4	106	561.60
CPU242472V4	106	567.00
CPU242484V5PKG	107	684.40
CPU243064V4	106	640.80
CPU243072V4	106	646.20
CPU243084V5PKG	107	783.40
CPU243664V4	106	691.20
CPU243672C96	133	980.00
CPU243672V4	106	696.60
CPU243684V5PKG	107	846.40
CPU244264V4	106	766.80
CPU244272V4	106	772.20
CPU244284V5PKG	107	940.90
CPU244864SUPKG	137	3,566.05
CPU244864V4	106	817.00
CPU244872V4	106	822.40
CPU244884V5PKG	107	1,003.65
CPU245464V4	106	887.80
CPU245472V4	106	893.20
CPU245484V5PKG	107	1,092.15
CPU246064V4	106	940.00
CPU246072V4	106	945.40
CPU246084V5PKG	107	1,157.40
CPU247264V4PKG	106	1,064.80
CPU247272V4PKG	106	1,070.20
CPU247284V5PKG	107	1,313.40
CR12	84	314.15
CRPHDG2878	76, 233	27.95
CSDBA	128	5.95
CSDBS	128	5.95

CODE	PAGE	PRICE
CSDDC	changed to CSDDC24	
CSDDC24	138, 241	67.00
CSDDC245	138, 241	335.00
CSDDC5	changed to CSDDC245	
CSDR7	137, 240	57.70
CSDR73	137, 240	173.10
CSDR8	138, 241	46.35
CSDR84	138, 241	185.40
CSEQ3	Discontinued	
CSFF	127	33.00
CSFLEXMERCH	56	1,165.00
CSHDF	127	33.00
CSID3	127	2.30
CSID6	127	2.30
CSMHDD	127	11.00
CSMHDTK10	111	638.60
CSMHDTK12	111	736.45
CSMHDTK145	111	829.15
CSMHDTKE4	111	240.90
CSMHDTKE5	111	257.25
CSMHDTKE6	111	305.40
CSR3	42	520.15
CSR5	42	540.75
CSSC244818	129	659.20
CSSD188	127	17.50
CSSD218	127	19.05
CSSD248	127	20.60
CSTSR	Discontinued	
CSUPR1826S6	129	180.00
CSWF	127	25.75
CSWS1436SK	140	156.95
CSWS1436VK	140	156.95
CSWS1448SK	140	180.25
CSWS1448VK	140	180.25
CSWS1836SK	140	180.25
CSWS1848SK	140	197.65
CSWS36EK	140	217.50
CSWS48EK	140	323.55
CVC55	54	3,872.80
CVC72	54	6,468.40
CVC724	54	6,468.40
D12	179	1.65
D14	179	2.05
D16	179	2.10
D24	179	2.70
D8	179	1.55
DB18263CW	170	49.25
DB18263P	170	40.60
DB18266CW	170	66.20
DBC1826CW	170	35.90
DBC1826P	170	27.30
DC10	190	16.05
DC1225	88	1,184.50
DC5	190	11.70
DC575	88	1,117.55
DC700	88	1,117.55
DC825	88	1,117.55
DCC10	190	11.45

ALPHA NUMERICAL LISTING

Discontinued items effective 1/1/2020

CODE	PAGE	PRICE	CODE	PAGE	PRICE	CODE	PAGE	PRICE
DCC5	190	8.20	EA214264V4	116	492.70	EMTR482PK	119	80.50
DCS1125	88	1,122.70	EA214272V4	116	494.60	EMTR54	119	54.35
DCS950	88	1,076.35	EA214284V5	117	609.30	EMTR542PK	119	86.20
DD1220BECW	199	79.65	EA214864V4	116	517.70	EMTR60	119	58.00
DD1220CW	199	51.75	EA214872V4	116	519.60	EMTR602PK	119	92.00
DD1220ECW	199	65.40	EA214884V5	117	640.55	EMU142427V2	139	513.60
DD1220SCW	199	65.40	EA215464V4	116	583.50	EMU143627V2	139	577.10
DD1826CW	199	72.60	EA215472V4	116	585.40	EMU144827V2	139	616.50
DG3CW	176	2.35	EA215484V5	117	722.80	EMU183670V4	117	740.90
DIV12	35, 49, 55	4.35	EA216064V4	116	628.70	EMU183678V4	117	744.90
DIV20	49	10.35	EA216072V4	116	630.60	EMU184270V4	117	798.70
DP15	190	13.75	EA216084V5	117	779.30	EMU184278V4	117	802.70
DRC2020	75, 233	57.20	EA217264V4	116	718.50	EMU184870V4	117	819.70
DRLNK	141	2.45	EA217272V4	116	720.40	EMU184878V4	117	823.70
DRS30	141	242.05	EA217284V5	117	891.55	EMU185470V4	117	877.10
DRS300	141	242.05	EA242464V4	116	371.80	EMU185478V4	117	881.10
DRS36	141	262.65	EA242472V4	116	373.75	EMU186070V4	117	916.70
DRS360	141	262.65	EA242484V5	117	458.05	EMU186078V4	117	920.70
DRS48	14	314.15	EA243064V4	116	397.40	EMU213670V4	117	784.00
DRS480	141	314.15	EA243072V4	116	399.35	EMU213678V4	117	787.70
DRS60	141	360.50	EA243084V5	117	490.05	EMU214270V4	117	849.80
DRS600	141	360.50	EA243664V4	116	440.40	EMU214278V4	117	853.50
DSRP6	186	48.55	EA243672C96	133	755.00	EMU214870V4	117	875.00
DT1220CW	199	20.85	EA243672V4	116	442.35	EMU214878V4	117	878.70
E3	79, 233	14.15	EA243684V5	117	543.80	EMU215470V4	117	940.40
EA182464V4	116	330.25	EA244264V4	116	499.20	EMU215478V4	117	944.10
EA182472V4	116	332.25	EA244272V4	116	501.15	EMU216070V4	117	985.40
EA182484V5	117	406.95	EA244284V5	117	617.30	EMU216078V4	117	989.10
EA183064V4	116	343.25	EA244864V4	116	537.60	EMU243670V4	117	798.20
EA183072V4	116	345.25	EA244872V4	116	539.55	EMU243678V4	117	802.10
EA183084V5	117	423.20	EA244884V5	117	665.30	EMU244270V4	117	856.80
EA183664V4	116	386.05	EA245464V4	116	592.40	EMU244278V4	117	860.70
EA183672V4	116	388.05	EA245472V4	116	594.35	EMU244870FXPKG	Discontinued	
EA183684V5	117	476.70	EA245484V5	117	733.80	EMU244870V4	117	895.20
EA184264V4	116	444.05	EA246064V4	116	633.20	EMU244878V4	117	899.10
EA184272V4	116	446.05	EA246072V4	116	635.15	EMU245470V4	117	950.00
EA184284V5	117	549.20	EA246084V5	117	784.80	EMU245478V4	117	953.90
EA184864V4	116	464.85	EA247264V4	116	729.60	EMU246070V4	117	990.80
EA184872V4	116	466.85	EA247272V4	116	731.55	EMU246078V4	117	994.70
EA184884V5	117	575.20	EA247284V5	117	905.30	EPP160	changed to EPP160SW	
EA185464V4	116	522.45	ECC1	118	5.95	EPP160SW	13	78.00
EA185472V4	116	524.45	ECC10	118	59.50	EPP180	changed to EPP180SW	
EA185484V5	117	647.20	ECC8	118	47.60	EPP180CLSW	13	94.00
EA186064V4	116	562.05	EDBA	128	4.55	EPP180LHSW	13	115.00
EA186072V4	116	564.05	EDBS	128	4.55	EPP180LID	15	25.00
EA186084V5	117	696.70	EDS14H10	118	57.60	EPP180SW	13	85.00
EA187264V4	116	639.25	EDS14H6	118	52.80	EPP180XLTSW	13	100.00
EA187272V4	116	641.25	EDS18H10	118	59.30	EPP260	changed to EPP260SW	
EA187284V5	117	793.20	EDS18H6	118	54.50	EPP260SW	13	52.00
EA212464V4	116	361.30	EDS21H10	118	60.70	EPP280	changed to EPP280SW	
EA212472V4	116	363.20	EDS21H6	118	55.95	EPP280SW	13	58.00
EA212484V5	117	445.05	EDS24H10	118	62.05	EPP280WSTSW	13	66.00
EA213064V4	116	377.70	EDS24H6	118	57.25	EPP300	13	296.00
EA213072V4	116	379.60	EMTR36	119	43.50	EPP3253DIV	15	28.00
EA213084V5	117	465.55	EMTR362PK	119	69.00	EPP400	13	332.00
EA213664V4	116	427.10	EMTR42	119	47.15	EPPBEVH1	14	6.50
EA213672V4	116	429.00	EMTR422PK	119	74.80	EPPBEVH2	14	13.00
EA213684V5	117	527.30	EMTR48	119	50.75	EPPBEVH5	14	32.50

ALPHA NUMERICAL LISTING

Discontinued items effective 1/1/2020

CODE	PAGE	PRICE
EPPCTL	15	55.00
EPPCTLPKG	15	159.25
EPPCTS	15	52.00
EPPCTSPKG	15	156.00
EPPID5	15	9.00
EPPMBWSTSW	14	80.00
ES28	53	1,395.65
ES28RL	53	1,859.15
ESR14E	128	22.40
ESR18E	128	24.20
ESR21E	128	25.55
ESR2436	128	125.05
ESR24363	128	89.50
ESR2442	128	133.20
ESR24423	128	93.60
ESR2448	128	139.25
ESR24483	128	96.60
ESR24E	128	27.00
ESR24S	128	29.55
ESR30S	128	32.50
ESR36S	128	35.55
ESR42S	128	39.60
ESR48S	128	42.65
ESR54S	128	46.65
ESR60S	128	49.65
ESR72S	128	56.75
ESU182464V4	116	416.90
ESU182472V4	116	420.90
ESU182484V5	117	509.40
ESU183064V4	116	429.90
ESU183072V4	116	433.90
ESU183084V5	117	525.65
ESU183630V2	139	298.40
ESU183664V4	116	472.70
ESU183672V4	116	476.70
ESU183684V5	117	579.15
ESU184264V4	116	530.70
ESU184272V4	116	534.70
ESU184284V5	117	651.65
ESU184830V2	139	336.70
ESU184864V4	116	551.50
ESU184872V4	116	555.50
ESU184884V5	117	677.65
ESU185464V4	116	609.10
ESU185472V4	116	613.10
ESU185484V5	117	749.65
ESU186064V4	116	648.70
ESU186072V4	116	652.70
ESU186084V5	117	799.15
ESU187264V4	116	725.90
ESU187272V4	116	729.90
ESU187284V5	117	895.65
ESU212464V4	116	450.20
ESU212472V4	116	454.00
ESU212484V5	117	549.60
ESU213064V4	116	466.60
ESU213072V4	116	470.40
ESU213084V5	117	570.10

CODE	PAGE	PRICE
ESU213664V4	116	516.00
ESU213672V4	116	519.80
ESU213684V5	117	631.85
ESU214264V4	116	581.60
ESU214272V4	116	585.40
ESU214284V5	117	713.85
ESU214864V4	116	606.60
ESU214872V4	116	610.40
ESU214884V5	117	745.10
ESU215464V4	116	672.40
ESU215472V4	116	676.20
ESU215484V5	117	827.35
ESU216064V4	116	717.60
ESU216072V4	116	721.40
ESU216084V5	117	883.85
ESU217264V4	116	807.40
ESU217272V4	116	811.20
ESU217284V5	117	996.10
ESU242464V4	116	461.40
ESU242472V4	116	465.30
ESU242484V5	117	563.35
ESU243064V4	116	487.00
ESU243072V4	116	490.90
ESU243084V5	117	595.35
ESU243664V4	116	530.00
ESU243672C96	133	865.00
ESU243672V4	116	533.90
ESU243684V5	117	649.10
ESU244264V4	116	588.80
ESU244272V4	116	592.70
ESU244284V5	117	722.60
ESU244864V4	116	627.20
ESU244872V4	116	631.10
ESU244884V5	117	770.60
ESU245464V4	116	682.00
ESU245472V4	116	685.90
ESU245484V5	117	839.10
ESU246064V4	116	722.80
ESU246072V4	116	726.70
ESU246084V5	117	890.10
ESU247264V4	116	819.20
ESU247272V4	116	823.10
ESU247284V5	117	1,010.60
ETR24	119	28.30
ETR242PK	119	53.90
ETR30	119	30.60
ETR302PK	119	58.40
ETR36	119	31.80
ETR362PK	119	60.70
ETR42	119	34.00
ETR422PK	119	64.80
ETR48	119	37.10
ETR482PK	119	70.70
ETR54	119	40.20
ETR542PK	119	76.70
ETR60	119	43.30
ETR602PK	119	82.70
ETR72	119	49.50

CODE	PAGE	PRICE
FR258	77	41.25
FSG480	50	406.85
FSG720	50	520.15
FWC56	77, 84	4.80
GB1200CW	176	4.90
GB850CW	176	4.15
GBBP111417	10	150.00
GBBP151417	10	160.00
GBCRC272165	135	210.00
GBD101011	8	60.00
GBD121515	8	85.00
GBD13913	8	75.00
GBD151212	8	80.00
GBD181412	8	90.00
GBD211414	8	110.00
GBD211417	8	110.00
GBD211517	8	250.00
GBFLG	9	98.00
GBFMD	9	65.00
GBFSM	9	53.00
GBIRC272165	136	585.00
GBLLG	9	109.00
GBLMD	9	101.00
GBLSM	9	98.00
GBP1018	7	125.00
GBP216	7	40.00
GBP220	7	65.00
GBP318	7	50.00
GBP518	7	70.00
GBPP216	7	170.00
GBPP318	7	180.00
GBTPLG	9	109.00
GBTPMO	9	101.00
GBTPSM	9	98.00
GELHC1014	9	25.00
GELHC57	9	15.00
GELHC711	9	20.00
GK2000	74	17.90
HBR258	76, 78	25.90
HBR414	76	41.70
HBR578	76	53.75
HBR712	76	66.20
HE3	79	12.50
HFR258	77	35.60
HK39	184	30.50
HK39B	228	10.95
HK93BCW	184	15.70
HK93CW	184	28.95
HP2632	15, 38	65.00
HT10CW	178	2.81
HT120CW	178	2.94
HT12CW	178	2.88
HT14CW	178	3.23
HT16CW	178	3.76
HT22CW	178	4.70
HT5CW	178	2.58
HT8CW	178	2.70
HWAPR	43	283.25

ALPHA NUMERICAL LISTING

Discontinued items effective 1/1/2020

CODE	PAGE	PRICE	CODE	PAGE	PRICE	CODE	PAGE	PRICE
HWATD	43	370.80	MDC1520T16	238	3,692.55	PCUHH2	changed to PCUHH3	
IB32	171	427.45	MDC1520T30	238	6,422.05	PCUHH3	19	8,301.80
IB36	171	437.75	MDC24	44	2,652.25	PCULC	19	7,416.00
IB44	171	442.90	MDC24F	44	2,652.25	PCULC2	changed to PCULC3	
IBS20	171	386.25	MDC24R	44	194.00	PCULC3	19	7,416.00
IBS27	171	396.55	MDCPC9CW	185	8.75	PCULH	19	5,356.00
IBS37	171	437.75	MDSB16	227	6.35	PCULH2	changed to PCULH3	
IBSD37	172	715.00	MDSB5	227	3.25	PCULP	19	3,914.00
IBSF27	171	412.00	MDSB5C	226	180.00	PCUPC	19	8,657.15
ICS100L	66	1,071.20	MDSB9	227	3.25	PCUPC2	changed to PCUPC3	
ICS100L4S	66	1,102.10	MDSB9C	226	230.40	PCUPC3	19	8,657.15
ICS125L	66	1,096.95	MDSCDB9	228, 232	97.85	PCUPH	19	7,477.80
ICS125LB	66	1,174.20	MDSCDC9X1	232	8,500.00	PCUPH2	changed to PCUPH3	
ICS125T	66	1,163.90	MDSD9	227, 229	19.10	PCUPH3	19	7,477.80
ICS175L	66	1,302.95	MDSHB5	226	3.25	PCUPP	19	6,216.05
ICS175LB	66	1,359.60	MDSHB9	226	3.25	PCUTOW	17	1,450.00
ICS175T	66	1,369.90	MDSHD9	226, 229	19.10	PCUTOWSP	17	1,600.00
ICS175TB	66	1,457.45	MDSHM8	226	3.25	PE600CW	182	9.35
ICS200TB	66	1,493.50	MDSL9	229	8.65	PL60CW	182	9.35
KK1200	74	16.85	MDSL9	227, 229	14.40	PPB15	187	76.65
KSC402	53	5,731.95	MDSM8	227	3.25	PPB18	187	101.10
KVC854	52	7,889.80	MDSM8CNL	266	372.00	PPB23	187	173.90
KVC854C	52	10,763.50	MDSP9	229	44.65	PR314	77	41.25
KVC856	52	7,889.80	MDSPC9	229	30.90	PR500	77, 233	58.60
KVC856C	52	10,763.50	MDSPL	229	84.35	PR59314	77	41.25
KWS40	53	2,750.10	MDSPLT9	226, 229	194.65	PR59500	77	58.60
LCDCH	43	91.65	NT10	178, 230	1.95	PS1014	218	6.65
LCDCH10	43	133.90	NT12	178, 230	2.05	PSB10	192	12.30
LCDES	43	17.55	NT14	178	2.35	PSB12	192	15.90
LD105	195	3.40	NT16	178	2.45	PSB15	193	25.90
LD105A	195	4.90	NT20	178	3.00	PSB18	193	41.25
LD130	195	3.80	NT5	178, 230	1.60	PSB23	193	62.85
LD85	195	3.40	NT8	178, 230	1.65	PSB6	192	3.65
LD85A	195	4.90	NT9	178, 230	1.80	PSB8	192	6.25
LDT10	177	2.20	OETR314	77	40.40	PT1014	214	14.10
LDT12	177	2.25	P320CW	182	10.70	PT1100	214	10.95
LDT16	177	2.70	P480CW	182	12.90	PT1216	214	15.35
LDT22	177	3.30	P600CW	182	14.05	PT1400	214	14.70
LDT5	177	1.75	P60CW	182	15.75	PT1418	214	19.45
LDT6	177, 230	1.90	P64CW	182	15.75	PT1600	214	19.85
LDT9	177, 230	2.20	PC34CW	182	9.50	PWB22	43, 186	28.40
LED54LIGHTPKG	Discontinued		PC64CW	182	20.25	QCSB	90	90.00
LT10	179, 230	2.25	PCMC	19	2,849.00	QCTB	90	103.00
LT12	179, 230	2.45	PCMC2	changed to PCMC3		R1000LCD	43	113.30
LT14	179	2.60	PCMC3	19	2,849.00	R500LCD	43	101.95
LT16	179	2.90	PCMH	19	1,670.65	RD1200CW	199	29.95
LT22	179	3.25	PCMH2	changed to PCMH3		RD1220CW	199	54.75
LT6	179, 230	2.00	PCMH3	19	1,670.65	RD1220CWH	199	77.90
LT8	179	2.15	PCUCC	19	12,962.55	RD1826CW	199	70.95
MCCH	173	20.00	PCUCC2	changed to PCUCC3		RD1826CWH	199	82.80
MDC1411T60	239	6,360.25	PCUCC3	19	12,962.55	RD926CW	199	48.20
MDC1418S20	237	3,934.60	PCUCH	19	11,783.20	RFS1	150	4.45
MDC1418T16	238	3,599.85	PCUCH2	changed to PCUCH3		RFS12	150	15.95
MDC1418T30	238	6,360.25	PCUCH3	19	11,783.20	RFS12PP	150	17.00
MDC1520S10	236	2,662.55	PCUHC	19	11,783.20	RFS12SCPP	148	7.50
MDC1520S10D	235	4,244.20	PCUHC2	changed to PCUHC3		RFS18	150	19.35
MDC1520S10HD	236	3,110.60	PCUHC3	19	11,783.20	RFS18PP	150	20.60
MDC1520S20	237	4,001.55	PCUHH	19	8,301.80	RFS1PP	150	4.60

ALPHA NUMERICAL LISTING

Discontinued items effective 1/1/2020

CODE	PAGE	PRICE
RFS1SCPP	148	2.20
RFS2	150	4.80
RFS22	150	22.80
RFS22PP	150	24.20
RFS2PP	150	5.10
RFS2SCPP	148	3.40
RFS4	150	5.45
RFS4PP	150	5.90
RFS6	150	6.80
RFS6PP	150	7.15
RFS6SCPP	148	3.50
RFS8	150	8.90
RFS8PP	150	9.55
RFSC1	150	1.50
RFSC12	150, 186	5.30
RFSC12PP	150	5.80
RFSC1PP	150	1.70
RFSC2	150	1.55
RFSC2PP	150	1.75
RFSC6	150	2.20
RFSC6PP	150	2.50
RFSCW1	148	6.65
RFSCW12	148	32.55
RFSCW18	148	44.65
RFSCW2	148	9.20
RFSCW22	148	51.40
RFSCW4	148	15.55
RFSCW6	148	18.20
RFSCW8	148	23.05
RFSCWC1	148	2.40
RFSCWC12	148	12.45
RFSCWC2	148	4.30
RFSCWC6	148	5.45
RSB1014CW	193	18.50
RSB10CW	193	16.20
RSB12CW	193	27.00
RSB1419CW	193	30.00
RSB15CW	193	34.90
RSB18CW	193	50.25
RSB23CW	193	75.70
RSB6CW	193	4.55
RSB8CW	193	8.85
RSB912CW	193	12.65
SB55	194	1.95
SB60	194	2.35
SB80	194	4.80
SBH15	49	75.20
SBH18	49	75.20
SC337	90	1,015.00
SC337S	90	1,040.00
SCP12CW	171	7.25
SCP24CW	171	9.20
SCP64CW	171	13.10
SCP6CW	171	6.70
SFC12	146	6.70
SFC12SCPP	144	6.70
SFC12SCPP441	174	7.10
SFC2	146	3.70

CODE	PAGE	PRICE
SFC2SCPP	144	3.70
SFC2SCPP441	174	3.90
SFC6	146	4.60
SFC6SCPP	144	4.60
SFC6SCPP441	174	4.90
SFG1012	191	18.15
SFG1015	191	19.30
SFG1220	191	24.65
SFG820	191	20.55
SFR1012	191	18.15
SFT1010	Discontinued	
SFT1212	Discontinued	
SFT1515	Discontinued	
SFV1015	191	18.85
SLL30	155	180.25
SPA14	196	12.60
SPASL14	196	12.60
SPO10CW	196	2.85
SPO11CW	196	3.50
SPO13	196	11.25
SPO13CW	196	6.00
SP08CW	196	2.60
SPO10CW	196	2.85
SPO11CW	196	3.50
SPOP13	196	11.25
SPOP13CW	196	6.00
SRB13	186	3.65
SRB13CW	186	4.45
SRB5	186	1.95
SRB5CW	186	2.25
SSR1	19	84.45
SSR8	19	612.85
TC1418	84	1,256.60
TDC2029	84	1,117.55
TDC30	84	1,462.60
TDCR12	84	1,467.75
TG6	197	2.50
TG9	197	4.00
TGA11	197	4.65
TGA8	197	3.95
TGG6	197	3.95
TGG9	197	4.25
UC1000	42	453.20
UC1000CVR	42	130.00
UC250	42	298.70
UC250CVR	42	130.00
UC500	42	334.75
UC500CVR	42	130.00
UCR10AR8	133	65.00
UCR10R8	133	110.00
UPC100	35	468.65
UPC1200	27	2,029.10
UPC140	35	417.15
UPC160	35	422.30
UPC1600	27	2,920.05
UPC1600HD	27	3,074.55
UPC1600SP	27	3,187.85
UPC180	35	432.60

CODE	PAGE	PRICE
UPC300	30	515.10
UPC300DIV	38	80.35
UPC400	32	606.90
UPC400SP	32	673.20
UPC600	27	1,318.40
UPC800	27	1,560.45
UPC800SP	27	1,678.90
UPCGL1600SP	27	2,945.80
UPCH1600	25	6,051.25
UPCH16002	25	6,051.25
UPCH16002HD	25	6,221.20
UPCH16002SP	25	6,236.65
UPCH1600HD	25	6,221.20
UPCH1600SP	25	6,236.65
UPCH400	25	1,519.25
UPCH4002	25	1,519.25
UPCH800	25	3,733.75
UPCH8002	25	3,733.75
UPCHT1600	25	4,712.25
UPCHT16002	25	4,712.25
UPCHT16002HD	25	4,882.20
UPCHT1600HD	25	4,882.20
UPCHT800	25	2,842.80
UPCHT8002	25	2,842.80
UPCHW400	25	1,725.25
UPCHW4002	25	1,725.25
UPCS140	35	278.10
UPCS160	35	288.40
UPCS180	35	309.00
UPCS400	33	551.05
UPCS400CK	33	143.20
UPR1826F20	135	715.00
UPR1826F40	135	725.00
UPR1826FA20	135	925.00
UPR1826FA40	135	985.00
UPR1826FP20	135	765.00
UPR1826FP40	135	775.00
UPR1826FPA20	135	995.00
UPR1826FPA40	135	1,055.00
UPR1826H12	136	510.00
UPR1826H20	136	565.00
UPR1826HP12	136	560.00
UPR1826HP20	136	615.00
UPR1826U15	136	540.00
UPR1826U8	136	495.00
UTHSTP	83	17.50
VBR5	48	3,373.25
VBR6	48	3,512.30
VBRC	48	185.40
VBRC90	48	319.30
VBRCVR5	49	310.00
VBRCVR6	49	340.00
VBRHD5	48	3,615.30
VBRHD6	48	3,759.50
VBRL5	48	3,373.25
VBRL6	48	3,512.30
VBRLHD5	48	3,615.30
VBRLHD6	48	3,759.50

CODE	PAGE	PRICE
VBRR5	49	448.05
VBRR6	49	478.95
VBRSHTS	49	280.00
VBRT5	48	2,487.45
VBRT6	48	2,631.65
VBRTBL	49	484.10
VBRTCVR5	49	165.00
VBRTCVR6	49	180.00
VBRTHD5	48	2,734.65
VBRTHD6	48	2,878.85
VBRTL5	48	2,379.30
VBRTL6	48	2,523.50
VBRTLHD5	48	2,626.50
VBRTLHD6	48	2,770.70

CODE	PAGE	PRICE
VBRU5	48	4,300.25
VBRU6	48	4,593.80
VBRUHD5	48	4,542.30
VBRUHD6	48	4,841.00
VBRUT5	48	2,909.75
VBRUT6	48	3,038.50
VBRUTHD5	48	3,156.95
VBRUTHD6	48	3,285.70
VBRWC	49	139.05
VCS	48	2,538.95
VCS32CNT	48	329.60
VCS32KEYT	49	107.10
VCS32R	49	370.80
VCSCNL	48	401.70

CODE	PAGE	PRICE
VCSCVR	49	165.00
VCSHD	48	2,796.45
VCSWR	48	2,611.05
VCSWRHD	48	3,290.85
WC100CW	187	43.45
WC100CWNH	187	25.00
WCR1220	52, 55	108.15
WW1000	181	10.75
WW1000L	181	1.00
WW1000LS	181	1.00
WW1500	181	14.00
WW250	181	4.80
WW250L	181	1.00
WW500	181	7.95

General Terms

Cambro products may be combined to obtain prepaid freight.

Specifications, features and equipment shown are based upon the latest information available. Cambro Manufacturing Company reserves the right to make changes at any time, without notice, to price, colors, specifications, accessories and materials. For additional information, please contact your authorized Cambro representative.

Freight

Freight is free on shipments totaling **\$4,000** net or more, based on a single order for single delivery **within the continental U.S.A. (48 Contiguous United States)**. Orders for shipments totaling less than **\$4,000** are F.O.B. Any items back ordered from a "free freight order" will be forwarded transportation charges paid. Add-ons are not allowed on "free freight order backorders".

Return Merchandise Policy

No merchandise may be returned without written authorization. Authorized returns must be shipped freight prepaid. All returned goods must be new and unused, in full case quantities and original packaging, they are subject to a minimum 15% repackaging charge plus outbound freight. Return of goods must be requested within 60 days of invoice. Special or non-standard items are not returnable. Electrical components returned are subject to inspection prior to credit being issued.

Assessorial Charges

From time to time, motor carriers will charge for services that are beyond the scope of a normal delivery. In the event that this happens, Cambro Mfg. reserves the right to bill the customer for these charges. Services that fall under this program would include:

- Sort & Segregation of product at customer's dock.
- Lift-gate required to off load the product from the truck.
- Inside delivery requests.

These charges are considered to be assessorial charges and are not included in the prepaid freight program.

Broken Cartons

Orders calling for less than standard pack will be charged \$10.00 net per broken case. Broken cartons are not available on any special order items, the assortment pack, custom imprinted ladles, 4 pack booster chairs, disposable lids or on StoreSafe labels. **There is no broken carton charge on Camracks.**

Replacement Parts

Visit www.cambro.com for replacement parts information on Cambro products.

Product Accessories

Contents and accessories shown in photos are not included, except where noted.

Cambro® Warranty

Cambro offers a 5-year pro-rated warranty against damage or manufacturer's defects found in excess to normal wear and tear on our Camtrays®, Camtread® trays and Dinnerware. Commercial Electrical Equipment models hold a 1-year warranty. Non-Skid Versa Camtrays, Tongs, Camwear® Food Storage Pans, all high heat material products, Squares, Rounds and Lids have a 2-year pro-rated warranty. All Camshelving® Series have a 1-year warranty on workmanship and a lifetime limited warranty against rust and corrosion, excluding mobile posts. For all other Cambro products, Cambro warrants to the original buyer a 3-year pro-rated warranty unless otherwise noted. If product proves defective during this time, Cambro grants a pro-rated credit of the original price toward replacement product. The warranty applies on all Cambro products only when used under normal foodservice industry conditions.

Note: Temperature ranges noted throughout this catalog are based on specific test criteria and provide a general guideline. Individual use may vary due to differences in loading temperatures or ambient temperature.

STEMWARE AND GLASS SIZING REFERENCE GUIDE

HALF SIZE RACKS Maximum Compartment Width

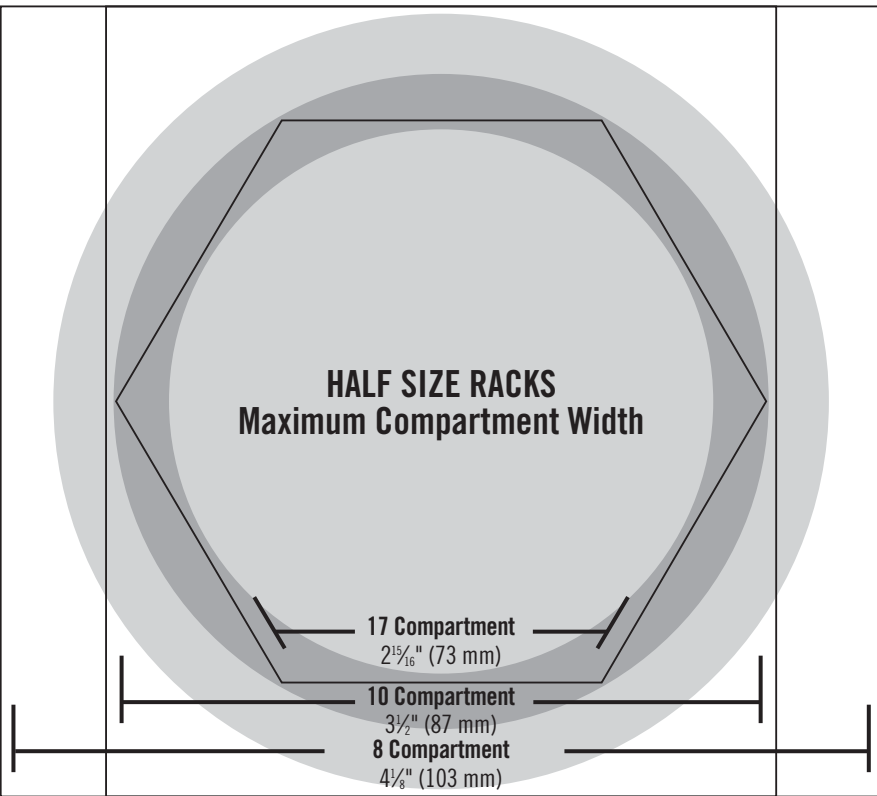

To Determine Compartment Size

• **Half Size Racks:**
Place glass or stemware upside down over circle chart. Look down on the glass. Whatever circle the largest diameter of the glass fits within will determine the number of compartments.

• **Full Size Racks:**
Place glass or stemware upside down over circle chart. Look down on the glass. Whatever circle the largest diameter of the glass fits within will determine the number of compartments.

Use the vertical guide marks at right to determine item height and appropriate rack number.

FULL SIZE RACKS Maximum Compartment Width

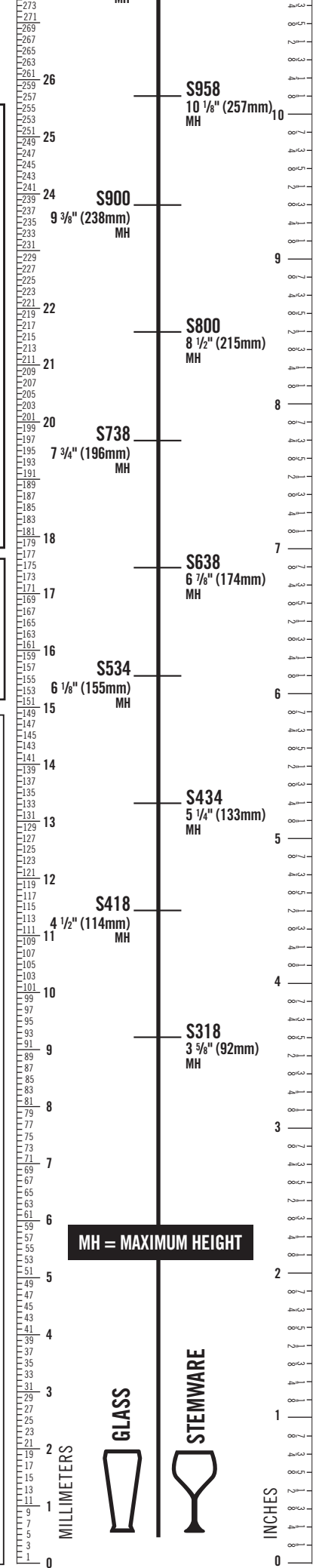
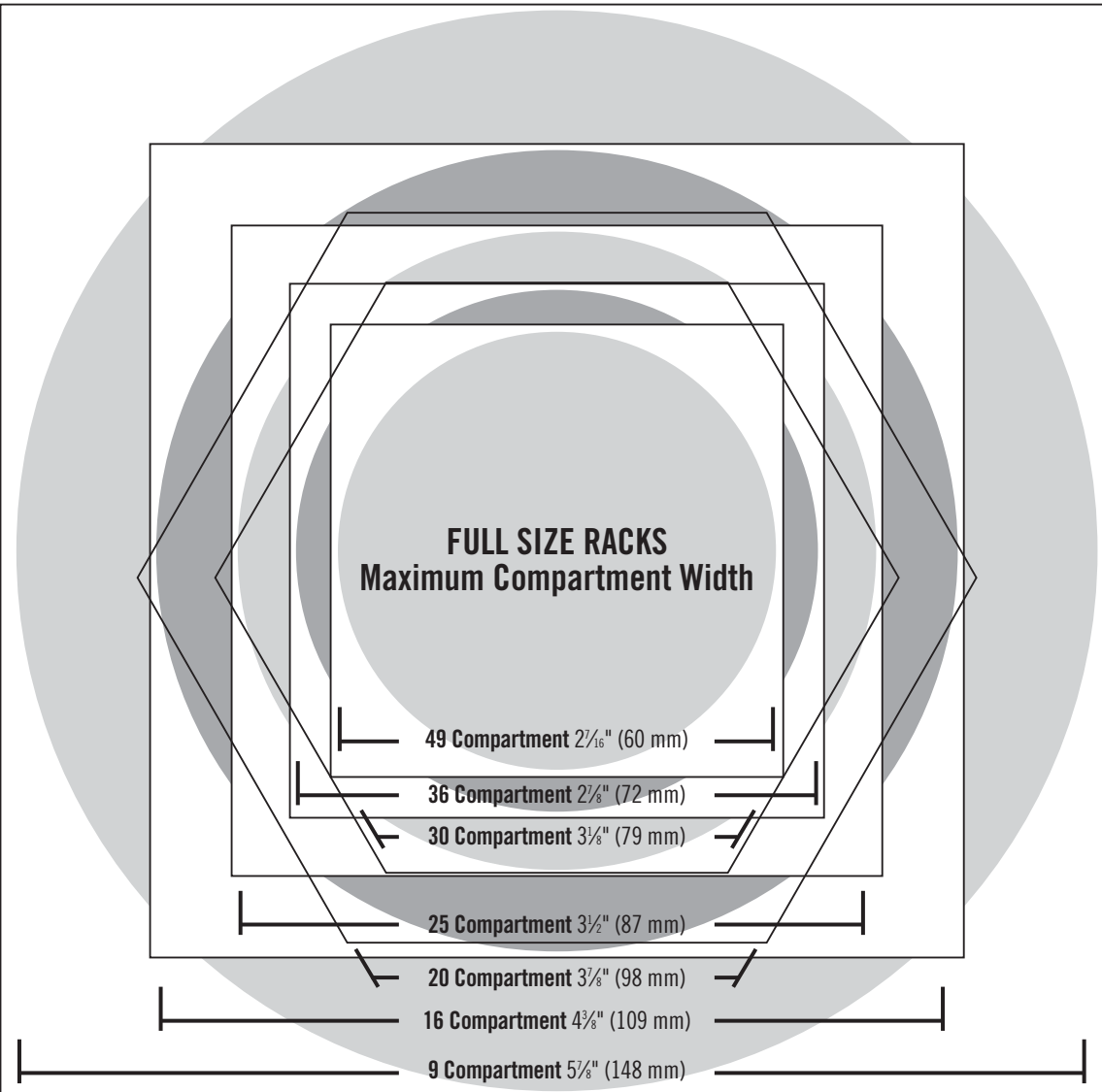

CAMRACK® CUP RACK REFERENCE GUIDE



16

FULL RACK

COMPARTMENT

4³/₈" x 3¹/₂" (11,1 x 8 cm)

To determine Cup compartment size:
Turn cup or coffee mug upside down and place diagonally in square. Align handle with arrow in square. Cup or mug and handle must fit completely within boundaries of a square in order to ensure the right rack.

QUICK GUIDE

Full Size Cup Racks (C)

Maximum Cup Width	Number of Compartments	Maximum Cup Height		
		2 ⁵ / ₈ " (6,6 cm)	4 ¹ / ₄ " (10,7 cm)	5 ⁷ / ₈ " (14,9 cm)
4 ³ / ₈ " (11,1 cm)	16	16C258	16C414	16C578
3 ¹ / ₂ " (8,8 cm)	20	20C258	20C414	20C578



20

FULL RACK

COMPARTMENT

4³/₈" x 3⁷/₁₆" (11,1 x 8,73 cm)



10

HALF RACK

COMPARTMENT

4¹/₈" x 3¹/₂" (10,4 x 8,8 cm)

8

HALF RACK

COMPARTMENT

4⁷/₁₆" x 4¹/₈" (11,3 x 10,4 cm)

QUICK GUIDE

Half Size Cup Racks (HC)

Maximum Cup Width	Number of Compartments	Maximum Cup Height	
		2 ⁵ / ₈ " (6,6 cm)	4 ¹ / ₄ " (10,7 cm)
4 ¹ / ₈ " (10,4 cm)	8	8HC258	8HC414
3 ¹ / ₂ " (8,8 cm)	10	10HC258	10HC414

To Determine Cup Height:

Place base of cup or coffee mug on flat surface hold ruler vertically next to it to determine height in inches or millimeters. If the height is greater than 4¹/₄" (108 mm), additional 1⁵/₈" (41 mm) E2 and HE2 extenders may be ordered.

CAMBRO® EQUIPMENT COLOR CHART



Gray (180)



Coffee Beige (157)

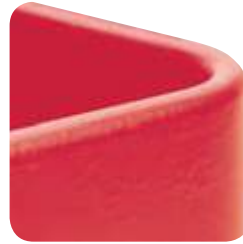

Hot Red (158)

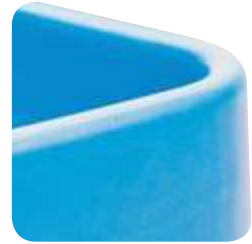

Cold Blue (159)



Speckled Gray (480)



Dark Taupe (417)



Brick Red (402)



Navy Blue (186)



Granite Gray (191)



Granite Sand (194)

Cambro provides a wide selection of colors to help you coordinate with your decor and color code items to simplify use. Color selections vary by product. Please see individual products for specific colors offered.



Slate Blue (401)



Charcoal Gray (615)



Dark Brown (131)

Due to the catalog printing process, the colors shown may not be exact. For exact colors, contact Cambro or a Cambro representative for a color chip.



Granite Green (192)



Black (110)



Kentucky Green (519)



CAMBRO U.S.A.
 5801 Skylab Road, Huntington Beach, CA 92647 P.O. Box 2000, Huntington Beach, CA 92647-2000
Telephone: (714) 848-1555 **Toll Free:** (800) 854-7631 **FAX:** (714) 842-3430
Customer Service: (800) 833-3003
 © Cambro Manufacturing Company. Printed in the U.S.A.
CAT2020/21 US All prices are in US dollars. All prices are subject to change without prior notice.



For a Complete List of U.S.A. and International Representatives Please Visit www.cambro.com

NEW FROM CAMBRO®



Cambro GoBags® Pizza Bags,
Delivery Bags and Backpacks **6 - 10**



Cam GoBox® for Milk Crate,
Beverage Holder and Camdollies® **14**



Cam GoBox® for Delivery,
Camchiller® Insert Kits and Color Lids **13, 15**



Compact Dish Caddy S-Series
86



Service Cart Pro
90

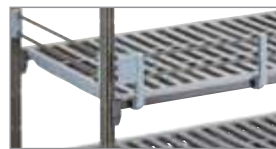

Basics Plus Shelf Rail Kit
128



Ultimate Sheet Pan Rack
for Single Shelf **129**



Ultimate #10 Can Rack
131 - 133



Ultimate Sheet Pan Rack
134 - 136



Undercounter Shelving
139



High Heat Measuring
Cups and Cover **173**



Décor Series Camtrays® and
EpicTread™ Camtrays **209, 225**



Harbor White Collection
226



Air Curtain Ultra™
234