

dyson airblade

The fastest to dry
hands hygienically
with HEPA filtered air.¹



The Dyson Airblade Tap hand dryer installed in the washrooms of a leading F1 team.



Why do we put up with products that don't work properly?

In 1907, paper towels were introduced to washrooms. The electric hand dryer made its first appearance in 1948. But both have changed little since – they can still be expensive, unhygienic and harmful to the environment.

At Dyson, our engineers didn't think that was good enough. So in 2006, they put a century of poor performing hand drying methods to rest – with the invention of Airblade™ technology.

The problems with paper towels

Paper towels are expensive, have a high impact on the environment and cause extra washroom maintenance through mess and blockages.

And because dispensers are often found empty, leaving no way to dry hands, paper towels can create hygiene issues beyond the washroom.

Did you know?

Ensuring hands are dry is crucial for maintaining hygiene levels, as damp hands can spread up to 1,000 times more bacteria to the surfaces they touch.



The problems with other hand dryers

Warm air dryers

Warm air dryers are slow. Which means they're energy hungry, expensive to run and unhygienic.

Dry times can take up to 25 seconds, so many users give up before their hands are dry – risking increased spread of bacteria.

Jet dryers

Other jet dryers might look like a Dyson Airblade™ hand dryer, but when it comes to performance, there's no comparison. Thanks to weak motors, most other jet dryers can't generate the fast airflow needed to dry hands quickly. They can also lack the power required to draw the air through a HEPA filter.

So most other jet dryers aren't just slower than Airblade™ technology, they're less hygienic too.

Did you know?

Public health specialists NSF state that to be certified as hygienic, a hand dryer must dry hands in 15 seconds or less.



Have you ever looked inside a drain tank?

Some hand dryers collect waste water using drain tanks. But these are unhygienic – providing the perfect breeding ground for bacteria.

Drain tanks must be emptied and cleaned regularly – adding time and effort to the washroom maintenance process, and risking spillage of waste water during disposal.



Did you know?

In recent testing, Dyson microbiologists detected greater levels of bacteria in a drain tank than levels that can be found in the average household toilet.²

² Sources: Dyson in-house testing, 2015; Scott et al., 2009; Medrano-Felix et al., 2010.

Dyson Airblade™ hand dryers work differently

Dyson digital motor V4

+ HEPA filter

+ Airblade™ technology

= The fastest to dry hands hygienically with HEPA filtered air¹

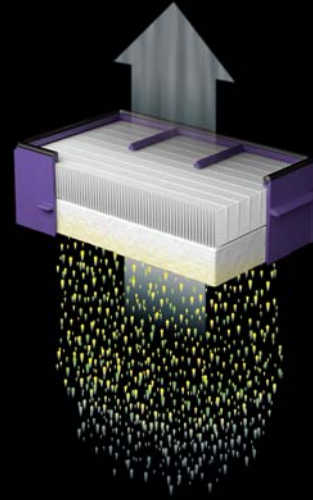
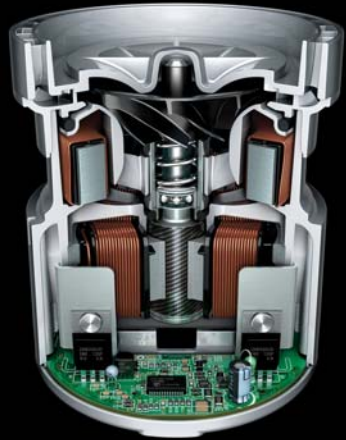

Dyson digital motor V4

Conventional motors are bulky, slow and can be inefficient. They also rely on carbon brushes, which wear out over time. The Dyson digital motor V4 is different. It's both compact and powerful, and instead of old-fashioned carbon brushes, it uses digital pulse technology to spin up to three times faster than a conventional motor.

HEPA filter

Bacteria and viruses in washrooms can cause colds, flu, sickness, diarrhoea or worse. Dyson Airblade™ hand dryers have HEPA filters installed as standard, which capture 99.97% of particles the size of bacteria as small as 0.3 microns in the washroom air. So hands are dried with cleaner air, not dirty air.

Airblade™ technology

Every second, the Dyson digital motor V4 draws in up to 35 litres of air through a HEPA filter, and forces it through apertures up to 0.8 mm wide. The result – 675 km/h sheets of filtered air that scrape water from hands, drying them quickly and hygienically.

No other hand dryer has this technology

¹Based on overall dry time performance and HEPA filtration capabilities.

Airblade™ technology has evolved

Dyson Airblade™ hand dryers are powered by the Dyson digital motor V4 – its small size and power density are what have made our hand dryer technology possible.

It means you'll now find a quiet, hands-under dryer, a hands-in machine that works in just 12 seconds,³ and even one that dries hands at the sink.

dyson airblade V

The most hygienic hand dryer is now 30% quieter.⁴

dyson airblade dB

The fastest, most hygienic hand dryer.

dyson airblade tap

Airblade™ hand drying technology in a tap.

³Dry time measured using Dyson test method 769 based on NSF P335 using a measurement of 0.1g residual moisture.

⁴Loudness reduction compared to the original Dyson Airblade V hand dryer.



Only Dyson Airblade™
hand dryers have
all these benefits.

12-14 second dry time.³

Most hygienic.

Costs less to run.

Better for the environment.

5 year warranty.

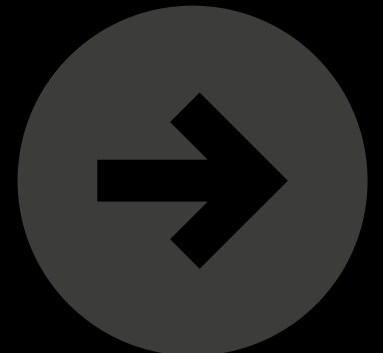

³Dry time measured using Dyson test method 769 based on NSF P335 using a measurement of 0.1g residual moisture

Other hand dryers are too slow

Testing based on NSF Protocol P335 shows that most other hand dryers are much slower than their manufacturers claim – with dry times based on drying hands without a HEPA filter. Many people give up when using a slow hand dryer. But damp hands can spread up to 1,000 times more bacteria than dry hands.



Up to
25 sec³

No HEPA filter as standard

Up to
22 sec³

Dyson hand dryers are fast

Testing based on NSF Protocol P335 shows that Dyson Airblade™ hand dryers are fast. Every second, up to 35 litres of air is forced through apertures up to 0.8 mm wide. The result – 675 km/h sheets of air that scrape water from hands, drying them quickly and hygienically.



12 sec³

HEPA filter as standard

12 sec³

HEPA filter as standard

14 sec³

HEPA filter as standard



³Dry time measured using Dyson test method 769 based on NSF P335 using a measurement of 0.1g residual moisture

NSF Protocol P335

For a more detailed overview of NSF Protocol P335 please see the reference section at the end of the brochure.

Airblade™ technology is fast and the most hygienic¹

These are the reasons why:

Dyson digital motor V4

HEPA filter

12-14 second dry time³

No drain tank

Antibacterial additive

No heating element

Touch-free operation



Damp hands can spread up to 1000 times more bacteria than dry hands.

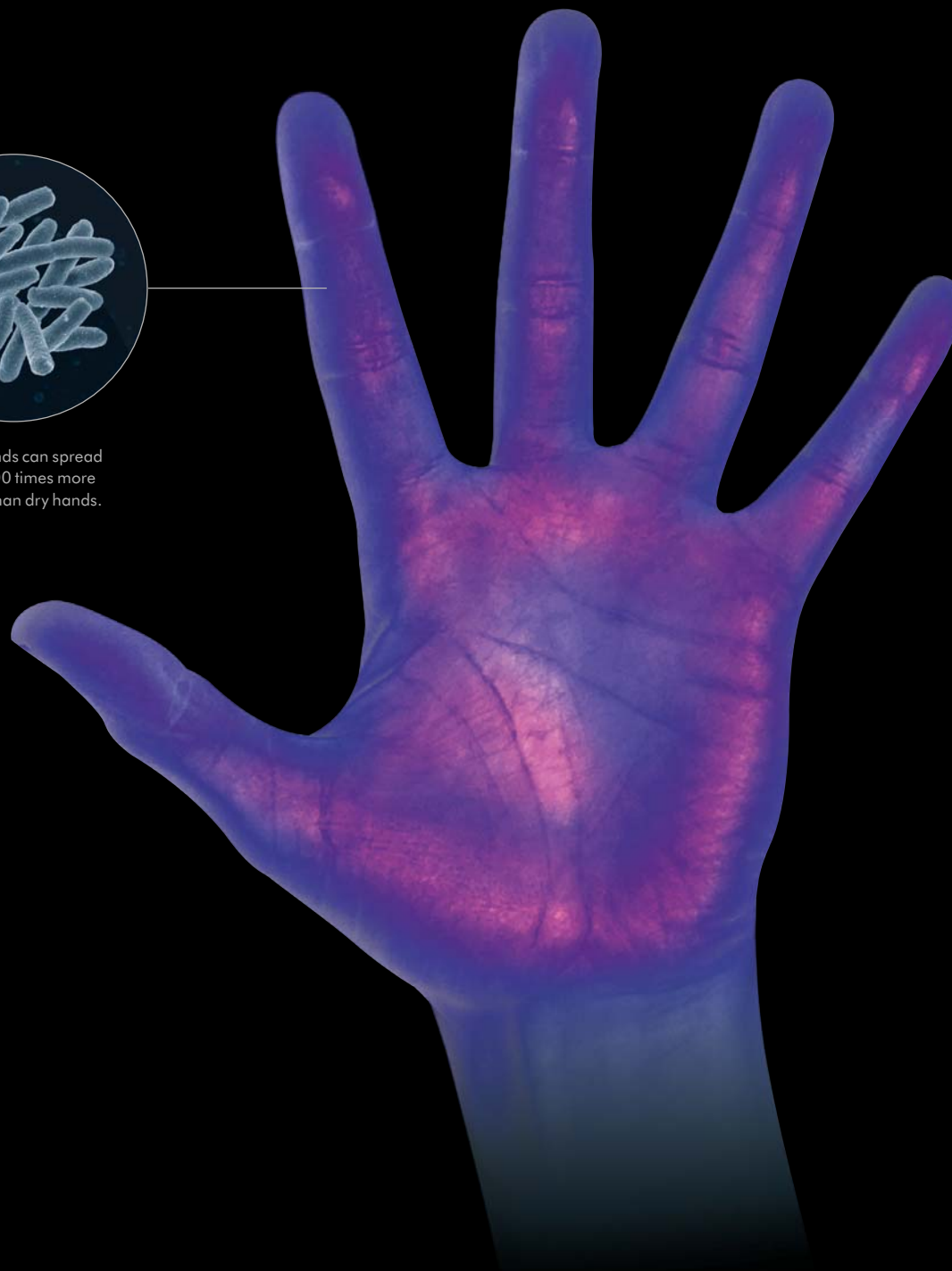

Hygienically drying hands is as important as washing them

Bacteria and viruses deposited by hands onto surfaces can survive for several hours. When others touch these contaminated surfaces, they can be transferred. Damp hands can spread up to 1,000 times more bacteria than dry hands. It's why it's important that hands are dried properly.

The most hygienic hand dryer

Dyson Airblade™ hand dryers use HEPA filters. 99.97% of particles the size of bacteria as small as 0.3 microns are captured. So hands are dried in 14 seconds³ or less using cleaner air, not dirty air. Both the Dyson Airblade V hand dryer and the Dyson Airblade dB hand dryer contain an antibacterial additive which can help prevent the growth of bacteria.

No drain tank

When you dry your hands with a Dyson Airblade V hand dryer or Dyson Airblade dB hand dryer, waste water is designed to drip onto the floor where it evaporates – so bacteria dry out and perish. But some hand dryers use drain tanks to collect waste water – providing the perfect breeding ground for bacteria. That's unhygienic.



¹Based on overall dry time performance and HEPA filtration capabilities.

³Dry time measured using Dyson test method 769 based on NSF P335 using a measurement of 0.1g residual moisture.

Proven as hygienic

Bradford University

Conclusions:

Using a Dyson Airblade™ hand dryer reduces bacteria on washed hands by up to 40%.

Study background:

Conducted by the Bradford University Infection Group, the study's findings have been peer-reviewed by the academic community and published in the Journal of Applied Microbiology.

What they studied:

Bacteria removal by the Dyson Airblade™ hand dryer.



Campden BRI

Conclusions:

Using a Dyson Airblade™ hand dryer has no significant impact on bacteria levels in washroom air compared to paper towels.

Study background:

Conducted by independent food and drink research organisation Campden BRI, whose clients include hygiene-conscious global food businesses such as Cadbury, Pepsico, Danone, Coca-Cola, Heinz and Nestlé.

What they studied:

Bacteria counts in washroom air following use of Dyson Airblade™ hand dryers and paper towels.



University of Florida

Conclusions:

The surface of a Dyson Airblade™ hand dryer is no more contaminated than any other high-touch area in the washroom.

Study background:

Conducted by an epidemiologist from the Division of Infectious Diseases at the University of Florida's College of Medicine.

What they studied:

Bacterial contamination from Dyson Airblade™ hand dryers and other hand drying methods on high-touch areas in public washrooms – including paper towel dispensers, toilets, door knobs, toilet cubicle handles, flush controls, counter tops etc.



Funding into further independent studies will continue.

The only hand dryers globally certified as hygienic by both NSF and HACCP International.

**Certified by HACCP International.
Safe for the food sector.**

The Dyson Airblade dB hand dryer and the Dyson Airblade Tap hand dryer have been certified for use in food preparation environments by HACCP International.



Certified by NSF International.

Dyson asked independent public health specialists NSF to define the criteria for a hygienic hand dryer. The result is NSF Protocol P335 – and Dyson Airblade™ hand dryers are the only hand dryers that meet every part of it.



**Other hand drying methods
are expensive to run**

Paper towels need constant restocking and disposal. Most other hand dryers are slow so they're energy-hungry.



\$1,460

per year⁵

\$157

per year⁵

Low running costs

Dyson Airblade™ hand dryers cost up to 69% less to run than other hand dryers, and up to 97% less than paper towels.⁵



\$40

per year⁵

\$31

per year⁵

\$48

per year⁵



⁵For calculations visit www.dysoncanada.ca/calcs

Higher impact on the environment

Dyson Airblade™ hand dryers produce up to 79% less CO₂ than some other hand dryers and up to 76% less than paper towels.⁶



13.9g

CO₂ per dry⁶

15.6g

CO₂ per dry⁶

8.0g

CO₂ per dry⁶

Low impact on the environment

Dyson Airblade™ hand dryers have a lower environmental impact across measures including carbon emissions and energy consumption.⁶



3.3g

CO₂ per dry⁶

2.4g

CO₂ per dry⁶

4.0g

CO₂ per dry⁶



⁶In collaboration with Carbon Trust, Dyson has produced a method to measure the environmental impact of electrical appliances and paper towels. The carbon calculations were produced using GaBi software provided by PE International, based on product use over 5 years and using the US as a representative country of use. Dry times for products were evaluated using DTM 769.

The only hand dryer certified by the Carbon Trust

Everything we make or use has a carbon footprint. It represents the total amount of carbon dioxide and other greenhouse gases generated during its life.

Working with the Carbon Trust, Dyson has measured the carbon footprint of the Dyson Airblade™ hand dryer range.

Every single component

All components inside the Dyson Airblade™ hand dryer were assessed. Materials and manufacture contribute 8% of total emissions.

Waterways vs. highways

Constant paper towel restocking relies on road transport. Dyson Airblade™ hand dryers use energy-efficient ships – representing less than 1% of total emissions.

Less energy = less carbon

Airblade™ technology has fast dry times and no energy-hungry heating elements. So it uses up to 80% less energy than warm air dryers.

End of life

With a 5 year warranty, the Dyson Airblade™ hand dryer is built to last. Even so, many components are designed to be recyclable with negligible environmental impact.



The environmental impact of paper towels

From cutting down trees, through chemical processes to disposal – using paper towels has a significant impact on the environment.

Felling trees

Trees are a major source of pulp for virgin paper towel production.

Transportation

Once trees are felled they need to be transported from the forest to the mill.

Mix with water

Lots of water and energy are needed to make paper.

Pulping and bleaching

Chemicals are also used in the bleaching process.

Maintenance

Paper towel dispensers need constant restocking.

Disposal

Most used paper towels cannot be recycled. They have to be disposed of. Used paper towels, packaging and bin liners end up in landfill or an incinerator.



5 year warranty. Unrivalled service.

Test. Test. Test.

Dyson Airblade™ hand dryers are engineered to last. They have been repeatedly tested for durability and resilience to physical abuse.

They have also been exposed to real-life environments to ensure that they can withstand the pressures of high usage.

Warranty

Thanks to this rigorous testing regime, all factory parts on Dyson Airblade™ hand dryers are guaranteed against original defects in materials and workmanship for 5 years.

Aftersales support

But if anything does go wrong with your machine, we provide repair and maintenance support through Dyson service engineers and self-service spare parts. Reducing downtime and disruption to your facilities.

Dyson Airblade dB hand dryer

5 year parts, 1 year labour.

Dyson Airblade V hand dryer

5 years parts, easy self-service.

Dyson Airblade Tap hand dryer

5 year parts and labour.

5



dyson airblade V

The most hygienic hand dryer is now 30% quieter.⁴

30% quieter

With reprogrammed digital motor technology and precision air apertures, loudness testing shows that the new Dyson Airblade V hand dryer is now 30% quieter than its predecessor.

More room. Less hassle.

With a slim, compact profile that protrudes just 4 inches from the wall, the Dyson Airblade V hand dryer takes up less space in the washroom. While its easy-mount backplate allows for easy, self-service installation, maintenance and replacement.

For full product details visit www.dysoncanada.ca



Certified by Quiet Mark

The Noise Abatement Society tested and approved the decibel levels and sound quality of the Dyson Airblade V hand dryer – awarding it the Quiet Mark. The Quiet Mark has been developed in response to public health concerns over the psycho-physiological effects of excessive or invasive sound produced by appliances.

⁴Loudness reduction compared to the original Dyson Airblade V hand dryer.

The View From the Shard

“The Dyson Airblade V hand dryers have a modern and sleek design that fits the general design of ‘The View From the Shard’ very well. Guests have told us they like the power and speed of the machines. We are very proud to be amongst the first to have these hand dryers.”

Sandy Clark
Operations Director.



The original Dyson Airblade V hand dryer.

dyson airblade dB

The fastest, most
hygienic hand dryer.

Fast drying

The original Dyson Airblade dB hand dryer produces sheets of air travelling at 675 km/h. They scrape water from the front and back of hands simultaneously, drying hands in just 12 seconds.³

Safe for the food sector

The Dyson Airblade dB hand dryer has been approved for use in food preparation environments by HACCP International.

For full product details visit
www.dysoncanada.ca



³Dry time measured using Dyson test method 769 based on NSF P335 using a measurement of 0.1g residual moisture.

Gloucester Services

"Although we had a wide range of hand dryers to choose from, our sister station has had its Dyson Airblade™ hand dryers for over 5 years and they still only have positive things to say."

Joshua Jackson,
Facilities Manager.



dyson airblade tap

Airblade™ hand drying technology in a tap. Wash and dry hands at the sink.

No waste water on the floor

With Airblade™ technology in a tap, hands can be dried at the sink in just 14 seconds.³ There's no need for users to move to a separate drying area, so no water is dripped on the floor.

Free up your washroom

Other hand drying methods take up valuable wall and floor space. With the Dyson Airblade Tap hand dryer, there's room for extra toilet cubicles and other facilities.

For full product details visit www.dysoncanada.ca



Coca-Cola London Eye

"As an iconic global landmark, The London Eye needs to meet high expectations of quality – and that extends to our washrooms. Installing the Dyson Airblade Tap hand dryer has allowed us to achieve this."

Davey Barrett,
Show Services Manager.



³Dry time measured using Dyson test method 769 based on NSF P335 using a measurement of 0.1g residual moisture.

The range

AB
14



Grey

White

The fastest, most hygienic hand dryer.

12 second dry time.³

HEPA filter captures 99.97% of particles the size of bacteria as small as 0.3 microns.

Tested and certified by NSF International.

Certified for use in food environments by HACCP International.

Costs just \$40 to run per year.⁵

Small carbon footprint.

Tough and durable.

Touch-free operation.

Contains antibacterial additive.

HU
O2



Sprayed nickel

White

The most hygienic hand dryer is now 30% quieter.⁴

Certified by Quiet Mark.

HEPA filter captures 99.97% of particles the size of bacteria as small as 0.3 microns.

Tested and certified by NSF International.

12 second dry time.³

Costs just \$31 to run per year.⁵

Small carbon footprint.

Slim profile – just 4 inches deep, no recessing required.

Touch-free operation.

Contains antibacterial additive.

AB
O9 Short



AB
10 Long



AB
11 Wall



Airblade™ hand drying technology in a tap.

Wash and dry hands at the sink.

No water dripped on the floor.

14 second dry time.³

HEPA filter captures 99.97% of particles the size of bacteria as small as 0.3 microns.

Tested and certified by NSF International.

Certified for use in food environments by HACCP International.

Costs just \$48 to run per year.⁵

Small carbon footprint.

Saves space.

³ Dry time measured using Dyson test method 769 based on NSF P335 using a measurement of 0.1g residual moisture.

⁴ Loudness reduction compared to the original Dyson Airblade V hand dryer.

⁵ For calculations visit dysoncanada.ca/calcs

A different approach

It all began with James Dyson himself, who wondered if a vacuum cleaner really needed that bag. Later, Dyson engineers discovered hand dryers could dry hands without heat. And fans didn't have to use blades to cool you down.

At Dyson, we've been challenging the conventions of existing technology for over 20 years. Our engineers use this approach every day – helping us invent new machines that simply work better. And we're only just getting started.



Reference

NSF Protocol P335 criteria.
Dyson Airblade™ hand
dryer specifications.

The only hand dryer certified hygienic

NSF certified

Dyson asked independent public health specialists NSF to define the criteria for a hygienic hand dryer. The result is NSF Protocol P335 – and Dyson Airblade™ hand dryers are the only hand dryers that meet every part of it.

Air filtration

Air used to dry hands must be HEPA filtered.

Unheated air

Warming moist bacteria increases their reproduction rate. Heated air can also remove beneficial oils from the skin.

Drying time

Hands must be dried in under 15 seconds. NSF have defined dry as 0.1g of residual moisture. Damp hands can spread up to 1,000 times more bacteria.







Touch-free operation

The hand dryer must start and stop without user contact.

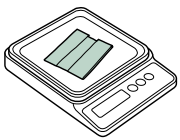
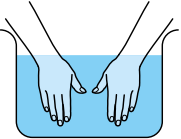

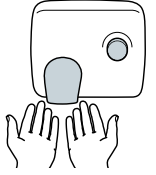
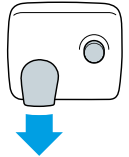
TESTED. CERTIFIED. HYGIENIC

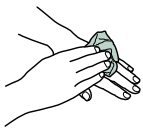
When are dry hands dry? Here's how they test it.

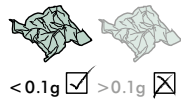
<p>1</p> 	<p>2</p> 	<p>3</p> 	<p>4</p> 
<p>Take three male and female volunteers.</p>	<p>Fold paper towel once, place on digital scales and record weight.</p>	<p>Place both hands in water container up to level of wrist crease for five seconds. Rub hands in the water to remove trapped air and bubbles.</p>	<p>Remove hands from container and let water drip from hands for five seconds.</p>
<p>5</p> 	<p>6</p> 	<p>7</p> 	<p>8</p> 
<p>Place hands under dryer 5cm from outlet. Dry hands according to manufacturer's instructions. If these instructions include rubbing then rub hands at a rate of two times per five seconds.</p>	<p>Once air begins to flow from dryer start to rub and dry hands. Commence drying process by rubbing palms together twice.</p>	<p>Continue drying process by rolling hands twice.</p>	<p>Continue drying process by interlocking and unlocking hands twice.</p>
<p>9</p> 	<p>10</p> 	<p>11</p> 	<p>12</p> 
<p>Remove excess water from hands (between fingers and wrist) with paper towel until hands feel dry. Roll towel into a ball and place on scales within five seconds.</p>	<p>Re-weigh the towel and record the weight.</p>	<p>Repeat the test for all six volunteers and calculate the mean dry time of the six tests.</p>	<p>The machine will be considered 'hygienic' only if the unit can effectively dry hands to less than 0.1g of residual moisture within 15 seconds.</p>
			<p>Anything over 0.1g of moisture means the product will be deemed unhygienic.</p>

Visit the website for full downloadable technical specifications.
www.dysoncanada.ca/docs

REAR ELEVATION

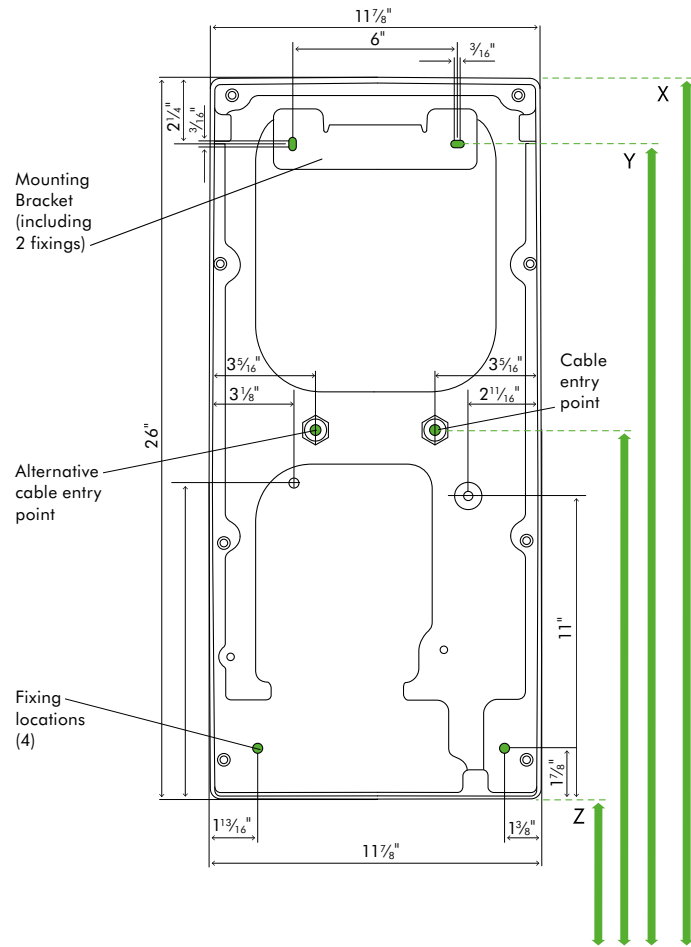

SIDE ELEVATION

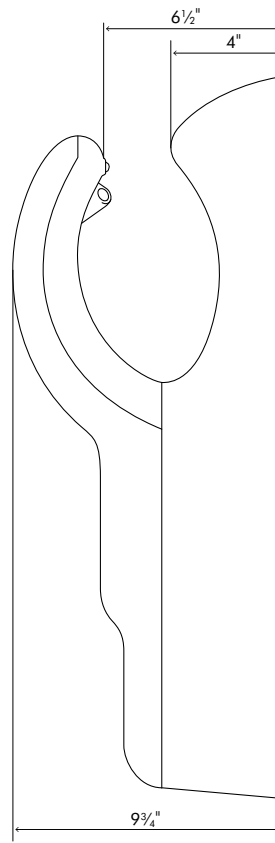

All dimensions shown in inches (+/- 3/16 inches)

FLOOR

Recommended installation heights from floor

Male	X 41 3/8"	Y 39"	Z 15 3/8"
Female	X 38 3/8"	Y 36"	Z 12 3/8"
Child or disabled	X 34 1/2"	Y 32 1/8"	Z 8 1/2"

Machine dimensions

Height 26" Width 11 7/8" Depth 9 3/4"

Visit the website for full downloadable technical specifications.
www.dysoncanada.ca/docs

REAR ELEVATION

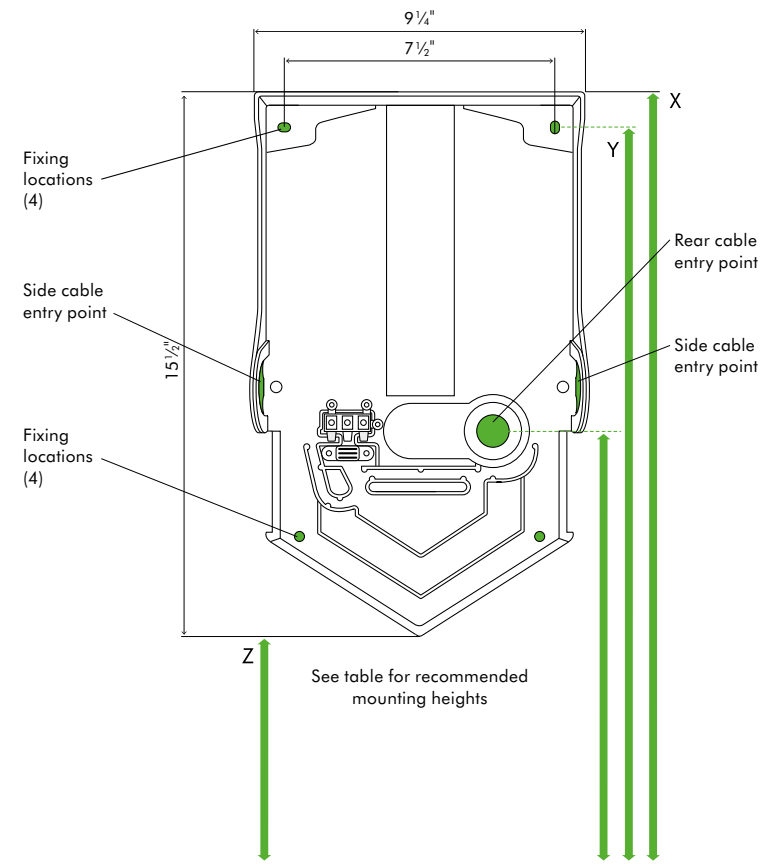

SIDE ELEVATION

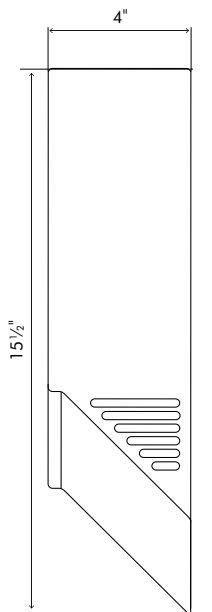

All dimensions shown in inches (+/- 3/16 inches)

FLOOR

Recommended installation heights from floor

Male	X 52 1/8"	Y 51 3/16"	Z 36 5/8"
Female	X 50 3/4"	Y 49 13/16"	Z 35 1/4"
Child or disabled	X 42 5/16"	Y 41 3/8"	Z 26 13/16"

Machine dimensions

Height 15 1/2" Width 9 3/32" Depth 4"

Visit the website for full downloadable technical specifications,
sink recommendations and pre-installation guides.
www.dysoncanada.ca/docs

REAR ELEVATION

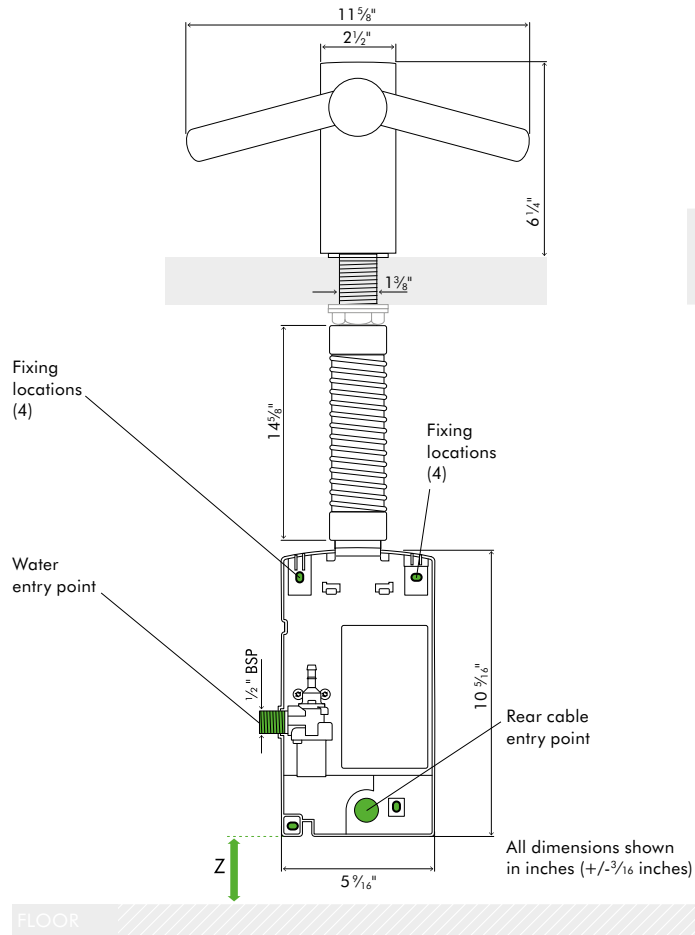

SIDE ELEVATION

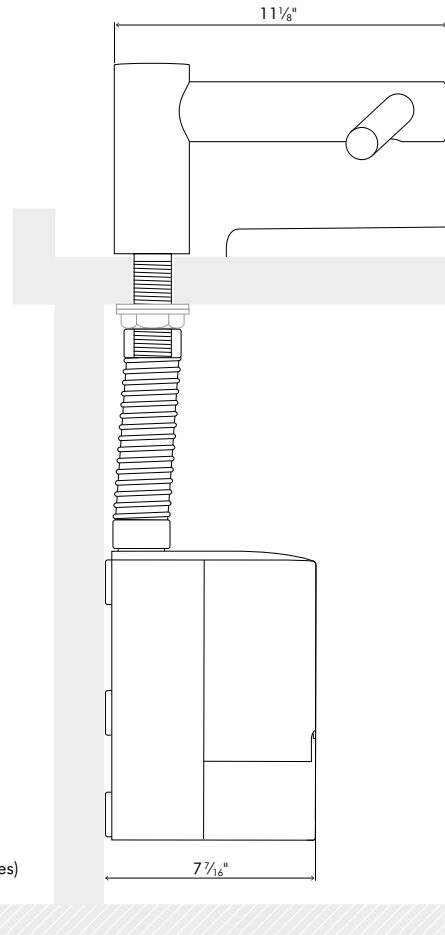

Tap dimensions

AB09 Height 6 1/4" Width 11 5/16" Depth 11 5/16"

Motor bucket dimensions

AB09 Height 10 5/16" Width 5 5/16" Depth 7 1/16"

Minimum clearance

Z 4" clearance from floor. (ADA requires 9" toe clearance)

REAR ELEVATION

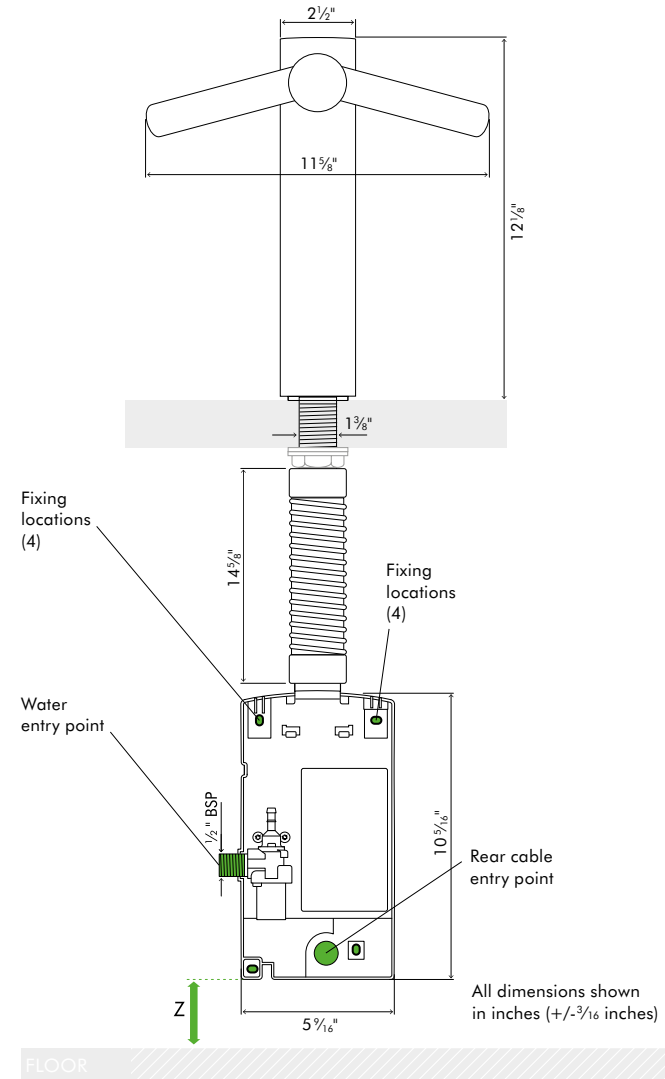

SIDE ELEVATION

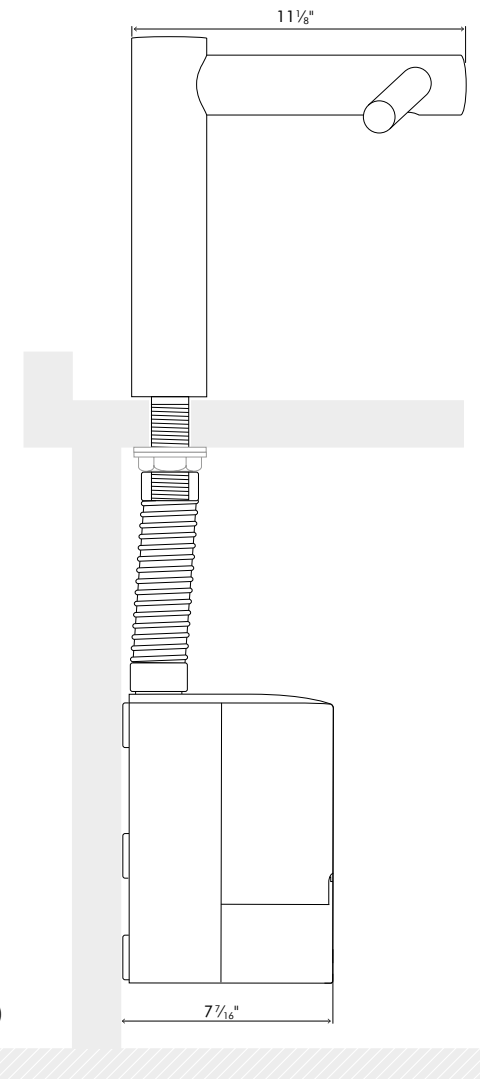

Tap dimensions

AB10 Height 12 1/8" Width 11 5/8" Depth 11 1/8"

Motor bucket dimensions

AB10 Height 10 5/16" Width 5 5/16" Depth 7 1/16"

Minimum clearance

Z 4" clearance from floor. (ADA requires 9" toe clearance)

Visit the website for full downloadable technical specifications, sink recommendations and pre-installation guides.
www.dysoncanada.ca/docs

SIDE ELEVATION

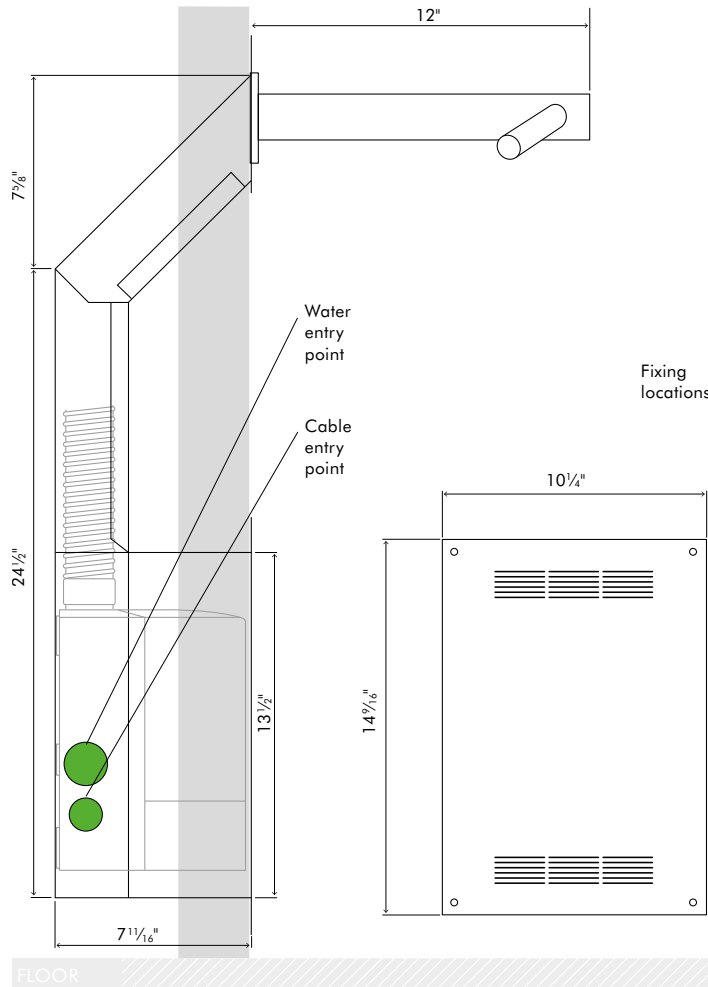

REAR ELEVATION

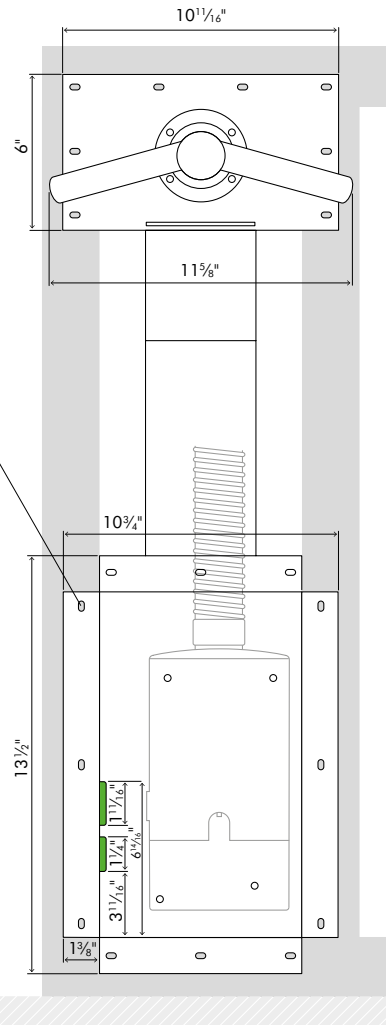

Tap dimensions

AB11 Length 12 1/16" Width 11 5/8"

Motor bucket dimensions

AB11 Height 10 5/16" Width 5 5/16" Depth 7 1/16"

To try the Dyson Airblade™ hand dryer range, or for more information, please call:

1-877-397-6622

commercial.sales@dyson.com

www.dysoncanada.ca

dyson airblade



The Carbon label is a trademark of the Carbon Trust. The NSF logo is the registered trademark of NSF International. HACCP International non-food certification mark is the registered trademark of HACCP International. HACCP International have certified Dyson products based on their recommended installation and operating conditions. Quiet Mark is a registered trademark of the Noise Abatement Society.